

2017
2018



MEASURING INSTRUMENTS

CATALOGUE NO. 102

Сәуір * А [à] à ^ Á Á ^ ! , ã ~ Á æ æ æ * æ \ [&) d ~ { G ð |



QUALITY | INNOVATION | SERVICE | VALUE



The products with this mark are INSIZE PLUS brand

←INSIZE→ is our standard quality and made in Asia – Korea, China, Taiwan, etc.

←INSIZE PLUS→ is our premium quality and mainly made in Germany, UK and Italy



The products with this mark are supplied with manufacturer inspection certificate

←INSIZE→ Inspection Certificate									
Product name		Digital Caliper		Traceable to		USA NIST No.821279484-10			
Code No.		1108-150				Germany DKD No.D-K-15190-01-00			
Measuring range		0-150mm / 0-6"		Inspector		<i>Don</i>			
Resolution		0.01mm / 0.0005"		Judgement		Passed			
Serial No.		0910120004		Standard temperature		20°C / 68°F			
Measuring Length	Permissible Error	Error		Measuring Length	Permissible Error	Error			
		External	Internal			External	Internal		
0.4 DIA	+0.0005 -0.0010	/	0.0005	Φ10	+0.01 -0.02	/	0.01		
2	±0.0010	-0.0005	/	50	±0.02	-0.01	/		
4		-0.0005	/	100		-0.01	/		
6		-0.0010	/	150		-0.02	/		
8	±0.0015	/	/	200	±0.03	/	/		
10		/	/	250		/	/		
12		/	/	300		/	/		



VIDEO

Please scan QR code to watch the basic operation video of the products. For detailed operation video, please enter into <http://www.insize.com/support.php>

How to use PRODUCTION INDEX

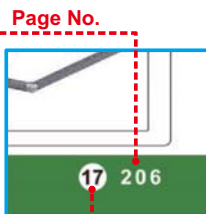

Chapter No.

Page No.



PRODUCT INDEX

1

CALIPER

PAGE 1-23



DIGITAL CALIPER

DIAL CALIPER

VERNIER CALIPER

3

HEIGHT GAGE

PAGE 31-34

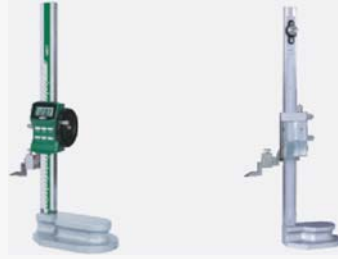

DIGITAL HEIGHT GAGE

VERNIER HEIGHT GAGE

5

BORE AND SHAFT DIAMETER

PAGE 62-88



THREE POINTS
INTERNAL MICROMETER

INSIDE MICROMETER

TUBULAR INSIDE
MICROMETER



BORE PLUG GAGE

BORE GAGE

INTERNAL CHAMFER
GAGE



TELESCOPING GAGE SET

DIGITAL RADIUS GAGE

CIRCUMFERENCE TAPE

8

PAGE 130-150



GAGE BLOCKS

CHECK MASTER

ANGLE GAGE BLOCKS



PIN GAGE

PLAIN PLUG GAGE

THREAD RING/PLUG GAGE

2

DEPTH

PAGE 23-31



DEPTH GAGE

DIAL DEPTH GAGE

DEPTH MICROMETER

4

MICROMETER

PAGE 34-61



DIGITAL OUTSIDE
MICROMETER

OUTSIDE MICROMETER

MICROMETER HEAD

6

INDICATOR

PAGE 88-119



DIGITAL INDICATOR

DIAL INDICATOR

DIAL TEST INDICATOR



MAGNETIC STAND

DIAL INDICATOR STAND

BENCH CENTER

7

PAGE 120-130



INTERNAL/EXTERNAL
CALIPER GAGE

DIGITAL THICKNESS GAGE

DIAL SNAP GAGE



DIGITAL SNAP GAGE

CRANKSHAFT TESTER

9

ANGLE AND STRAIGHTNESS

PAGE 151-160



DIGITAL PROTRACTOR

UNIVERSAL PROTRACTOR

PERPENDICULARITY
TESTER



GRANITE SQUARE

SQUARE

PRECISION STRAIGHT
EDGE

PRODUCT INDEX

10

PAGE 161-179



FEELER GAGE



PITCH GAGE



RADIUS GAGE



CHAMFER GAGE



TAPER GAGE



WELDING GAGE



INSIDE/OUTSIDE CALIPER



MEASURING TAPE



STEEL RULE



COMBINATION SQUARE SET



SCRIBING CALIPER



SCRIBER

13

DATA OUTPUT AND SOFTWARE

PAGE 199-201



MEASURING DATA MANAGEMENT SOFTWARE



DATA OUTPUT CABLE

14

SCALE

PAGE 201-203



DIGITAL SCALE



LINEAR SCALE



COUNTER

16

TOOL PRESETTER

PAGE 205



TOOL PRESETTER

18

PROFILE PROJECTOR

PAGE 207-214



PROFILE PROJECTOR

11

MEASURING TOOL SET

PAGE 180-183



MEASURING TOOL SET

12

PAGE 184-198



GRANITE SURFACE PLATE



V-BLOCK SET



PARALLEL SET



ANGLE PLATE SET



RIGHT ANGLE PLATE



SINE BAR

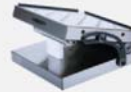

SINE TABLE



PRECISION VISE



CENTERING INDICATOR



3D TESTER



EDGE FINDER



ZERO SETTER

15

LINEAR GAGE

PAGE 204-205



LINEAR GAGE AND DISPLAY UNIT

17

CONTOUR MEASUREMENT

PAGE 206

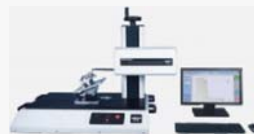

CONTOUR MEASURING MACHINE

19

VISION MEASURING SYSTEM

PAGE 215-216



VISION MEASURING SYSTEM

PRODUCT INDEX

20

MICROSCOPE

PAGE 217-225



ZOOM STEREO MICROSCOPE



DIGITAL MEASURING MICROSCOPE



DIGITAL CAMERA

22

BORESCOPE

PAGE 226-232



VIDEOSCOPE



PIPE VIDEOSCOPE



RIGID BORESCOPE

24

PAGE 241-246



COATING THICKNESS GAGE



CROSS CUT ADHESION TESTER



PULL OFF ADHESION TESTER



DIGITAL SURFACE PROFILE GAGE



WET FILM GAGE

26

EXTERNAL THREAD MEASURING DEVICE

PAGE 253



EXTERNAL THREAD MEASURING DEVICE

28

HARDNESS TESTER

PAGE 259-281



ROCKWELL HARDNESS TESTER



ULTRASONIC HARDNESS TESTER



SHORE DUROMETER TESTER

29

FORCE GAGE

PAGE 282-283



DIGITAL FORCE GAGE



FORCE GAGE



DIAL TENSION GAGE

21

MAGNIFIER

PAGE 225-226



FOLDING MAGNIFIER



MAGNIFIER WITH ILLUMINATION



THREE WAYS MAGNIFIER WITH ILLUMINATION

23

ROUGHNESS TESTER

PAGE 233-241



ROUGHNESS TESTER



SURFACE ROUGHNESS SPECIMEN

25

PAGE 246-252



ULTRASONIC THICKNESS GAGE



LASER DISTANCE METER



INFRARED THERMOMETER



DIGITAL ANEMOMETER



DIGITAL MOISTURE METER



DIGITAL SOUND LEVEL METER



DIGITAL TACHOMETER



GLOSS METER



PORTABLE REFRACTOMETER

27

LEVEL

PAGE 254-259



ELECTRONIC LEVEL



DIGITAL LEVEL AND PROTRACTOR



BLOCK LEVEL

30

**TORQUE TESTER
TORQUE WRENCH**

PAGE 284-293



DIGITAL TORQUE TESTER



DIGITAL BOTTLE CAP TORQUE TESTER



DIGITAL TORQUE SCREWDRIVER



TORQUE SCREWDRIVER



DIGITAL TORQUE WRENCH



TORQUE WRENCH

WATERPROOF DIGITAL CALIPERS

ATTENTION: IT IS NECESSARY TO SET ZERO AFTER POWER ON EACH TIME

ATTENTION: NO DATA OUTPUT

IP67
WATERPROOF

- IP67 dust/waterproof
- Resolution: 0.01mm/0.0005"
- Button function: zero, on/off, mm/inch, ABS/REL, hold
- Battery CR2032
- Meet DIN862
- Made of stainless steel

INSPECTION CERTIFICATE
TRACEABLE TO DKD



1118-150B

Code	Range	Accuracy	Thumb roller	L	a	b	c	d
1118-150B*	0-150mm/0-6"	±0.03mm	with	236	21	16	16	40
1118-200B*	0-200mm/0-8"	±0.03mm	with	286	24	19	16	50
1118-300B*	0-300mm/0-12"	±0.03mm	with	400	25	20.5	17	60
1118-150BW*	0-150mm/0-6"	±0.03mm	without	236	21	16	16	40
1118-200BW*	0-200mm/0-8"	±0.03mm	without	286	24	19	16	50
1118-300BW*	0-300mm/0-12"	±0.03mm	without	400	25	20.5	17	60

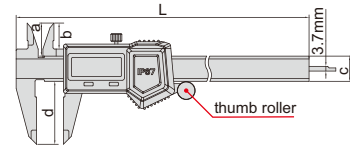

* Supplied with manufacturer inspection certificate traceable to DKD Germany

DIGITAL CALIPERS (ABSOLUTE CODE)

HIGH PRECISION

ABSOLUTE CODE

DATA OUTPUT

- Absolute code
- Resolution: 0.01mm/0.0005"
- Buttons: mm/inch, ABS/REL, on/off, origin set
- Battery CR2032, automatic power off
- After automatic power off, move the digital unit to turn on power
- Data output
- Meet DIN862
- Made of stainless steel
- Optional accessory: data output cable (code 7302-SPC4)

INSPECTION CERTIFICATE
TRACEABLE TO DKD



1103-150

Code	Range	Accuracy	Thumb roller	L	a	b	c	d
1103-150*	0-150mm/0-6"	±0.02mm	with	234	20	15	16	40
1103-200*	0-200mm/0-8"	±0.02mm	with	286	24	19	16	50
1103-300*	0-300mm/0-12"	±0.03mm	with	390	26	21.5	16	60
1103-150W*	0-150mm/0-6"	±0.02mm	without	234	20	15	16	40
1103-200W*	0-200mm/0-8"	±0.02mm	without	286	24	19	16	50
1103-300W*	0-300mm/0-12"	±0.03mm	without	390	26	21.5	16	60

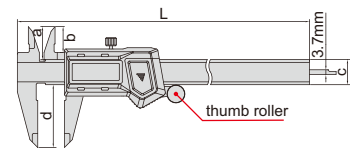

* Supplied with manufacturer inspection certificate traceable to DKD Germany

DIGITAL CALIPERS

INSPECTION CERTIFICATE
TRACEABLE TO DKD

ATTENTION: NO DATA OUTPUT

- Zinc alloy housing for digital unit
- Resolution: 0.01mm/0.0005"
- Buttons: zero, on/off, mm/inch
- Automatic power off, move the digital unit to turn on power
- Battery CR2032
- Meet DIN862
- Made of stainless steel



1114-150A

Code	Range	Accuracy	Thumb roller	L	a	b	c	d
1114-150A*	0-150mm/0-6"	±0.03mm	with	236	21	16	16	40
1114-200A*	0-200mm/0-8"	±0.03mm	with	286	24	19	16	50
1114-300A*	0-300mm/0-12"	±0.03mm	with	400	25	20.5	17	60
1114-150AW*	0-150mm/0-6"	±0.03mm	without	236	21	16	16	40
1114-200AW*	0-200mm/0-8"	±0.03mm	without	286	24	19	16	50
1114-300AW*	0-300mm/0-12"	±0.03mm	without	400	25	20.5	17	60

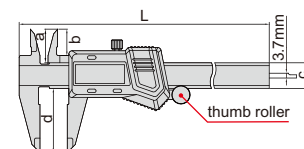

* Supplied with manufacturer inspection certificate traceable to DKD Germany

DATA OUTPUT

DIGITAL CALIPERS (STANDARD MODEL)

INSPECTION CERTIFICATE
TRACEABLE TO DKD

- Resolution: 0.01mm/0.0005"
- Buttons: on/off, zero, mm/inch
- Automatic power off, move the digital unit to turn on power
- Battery CR2032
- Data output
- Meet DIN862
- Made of stainless steel
- Optional accessory: data output cable (code 7306-20, 7302-SPC5A/SPC5B, 7305-SPC2A)



1108-150

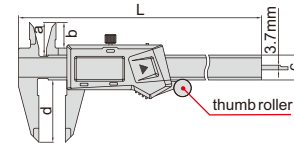

Code	Range	Accuracy	Thumb roller	L	a	b	c	d
1108-150 *	0-150mm/0-6"	±0.02mm	with	236	21	16	16	40
1108-200 *	0-200mm/0-8"	±0.03mm	with	286	24	19	16	50
1108-250 *	0-250mm/0-10"	±0.03mm	with	350	25	20.5	16	60
1108-300 *	0-300mm/0-12"	±0.03mm	with	400	25	20.5	16	60
1108-150W *	0-150mm/0-6"	±0.02mm	without	236	21	16	16	40
1108-200W *	0-200mm/0-8"	±0.03mm	without	286	24	19	16	50
1108-250W *	0-250mm/0-10"	±0.03mm	without	350	25	20.5	16	60
1108-300W *	0-300mm/0-12"	±0.03mm	without	400	25	20.5	16	60

* Supplied with manufacturer inspection certificate traceable to DKD Germany

LOCK READING WITH "HOLD" BUTTON

DATA OUTPUT

METRIC DIGITAL CALIPERS

INSPECTION CERTIFICATE
TRACEABLE TO DKD

- Resolution: 0.01mm
- Buttons: on/off, zero, hold
- Automatic power off, move the digital unit to turn on power
- Battery CR2032
- Data output
- Meet DIN862
- Made of stainless steel
- Optional accessory: data output cable (code 7306-20, 7302-SPC5A/SPC5B, 7305-SPC2A)



1109-150

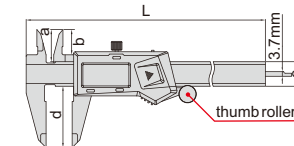

Code	Range	Accuracy	Thumb roller	L	a	b	c	d
1109-150 *	0-150mm	±0.03mm	with	236	21	16	16	40
1109-200 *	0-200mm	±0.03mm	with	286	24	19	16	50
1109-300 *	0-300mm	±0.03mm	with	400	25	20.5	16	60
1109-150W *	0-150mm	±0.03mm	without	236	21	16	16	40
1109-200W *	0-200mm	±0.03mm	without	286	24	19	16	50
1109-300W *	0-300mm	±0.03mm	without	400	25	20.5	16	60

* Supplied with manufacturer inspection certificate traceable to DKD Germany

DATA OUTPUT

DIGITAL CALIPERS WITH ROUND DEPTH BAR

INSPECTION CERTIFICATE
TRACEABLE TO DKD

- Resolution: 0.01mm/0.0005"
- Buttons: on/off, zero, mm/inch
- Automatic power off, move the digital unit to turn on power
- Battery CR2032
- Data output
- Meet DIN862
- Made of stainless steel
- Optional accessory: data output cable (code 7306-20, 7302-SPC5A/SPC5B, 7305-SPC2A)



1119-150

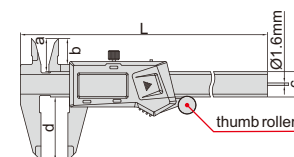

Code	Range	Accuracy	Thumb roller	L	a	b	c	d
1119-150 *	0-150mm/0-6"	±0.03mm	with	236	21	16	16	40
1119-150W *	0-150mm/0-6"	±0.03mm	without	236	21	16	16	40

* Supplied with manufacturer inspection certificate traceable to DKD Germany

DIGITAL CALIPERS WITH CARBIDE TIPPED JAWS

**INSPECTION
CERTIFICATE**
TRACEABLE TO DKD

DATA
OUTPUT

- Carbide tipped jaws for inside and outside measurements
- Resolution: 0.01mm/0.0005"
- Buttons: on/off, zero, mm/inch
- Automatic power off, move the digital unit to turn on power
- Battery CR2032, data output, meet DIN862
- Made of stainless steel
- Optional accessory: data output cable
(code 7306-20, 7302-SPC5A/SPC5B, 7305-SPC2A)



1110-150A

Code	Range	Accuracy	Thumb roller	L	a	b	c	d	(mm)
1110-150A*	0-150mm/0-6"	±0.03mm	with	236	21	16	16	40	
1110-200A*	0-200mm/0-8"	±0.03mm	with	286	24	19	16	50	
1110-300A*	0-300mm/0-12"	±0.03mm	with	400	25	20.5	16	60	
1110-150AW*	0-150mm/0-6"	±0.03mm	without	236	21	16	16	40	
1110-200AW*	0-200mm/0-8"	±0.03mm	without	286	24	19	16	50	
1110-300AW*	0-300mm/0-12"	±0.03mm	without	400	25	20.5	16	60	

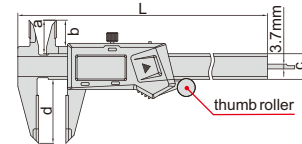

* Supplied with manufacturer inspection certificate traceable to DKD Germany

DIGITAL CALIPERS WITH CERAMIC TIPPED JAWS

**INSPECTION
CERTIFICATE**
TRACEABLE TO DKD

DATA
OUTPUT

- Ceramic tipped jaws for outside measurement, extremely wear-resistant, non-magnetic, non-conductive
- Resolution: 0.01mm/0.0005"
- Buttons: on/off, zero, mm/inch
- Automatic power off, move the digital unit to turn on power
- Battery CR2032, data output, made of stainless steel
- Meet DIN862
- Optional accessory: data output cable
(code 7306-20, 7302-SPC5A/SPC5B, 7305-SPC2A)

ceramic
tipped jaws



1193-150

Code	Range	Accuracy	Thumb roller	L	a	b	c	d	(mm)
1193-150*	0-150mm/0-6"	±0.03mm	with	235	21	16.5	16	40	
1193-200*	0-200mm/0-8"	±0.03mm	with	297	24	20	16	50	
1193-300*	0-300mm/0-12"	±0.03mm	with	390	26	21.5	16	60	
1193-150W*	0-150mm/0-6"	±0.03mm	without	235	21	16.5	16	40	
1193-200W*	0-200mm/0-8"	±0.03mm	without	297	24	20	16	50	
1193-300W*	0-300mm/0-12"	±0.03mm	without	390	26	21.5	16	60	

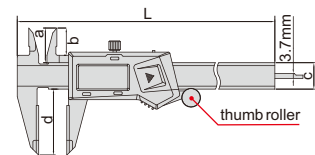

* Supplied with manufacturer inspection certificate traceable to DKD Germany

LEFT HAND DIGITAL CALIPERS

**INSPECTION
CERTIFICATE**
TRACEABLE TO DKD

DATA
OUTPUT

- Designed for left handed users
- Resolution: 0.01mm/0.0005"
- Buttons: on/off, zero, mm/inch
- Automatic power off, move the digital unit to turn on power
- Battery CR2032
- Data output
- Meet DIN862
- Made of stainless steel
- Optional accessory: data output cable
(code 7306-20, 7302-SPC5A/SPC5B, 7305-SPC2A)



1130-150

Code	Range	Accuracy	Thumb roller	L	a	b	c	d	(mm)
1130-150*	0-150mm/0-6"	±0.03mm	with	236	21	16	16	40	
1130-200*	0-200mm/0-8"	±0.03mm	with	286	24	19	16	50	
1130-300*	0-300mm/0-12"	±0.03mm	with	400	25	20.5	17	60	
1130-150W*	0-150mm/0-6"	±0.03mm	without	236	21	16	16	40	
1130-200W*	0-200mm/0-8"	±0.03mm	without	286	24	19	16	50	
1130-300W*	0-300mm/0-12"	±0.03mm	without	400	25	20.5	17	60	

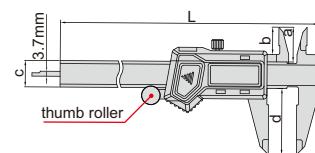

* Supplied with manufacturer inspection certificate traceable to DKD Germany

MINI DIGITAL CALIPERS

- Resolution: 0.01mm/0.0005"
- Buttons: zero, mm/inch, on/off
- Automatic power off, move the digital unit to turn on power
- Battery LR44
- Meet DIN862
- Made of stainless steel



1111-100A

ATTENTION:
NO DATA OUTPUT

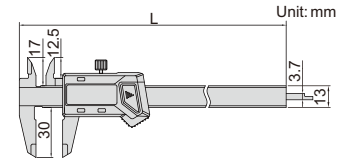

Code	Range	Accuracy	L
1111-75A	0-75mm/0-3"	±0.02mm	144mm
1111-100A	0-100mm/0-4"	±0.02mm	170mm

DIGITAL CALIPERS

DATA
OUTPUT

- Resolution: 0.01mm/0.0005"
- Buttons: on/off, zero, mm/inch
- Automatic power off, move the digital unit to turn on power
- Battery CR2032
- Data output
- Made of stainless steel
- Optional accessory: data output cable (code 7306-20, 7302-SPC5A/SPC5B, 7305-SPC2A)



1171-300

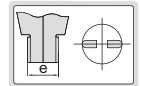
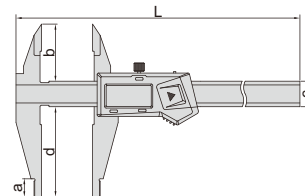

Code	Range	Accuracy	a	b	c	d	e	L
1171-200	0-200mm/0-8"	±0.03mm	12	38	17	60	10	320
1171-306	0-300mm/0-12"	±0.04mm	12	38	17	60	10	420
1171-300	0-300mm/0-12"	±0.04mm	12	38	17	90	10	420

DIGITAL CALIPERS

DATA
OUTPUT

- Resolution: 0.01mm/0.0005"
- Buttons: on/off, zero, mm/inch
- Automatic power off, move the digital unit to turn on power
- Battery CR2032
- Data output
- Made of stainless steel
- Optional accessory: data output cable (code 7306-20, 7302-SPC5A/SPC5B, 7305-SPC2A)



1170-300

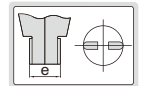
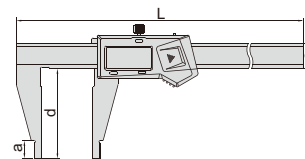

Code	Range	Accuracy	a	c	d	e	L
1170-200	0-200mm/0-8"	±0.03mm	12	17	60	10	320
1170-306	0-300mm/0-12"	±0.04mm	12	17	60	10	420
1170-300	0-300mm/0-12"	±0.04mm	12	17	90	10	420

PLASTIC DIGITAL CALIPER

- Made of hard plastic, non-magnetic and non-conductive
- Prevent workpieces from scratching by calipers
- Resolution: 0.01mm/0.0005"
- Buttons: on/off, zero, mm/inch
- Battery CR2032, automatic power off



1139-150

ATTENTION:
NO DATA OUTPUT

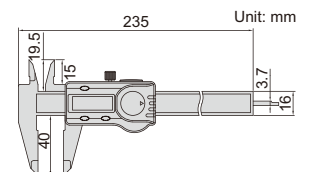

Code	Range	Accuracy
1139-150	0-150mm/0-6"	±0.1mm

DIAL CALIPERS

**INSPECTION
CERTIFICATE**
TRACEABLE TO DKD

**SHOCK
PROOF**

- Shockproof dial indicator
- Made of stainless steel



1312-150A

Dial indicator graduation: 0.02mm (mm)

Code	Range	Accuracy	Thumb roller	L	a	b	c	d	D	t
1312-150A*	0-150mm	±0.03mm	with	235	21	16.5	16	40	∅39	6.5
1312-200A*	0-200mm	±0.03mm	with	288	24	19	16	48	∅39	6.5
1312-300A*	0-300mm	±0.03mm	with	410	28	22	20	62	∅44.5	7.5
1312-150AW*	0-150mm	±0.03mm	without	235	21	16.5	16	40	∅39	6.5
1312-200AW*	0-200mm	±0.03mm	without	288	24	19	16	48	∅39	6.5
1312-300AW*	0-300mm	±0.03mm	without	410	28	22	20	62	∅44.5	7.5

Dial indicator graduation: 0.01mm (mm)

Code	Range	Accuracy	Thumb roller	L	a	b	c	d	D	t
1311-150A*	0-150mm	±0.03mm	with	235	21	16.5	16	40	∅39	6.5
1311-200A*	0-200mm	±0.03mm	with	288	24	19	16	48	∅39	6.5
1311-300A*	0-300mm	±0.03mm	with	410	28	22	20	62	∅44.5	7.5
1311-150AW*	0-150mm	±0.03mm	without	235	21	16.5	16	40	∅39	6.5
1311-200AW*	0-200mm	±0.03mm	without	288	24	19	16	48	∅39	6.5
1311-300AW*	0-300mm	±0.03mm	without	410	28	22	20	62	∅44.5	7.5

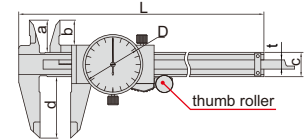

* Supplied with manufacturer inspection certificate traceable to DKD Germany

MINI VERNIER CALIPER

- Meet DIN862
- Made of stainless steel
- Satin chrome plated reading surface

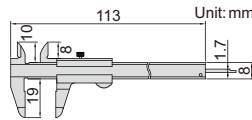

1204-70

Code	Range	Graduation	Accuracy
1204-70	0-70mm	0.05mm	±0.05mm

MINI VERNIER CALIPER

- Meet DIN862
- Made of stainless steel
- Satin chrome plated reading surface

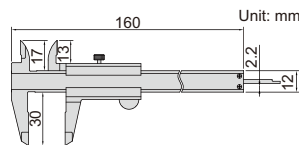

1203-1003

Code	Range	Graduation	Accuracy
1203-1003	0-100mm	0.05mm	±0.05mm

MINI VERNIER CALIPER

- Meet DIN862
- Made of stainless steel
- Satin chrome plated reading surface

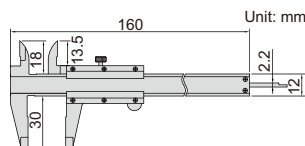

1201-1003

Code	Range	Graduation	Accuracy
1201-1003	0-100mm	0.05mm	±0.05mm

VERNIER CALIPERS

Graduation 0.05mm/1/128" (mm)

Code	Range	Accuracy	L	a	b	c	d
1205-150S	0-150mm/0-6"	±0.05mm	235	20.5	15.5	16	40
1205-200S	0-200mm/0-8"	±0.05mm	290	23.5	19	17	50
1205-250S	0-250mm/0-10"	±0.05mm	364	27.5	22	20	64
1205-300S	0-300mm/0-12"	±0.05mm	414	27.5	22	20	64

Graduation 0.05mm (mm)

Code	Range	Accuracy	L	a	b	c	d
1205-1503S	0-150mm	±0.05mm	235	20.5	15.5	16	40
1205-2003S	0-200mm	±0.05mm	290	23.5	19	17	50
1205-3003S	0-300mm	±0.05mm	414	27.5	22	20	64

Graduation 0.02mm/0.001" (mm)

Code	Range	Accuracy	L	a	b	c	d
1205-1502S	0-150mm/0-6"	±0.03mm	235	20.5	15.5	16	40
1205-2002S	0-200mm/0-8"	±0.03mm	290	23.5	19	17	50
1205-2502S	0-250mm/0-10"	±0.03mm	364	27.5	22	20	64
1205-3002S	0-300mm/0-12"	±0.03mm	414	27.5	22	20	64

Graduation 0.02mm (mm)

Code	Range	Accuracy	L	a	b	c	d
1205-1501S	0-150mm	±0.03mm	235	20.5	15.5	16	40
1205-2001S	0-200mm	±0.03mm	290	23.5	19	17	50
1205-3001S	0-300mm	±0.03mm	414	27.5	22	20	64



1205-150S

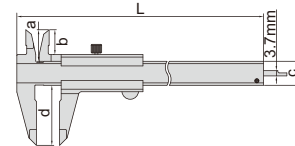

- Meet DIN862
- Made of stainless steel
- Satin chrome plated reading surface

VERNIER CALIPER WITH ROUND DEPTH BAR

- Graduation 0.05mm/1/128"
- Round depth bar
- Meet DIN862
- Made of stainless steel
- Satin chrome plated reading surface



1202-150

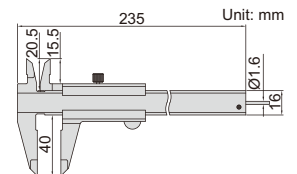

Code	Range	Accuracy
1202-150	0-150mm/0-6"	±0.05mm

VERNIER CALIPERS WITH FINE ADJUSTMENT

- Graduation 0.02mm/0.001"
- With fine adjustment
- Meet DIN862
- Made of stainless steel
- Satin chrome plated reading surface



1233-130

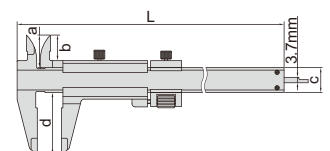

Code	Range	Accuracy	L	a	b	c	d
1233-130	0-130mm/0-5"	±0.03mm	230	20.5	16.5	16	40
1233-180	0-180mm/0-7"	±0.03mm	295	23.5	19	16	50
1233-280	0-280mm/0-11"	±0.03mm	410	26	20	20	60

VERNIER CALIPERS WITH THUMB CLAMP

- Meet DIN862
- With thumb clamp
- Made of stainless steel
- Satin chrome plated reading surface

Graduation 0.05mm/1/128" (mm)

Code	Range	Accuracy	L	a	b	c	d
1223-150	0-150mm/0-6"	±0.05mm	230	20.5	16.5	16	40
1223-200	0-200mm/0-8"	±0.05mm	295	23.5	19	16	50
1223-300	0-300mm/0-12"	±0.05mm	405	26	20	20	60

Graduation 0.02mm/0.001" (mm)

Code	Range	Accuracy	L	a	b	c	d
1223-1502	0-150mm/0-6"	±0.03mm	230	20.5	16.5	16	40
1223-2002	0-200mm/0-8"	±0.03mm	295	23.5	19	16	50
1223-3002	0-300mm/0-12"	±0.03mm	405	26	20	20	60



1223-150

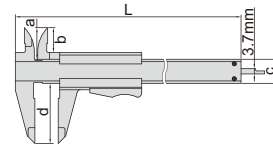

VERNIER CALIPERS WITH CARBIDE TIPPED JAWS

- Carbide tipped jaws for inside and outside measurements
- Meet DIN862
- Made of stainless steel
- Satin chrome plated reading surface

Graduation 0.05mm/1/128" (mm)

Code	Range	Accuracy	L	a	b	c	d
1238-150	0-150mm/0-6"	±0.05mm	230	21	16.5	16	40
1238-200	0-200mm/0-8"	±0.05mm	295	24	19	16	50
1238-300	0-300mm/0-12"	±0.05mm	410	25	20	17	60

Graduation 0.02mm/0.001" (mm)

Code	Range	Accuracy	L	a	b	c	d
1238-1502	0-150mm/0-6"	±0.03mm	230	21	16.5	16	40
1238-2002	0-200mm/0-8"	±0.03mm	295	24	19	16	50
1238-3002	0-300mm/0-12"	±0.03mm	410	25	20	17	60



1238-150

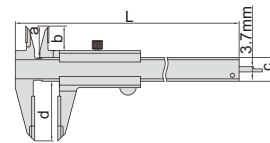

VERNIER CALIPER

- Graduation 0.02mm
- With fine adjustment
- Made of stainless steel
- Satin chrome plated reading surface



1217-3001

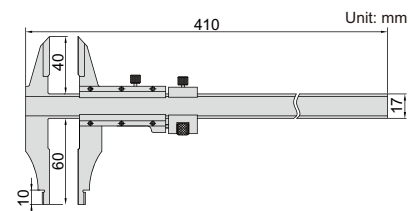

Code	Range	Accuracy
1217-3001	0-300mm	±0.03mm

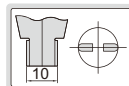

ATTENTION:
NOT HARDENED

VERNIER CALIPERS (ANTI MAGNETIC)

- Suitable for magnetic parts
- Graduation: 0.02mm
- Made of stainless steel
- Satin chrome plated reading surface
- Measuring faces are not hardened, HRC18-22



1224-201

(mm)							
Code	Range	Accuracy	a	c	d	e	L
1224-151	0-150mm	±0.04mm	10	17	50	10	250
1224-201	0-200mm	±0.04mm	10	17	50	10	300
1224-361	0-300mm	±0.04mm	10	17	60	10	400

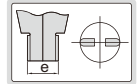
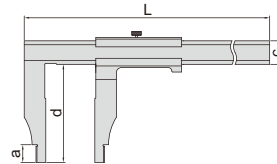

DEPTH BASE ATTACHMENTS

- To increase the stability of depth measurement
- Suitable for digital calipers and dial calipers
- Made of stainless steel

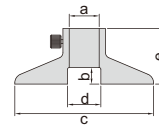

6140

(mm)						
Code	a	b	c	d	e	Application
6140	16.5	9	75	18	30	Suitable for calipers with beam width (w) 16mm
6140-300A	20	15	125	22	34	Suitable for calipers with beam width (w) 20mm

**ACCESSORY SET FOR DIGITAL CALIPERS
CODE 6144**



6144

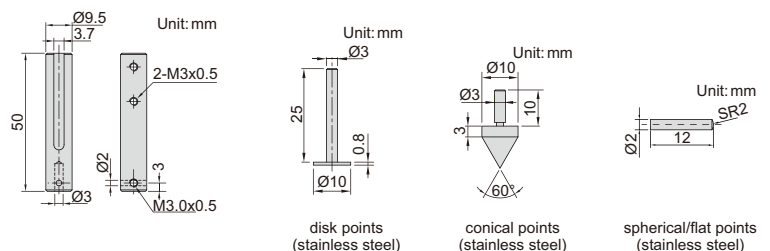

- Suitable for 0-150mm/0-6" and 0-200mm/0-8" digital calipers (thickness of lower jaws < 3.7mm)

Code
6144

DIGITAL CALIPERS

(mm)

Code	Range	Accuracy	a	c	d	e	L
1106-301	0-300mm/0-12"	±0.05mm	18	24	100	20	420
1106-302	0-300mm/0-12"	±0.05mm	18	24	150	20	420
1106-451	0-450mm/0-18"	±0.05mm	18	24	100	20	625
1106-501	0-500mm/0-20"	±0.05mm	18	24	100	20	675
1106-502	0-500mm/0-20"	±0.06mm	18	24	150	20	675
1106-503	0-500mm/0-20"	±0.06mm	24	31	200	20	675
1106-505	0-500mm/0-20"	±0.08mm	24	42	300	20	675
1106-601	0-600mm/0-24"	±0.05mm	18	24	100	20	770
1106-602	0-600mm/0-24"	±0.06mm	18	24	150	20	770
1106-603	0-600mm/0-24"	±0.06mm	24	31	200	20	770
1106-802	0-800mm/0-32"	±0.07mm	24	31	150	20	1025
1106-1002	0-1000mm/0-40"	±0.08mm	24	31	150	20	1220
1106-1003	0-1000mm/0-40"	±0.08mm	24	31	200	20	1220
1106-1005	0-1000mm/0-40"	±0.10mm	24	42	300	20	1220
1106-1502	0-1500mm/0-60"	±0.11mm	24	42	150	20	1780
1106-1503	0-1500mm/0-60"	±0.12mm	24	42	200	20	1780
1106-2002	0-2000mm/0-80"	±0.14mm	24	42	150	20	2290
1106-2003	0-2000mm/0-80"	±0.14mm	24	42	200	20	2290
1106-2502	0-2500mm/0-100"	±0.22mm	24	42	150	20	2800
1106-3002	0-3000mm/0-120"	±0.26mm	24	42	150	20	3300

DATA OUTPUT



1106-501

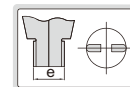
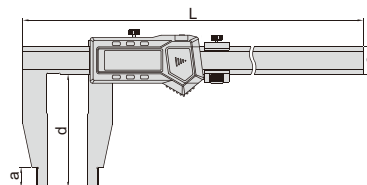

- Resolution: 0.01mm/0.0005"
- Button function: on/off, zero, mm/inch, ABS, data preset
- Battery CR2032
- Data output
- Made of stainless steel
- Optional accessory: data output cable (code 7306-20, 7302-SPC5A/SPC5B, 7305-SPC2A)

DIGITAL CALIPERS

- Resolution: 0.01mm/0.0005"
- Button function: on/off, zero, mm/inch, ABS, data preset
- Battery CR2032
- Data output
- Made of stainless steel
- Optional accessory: data output cable (code 7306-20, 7302-SPC5A/SPC5B, 7305-SPC2A)

(mm)

Code	Range	Accuracy	a	b	c	d	e	L
1117-301	0-300mm/0-12"	±0.05mm	18	56	24	100	20	420
1117-501	0-500mm/0-20"	±0.05mm	18	56	24	100	20	675
1117-502	0-500mm/0-20"	±0.06mm	18	56	24	150	20	675
1117-601	0-600mm/0-24"	±0.05mm	18	56	24	100	20	770
1117-802	0-800mm/0-32"	±0.07mm	24	67	31	150	20	1025
1117-1002	0-1000mm/0-40"	±0.08mm	24	67	31	150	20	1220

DATA OUTPUT



1117-501

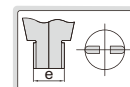
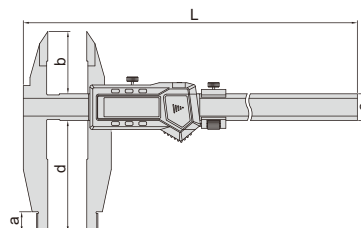

DIGITAL CALIPERS

- Resolution: 0.01mm/0.0005"
- Button function: on/off, zero, mm/inch, ABS, data preset
- Battery CR2032
- Data output
- Made of stainless steel
- Optional accessory: data output cable (code 7306-20, 7302-SPC5A/SPC5B, 7305-SPC2A)

(mm)

Code	Range	Accuracy	a	b	c	d	e	L
1136-301	0-300mm/0-12"	±0.05mm	18	45	24	100	20	420
1136-451	0-450mm/0-18"	±0.05mm	18	45	24	100	20	625
1136-501	0-500mm/0-20"	±0.05mm	18	45	24	100	20	675
1136-502	0-500mm/0-20"	±0.06mm	18	45	24	150	20	675
1136-503	0-500mm/0-20"	±0.06mm	24	60	31	200	20	675
1136-601	0-600mm/0-24"	±0.05mm	18	45	24	100	20	770
1136-1002	0-1000mm/0-40"	±0.08mm	24	60	31	150	20	1220
1136-1502	0-1500mm/0-60"	±0.11mm	24	60	42	150	20	1780
1136-2002	0-2000mm/0-80"	±0.14mm	24	60	42	150	20	2290

DATA OUTPUT



1136-501

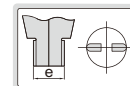
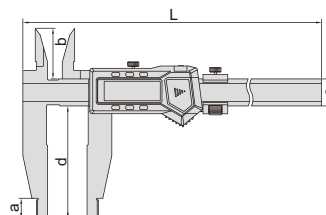

DATA OUTPUT

- Resolution: 0.01mm/0.0005"
- Button function: on/off, zero, mm/inch, ABS, data preset
- Battery CR2032
- Data output
- Made of stainless steel
- Optional accessory: data output cable (code 7306-20, 7302-SPC5A/SPC5B, 7305-SPC2A)

Code	Range	Accuracy	a	c	d	L
1135-451	0-450mm/0-18"	±0.05mm	45	24	100	625
1135-601	0-600mm/0-24"	±0.05mm	45	24	100	770
1135-1002	0-1000mm/0-40"	±0.08mm	60	31	150	1220



1135-601

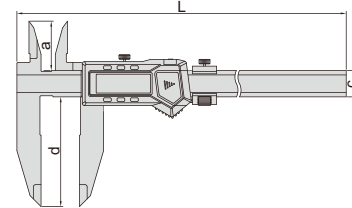

VERNIER CALIPERS (SOLID TYPE)

- With fine adjustment
- Made of stainless steel
- Satin chrome plated reading surface

Graduation 0.05mm/1/128" (mm)

Code	Range	Accuracy	a	b	c	d	e	L
1236-394	0-300mm/0-12"	±0.07mm	12	38	20	90	10	450
1236-514	0-500mm/0-20"	±0.07mm	18	45	24	100	20	670
1236-524	0-500mm/0-20"	±0.08mm	18	45	24	150	20	670
1236-614	0-600mm/0-24"	±0.08mm	18	45	24	100	20	770
1236-824	0-800mm/0-32"	±0.09mm	24	60	31	150	20	1030
1236-1024	0-1000mm/0-40"	±0.12mm	24	60	31	150	20	1230



1236-521

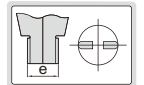
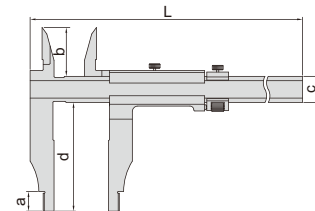

Graduation 0.02mm (mm)

Code	Range	Accuracy	a	b	c	d	e	L
1236-511	0-500mm	±0.05mm	18	45	24	100	20	670
1236-521	0-500mm	±0.06mm	18	45	24	150	20	670
1236-1021	0-1000mm	±0.08mm	24	60	31	150	20	1230

VERNIER CALIPERS (SOLID TYPE)

- Graduation 0.05mm/1/128"
- With fine adjustment
- Made of stainless steel
- Satin chrome plated reading surface



1207-514

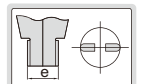
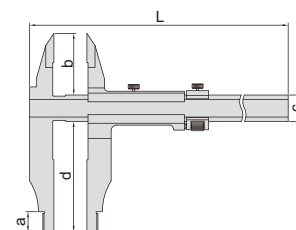

(mm)

Code	Range	Accuracy	a	b	c	d	e	L
1207-394	0-300mm/0-12"	±0.07mm	12	40	20	90	10	440
1207-514	0-500mm/0-20"	±0.07mm	18	56	24	100	20	670
1207-524	0-500mm/0-20"	±0.08mm	18	56	24	150	20	670
1207-824	0-800mm/0-32"	±0.09mm	24	67	31	150	20	930
1207-1024	0-1000mm/0-40"	±0.12mm	24	67	31	150	20	1230

VERNIER CALIPERS (SOLID TYPE)

Graduation 0.05mm/1/128" (mm)

Code	Range	Accuracy	a	c	d	e	L
1208-214	0-200mm/0-8"	±0.06mm	10	20	100	10	330
1208-394	0-300mm/0-12"	±0.07mm	10	20	90	10	410
1208-324	0-300mm/0-12"	±0.07mm	18	24	150	20	410
1208-524	0-500mm/0-20"	±0.08mm	18	24	150	20	670
1208-614	0-600mm/0-24"	±0.08mm	18	24	100	20	770
1208-624	0-600mm/0-24"	±0.09mm	18	24	150	20	770
1208-824	0-800mm/0-32"	±0.09mm	24	31	150	20	1030
1208-1024	0-1000mm/0-40"	±0.12mm	24	31	150	20	1230
1208-1524	0-1500mm/0-60"	±0.16mm	24	42	150	20	1820
1208-2024	0-2000mm/0-80"	±0.20mm	24	42	150	20	2330

Graduation 0.02mm (mm)

Code	Range	Accuracy	a	c	d	e	L
1208-511	0-500mm	±0.05mm	18	24	100	20	670
1208-521	0-500mm	±0.06mm	18	24	150	20	670
1208-1021	0-1000mm	±0.08mm	24	31	150	20	1230
1208-1521	0-1500mm	±0.11mm	24	42	150	20	1820



1208-511

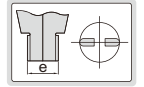
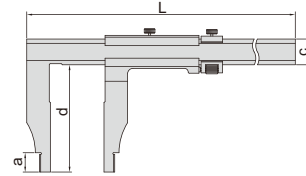

- With fine adjustment
- Made of stainless steel
- Satin chrome plated reading surface

VERNIER CALIPERS (SOLID TYPE)

- With fine adjustment
- Made of stainless steel
- Satin chrome plated reading surface

Graduation 0.05mm/1/128" (mm)

Code	Range	Accuracy	a	c	d	L
1210-614	0-600mm/0-24"	±0.08mm	45	24	100	770
1210-1024	0-1000mm/0-40"	±0.12mm	60	31	150	1230

Graduation 0.02mm (mm)

Code	Range	Accuracy	a	c	d	L
1210-611	0-600mm	±0.05mm	45	24	100	770
1210-1021	0-1000mm	±0.08mm	60	31	150	1230



1210-611

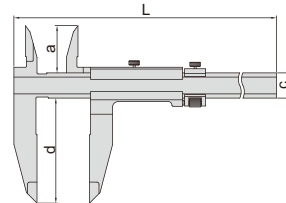

VERNIER CALIPERS

- With fine adjustment
- Made of stainless steel
- Satin chrome plated reading surface

Graduation 0.02mm/0.001" (mm)

Code	Range	Accuracy	a	c	d	e	L
1214-300	0-300mm/0-12"	±0.05mm	10	20	75	10	410
1214-450	0-450mm/0-18"	±0.05mm	18	24	100	20	620
1214-500	0-500mm/0-20"	±0.05mm	18	24	100	20	670
1214-600	0-600mm/0-24"	±0.05mm	18	24	100	20	770
1214-1000	0-1000mm/0-40"	±0.08mm	24	32	140	20	1216
1214-1500	0-1500mm/0-60"	±0.12mm	24	42	200	20	1830
1214-2000	0-2000mm/0-80"	±0.14mm	24	42	200	20	2320

Graduation 0.05mm/1/128" (mm)

Code	Range	Accuracy	a	c	d	e	L
1214-6004	0-600mm/0-24"	±0.08mm	18	24	100	20	770
1214-1004	0-1000mm/0-40"	±0.12mm	24	32	140	20	1216



1214-500

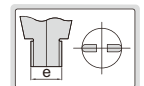
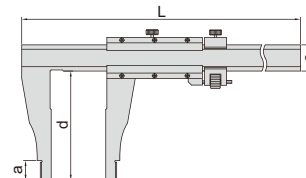

LONG JAW VERNIER CALIPERS

Graduation 0.02mm/0.001"

(mm)

Code	Range	Accuracy	a	c	d	e	L
1215-392	0-300mm/0-12"	±0.05mm	10	17	90	10	410
1215-322	0-300mm/0-12"	±0.05mm	18	24	150	20	470
1215-522	0-500mm/0-20"	±0.06mm	18	24	150	20	670
1215-532	0-500mm/0-20"	±0.06mm	18	24	200	20	670
1215-622	0-600mm/0-24"	±0.06mm	18	24	150	20	770
1215-642	0-600mm/0-24"	±0.08mm	24	32	250	20	870
1215-822	0-800mm/0-32"	±0.07mm	24	32	150	20	1020
1215-832	0-800mm/0-32"	±0.07mm	24	32	200	20	1020
1215-1032	0-1000mm/0-40"	±0.08mm	24	32	200	20	1220
1215-1052	0-1000mm/0-40"	±0.11mm	24	42	300	20	1330
1215-3052	0-3000mm/0-120"	±0.26mm	24	50	300	20	3360



1215-1032

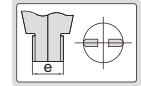
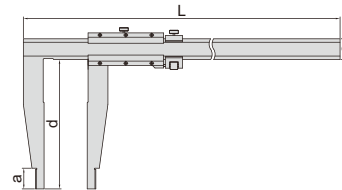

Graduation 0.05mm/1/128"

(mm)

Code	Range	Accuracy	a	c	d	e	L
1215-524	0-500mm/0-20"	±0.08mm	18	24	150	20	670
1215-1034	0-1000mm/0-40"	±0.12mm	24	32	200	20	1330

- With fine adjustment
- Made of stainless steel
- Satin chrome plated reading surface

CUSTOM-MADE CALIPERS



- We are able to make calipers according to the design from customers

SET BUTTON

- In some calipers, there is a "SET" button. It is possible to set a initial reading (instead of zero) on these calipers.
- For internal measurement, if the size L is unknown, it is necessary to set. After setting, you can get a direct reading, without adding L.
 Step 1: Find a micrometer, set it at a number (for example, 25mm) and lock it.
 Step 2: Press "SET", "+" and "-" buttons to set 25 on caliper. After setting, the initial reading will be 25 instead of zero, when "SET" is pressed anytime.
 Step 3: Put caliper into the micrometer, press "SET", the reading is 25.



VIDEO

SET button



size L



step 1



step 2



step 3



- For external measurement, if the tips are spherical, it is difficult to set zero because the two tips may not be aligned.
 Step 1: Find a gage block (for example, 10mm).
 Step 2: Press "SET", "+" and "-" buttons to set 10mm on caliper. After setting, the initial reading will be 10mm instead of zero, when SET is pressed anytime.
 Step 3: Hold the gage block, press "SET", the reading is 10mm.

spherical tips



step 1



step 2



step 3



UNIVERSAL CALIPER CODE 1125-600

DATA
OUTPUT



working with stands



working with measuring jaws



1125-600

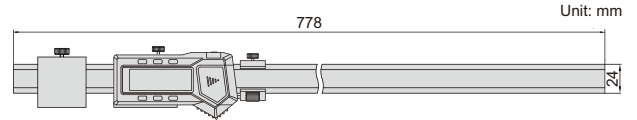

- Buttons: on/off, set, mm/inch, ABS, preset (+, -)
- Automatic power off, move the digital unit to turn on power
- Battery CR2032
- Data output
- Made of stainless steel
- Optional accessory: data output cable (code 7306-20, 7302-SPC5A/SPC5B, 7305-SPC2A)

Code	Range*	Resolution	Accuracy
1125-600	0-600mm/0-24"	0.01mm/0.0005"	±0.05mm

*The range changes according to different points

Half disk points (included)

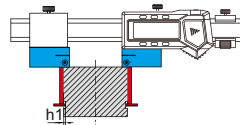
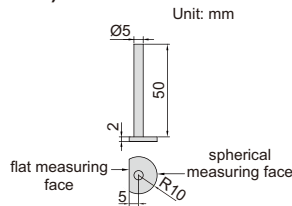

Measuring external groove diameter with flat measuring face (depth $h1 \leq 2.5\text{mm}$)

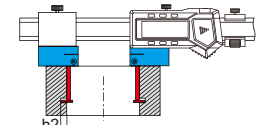

Measuring internal groove diameter with spherical measuring face (depth $h2 \leq 7.5\text{mm}$)

Conical points (optional)

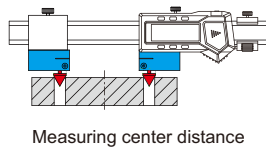
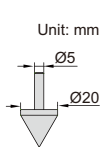

Measuring center distance

Code
1125-T101

Round shoulder points (optional)

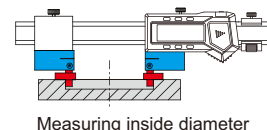
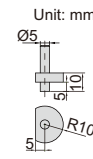

Measuring inside diameter

Code
1125-T102

Flat shoulder points (optional)

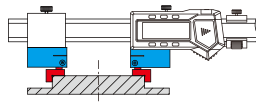
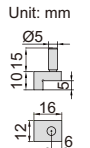

Measuring outside diameter

Code
1125-T103

Spherical points (included)

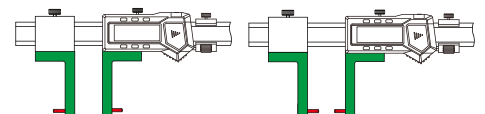
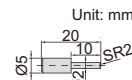

Point sleeve (optional)

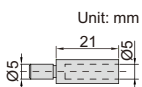

Code
1125-T104

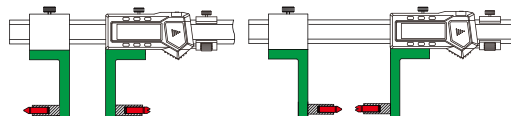

Working with multifunctional points, ball points and screw thread points

Stands (included)

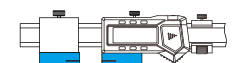
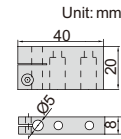

Measuring jaws (included)

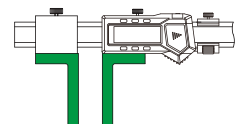
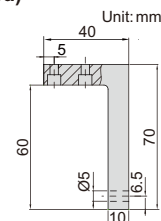

Multifunctional points 7392 (optional, next page)



Ball points 7391 (optional, next page)



Screw thread points 7381, 7321 (optional, next page)



DIGITAL CALIPER WITH INTERCHANGEABLE POINTS CODE 1526-200

DATA OUTPUT

short spherical points (included)

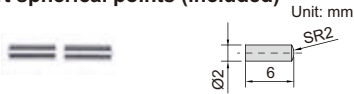

long spherical/flat points (included)



spherical blade points (included)

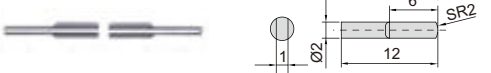

1526-200

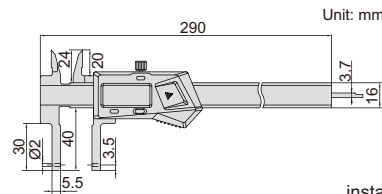

Unit: mm

measure internal and external grooves

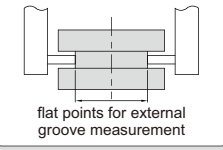
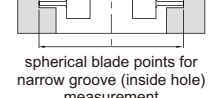
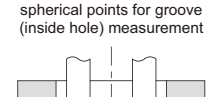
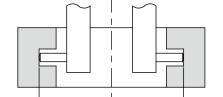

- Supplied with 3 pairs of points and zero setting block for external measurement
- Resolution: 0.01mm/0.0005"
- Buttons: on/off, set, mm/inch, preset (+, -)
- Automatic power off, move the digital unit to turn on power
- Battery CR2032
- Data output
- Made of stainless steel
- Optional accessory: points (code 1526-T101, 7392, 7391, 7381, 7321), depth stop (code 6143), data output cable (code 7306-20, 7302-SPC5A/SPC5B, 7305-SPC2A)

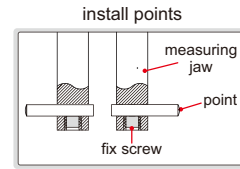
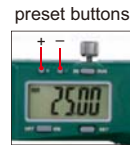

zero setting block for external measurement (included)



Point	Range	Accuracy	Application
short spherical points	12-212mm/0.5-8.5"(internal)	±0.03mm	for grooves inside small hole
long spherical/flat points	24-224mm/1-8.8"(internal) 0-187mm/0-7.5"(external)	±0.03mm	spherical points for grooves inside hole flat points for external grooves
spherical blade points	24-224mm/1-8.8"(internal) 0-187mm/0-7.5"(external)	±0.03mm	for narrow grooves inside hole

Depth stop (optional)



6143

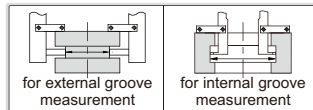
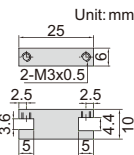

Code
6143

Multifunctional points (optional)

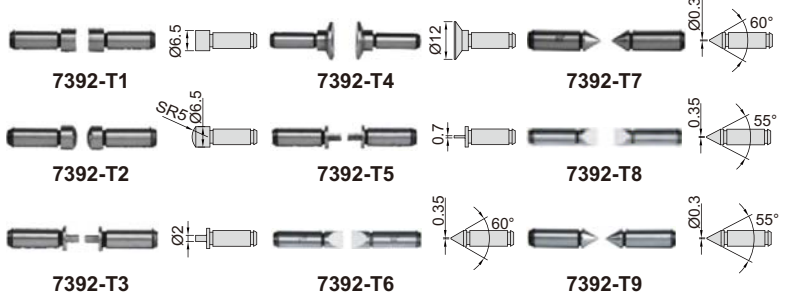

Code	Type	Code	Type	Code	Type
7392-T1*	flat	7392-T4*	disk	7392-T7*	point
7392-T2*	spherical	7392-T5*	blade	7392-T8*	knife-edge
7392-T3*	spline	7392-T6*	knife-edge	7392-T9*	point

* It is necessary to use point sleeve (code 1526-T101) for these points

Screw thread points (optional)

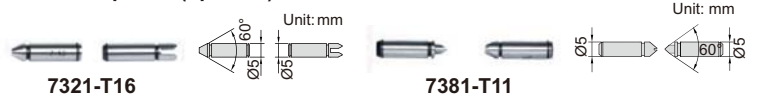

Point sleeve (optional)



1526-T101

Code
1526-T101

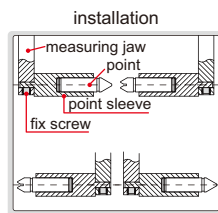
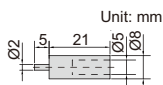

Ball points (optional)



7391-T5

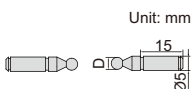

Unit: mm

Code	Ball dia.(D)	Module
7391-T3*	SØ2.0mm	1.25
7391-T4*	SØ2.5mm	1.5
7391-T5*	SØ3.0mm	1.75
7391-T6*	SØ3.5mm	2
7391-T7*	SØ4.0mm	2.25
7391-T8*	SØ4.5mm	2.5
7391-T9*	SØ5.0mm	2.75
7391-T10*	SØ6.0mm	3.5

* It is necessary to use point sleeve (code 1526-T101) for these points

Internal thread (60° thread angle)

Code	Pitch
7321-T11*	0.4-0.5mm/64-48TPI
7321-T12*	0.6-0.9mm/44-28TPI
7321-T13*	1-1.75mm/24-14TPI
7321-T14*	2-3mm/13-9TPI
7321-T15*	3.5-5mm/8-5TPI
7321-T16*	5.5-7mm/4.5-3.5TPI
7321-T1S*	6 pairs/set, including all above points

External thread (60° thread angle)

Code	Pitch
7381-T11*	0.4-0.5mm/64-48TPI
7381-T12*	0.6-0.9mm/44-28TPI
7381-T13*	1-1.75mm/24-14TPI
7381-T14*	2-3mm/13-9TPI
7381-T15*	3.5-5mm/8-5TPI
7381-T16*	5.5-7mm/4.5-3.5TPI
7381-TS*	6 pairs/set, including all above points

DIGITAL CALIPER WITH INTERCHANGEABLE POINTS CODE 1124-300A

DATA
OUTPUT



short spherical/flat points (included) Unit: mm

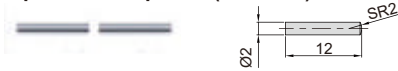

long spherical/flat points (included) Unit: mm



short spherical blade points (included) Unit: mm

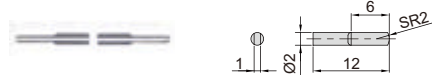

long spherical blade points (included) Unit: mm

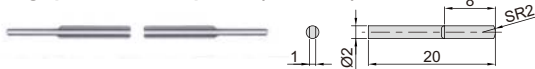

- Supplied with 4 pairs of points and zero setting block for external measurement
- Resolution: 0.01mm/0.0005"
- Buttons: on/off, set, mm/inch, preset (+, -)
- Automatic power off, move the digital unit to turn on power
- Battery CR2032
- Data output
- Made of stainless steel
- Optional accessory: points (code 1526-T101, 7392, 7391, 7381, 7321), depth stop (code 6143), data output cable (code 7306-20, 7302-SPC5A/SPC5B, 7305-SPC2A)



1124-300A

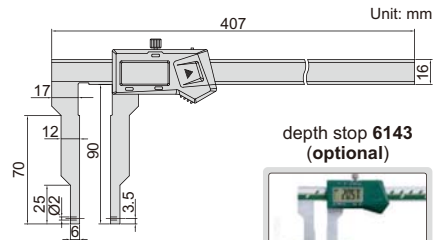

depth stop 6143
(optional)



install points

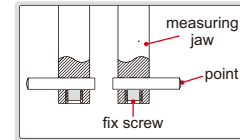

preset buttons

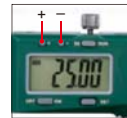

measure internal and
external grooves

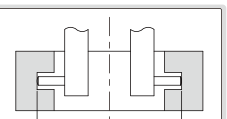

spherical points for groove
(inside hole) measurement

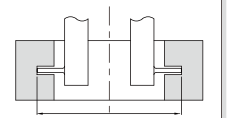

spherical blade points for
narrow groove (inside hole)
measurement

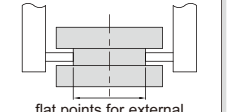

flat points for external
groove measurement

zero setting block for
external measurement
(included)



Point	Range	Accuracy	Application
short spherical/ flat points	24-324mm/1-12.7"(internal) 0-288mm/0-11.3"(external)	±0.04mm	spherical points for grooves inside hole (small hole) flat points for external grooves
long spherical/ flat points	40-340mm/1.5-13.3"(internal) 0-272mm/0-10.7"(external)	±0.04mm	spherical points for grooves inside hole (large hole) flat points for external grooves
short spherical blade points	24-324mm/1-12.7"(internal) 0-288mm/0-11.3"(external)	±0.04mm	for narrow grooves inside hole (small hole)
long spherical blade points	40-340mm/1.5-13.3"(internal) 0-272mm/0-10.7"(external)	±0.04mm	for narrow grooves inside hole (large hole)

Multifunctional points 7392
(optional, refer to 1526-200 for more details)



Ball points 7391
(optional, refer to 1526-200 for more details)



Screw thread points 7381, 7321
(optional, refer to 1526-200 for more details)



DIGITAL INSIDE GROOVE CALIPERS

DATA
OUTPUT



- Measure groove diameter
- Resolution: 0.01mm/0.0005"
- Buttons: on/off, set, mm/inch, preset (+, -)
- Automatic power off, move the digital unit to turn on power
- Battery CR2032
- Data output
- Made of stainless steel
- Optional accessory: depth stop (code 6143), data output cable (code 7306-20, 7302-SPC5A/SPC5B, 7305-SPC2A)

preset buttons

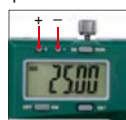

1120-150A

depth stop 6143
(optional)

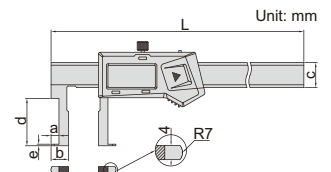
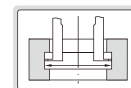

Code	Range	Accuracy	L	a	b	c	d	e
1120-150A	22-150mm	±0.04mm	250	5	11	16	30	1
1120-200A	25-200mm	±0.04mm	310	5	12.5	16	40	1
1120-300A	30-300mm	±0.05mm	410	5	15	17	50	1.5

DATA OUTPUT



DIGITAL INSIDE POINT CALIPERS

- Measure groove diameter
- Resolution: 0.01mm/0.0005"
- Buttons: on/off, set, mm/inch, preset (+, -)
- Automatic power off, move the digital unit to turn on power
- Battery CR2032
- Data output
- Made of stainless steel
- Optional accessory: depth stop (code 6143), data output cable (code 7306-20, 7302-SPC5A/SPC5B, 7305-SPC2A)

depth stop 6143 (optional)



1121-150A

Code	Range	Accuracy	L	a	b	c	d	D
1121-150A	24-150mm	±0.04mm	250	5	12	16	30	Ø2
1121-200A	25-200mm	±0.04mm	310	5	12.5	16	40	Ø2
1121-3001A	50-300mm	±0.06mm	410	8	25	17	80	Ø3

preset buttons

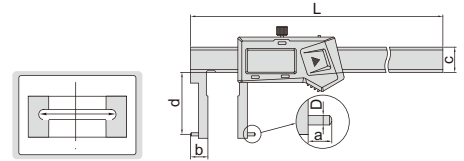
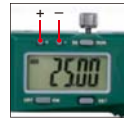

DATA OUTPUT

DIGITAL INSIDE GROOVE CALIPER

preset buttons

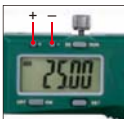

depth stop 6143 (optional)

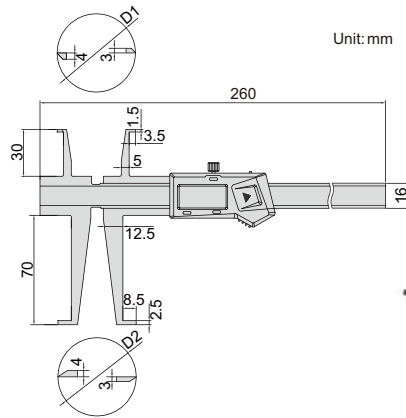

Unit: mm



1176-150

- Measure diameter of grooves inside bores
- Resolution: 0.01mm/0.0005"
- Buttons: on/off, set, mm/inch, preset (+, -)
- Automatic power off, move the digital unit to turn on power
- Battery CR2032
- Data output
- Made of stainless steel
- Optional accessory: depth stop (code 6143), data output cable (code 7306-20, 7302-SPC5A/SPC5B, 7305-SPC2A)

sizes to be measured (use upper jaws)

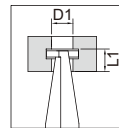

(mm)	
D1	L1
Ø9	<8
Ø10	<15
Ø11~150	<30

sizes to be measured (use lower jaws)

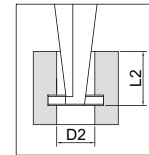

(mm)			
D2	L2	D2	L2
Ø15	<10	Ø19	<42
Ø16	<18	Ø20	<50
Ø17	<26	Ø21	<58
Ø18	<34	Ø22~150	<70

Code	Range of upper jaw	Range of lower jaw	Accuracy
1176-150	9-150mm/0.35-6"	15-150mm/0.59-6"	±0.04mm

DATA OUTPUT

DIGITAL INSIDE GROOVE CALIPER

- Measure diameter of grooves inside bores
- Resolution: 0.01mm/0.0005"
- Buttons: on/off, set, mm/inch, preset (+, -)
- Automatic power off, move the digital unit to turn on power
- Battery CR2032
- Data output
- Made of stainless steel
- Optional accessory: depth stop (code 6143), data output cable (code 7306-20, 7302-SPC5A/SPC5B, 7305-SPC2A)

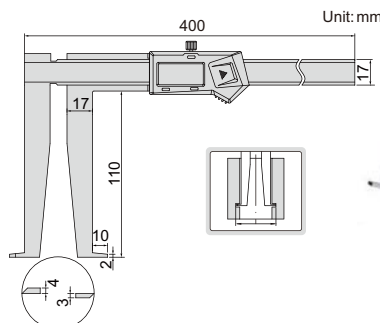

Unit: mm



1178-300

preset buttons

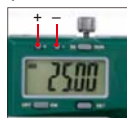

depth stop 6143 (optional)



sizes to be measured

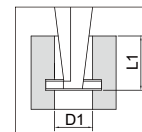

(mm)	
D1	L1
Ø25	<50
Ø26	<60
Ø27~300	<110

Code	Range	Accuracy
1178-300	25-300mm/1.18-12"	±0.05mm

DIGITAL INSIDE GROOVE CALIPER

- Measure diameter of grooves inside small bores
- Resolution: 0.01mm/0.0005"
- Buttons: on/off, set, mm/inch, preset (+, -)
- Automatic power off, move the digital unit to turn on power
- Battery CR2032
- Data output
- Made of stainless steel
- Optional accessory: depth stop (code **6143**), data output cable (code **7306-20**, **7302-SPC5A/SPC5B**, **7305-SPC2A**)



VIDEO

preset buttons



depth stop **6143** (optional)



1520-150

DATA OUTPUT

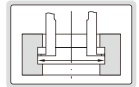
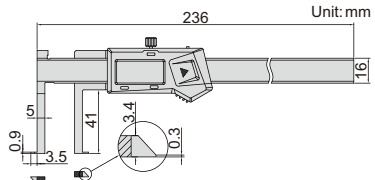

Code	Range	Accuracy
1520-150	11-150mm/0.43-6"	±0.04mm

DIGITAL OUTSIDE NECK CALIPER

- Measure grooves and recesses
- Resolution: 0.01mm/0.0005"
- Buttons: on/off, zero, mm/inch
- Automatic power off, move the digital unit to turn on power
- Battery CR2032
- Data output
- Made of stainless steel
- Optional accessory: depth stop (code **6143**), data output cable (code **7306-20**, **7302-SPC5A/SPC5B**, **7305-SPC2A**)

depth stop **6143** (optional)



1187-150A

DATA OUTPUT

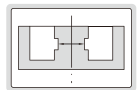
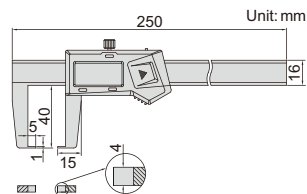

Code	Range	Accuracy
1187-150A	0-150mm/0-6"	±0.04mm

DIGITAL OUTSIDE POINT CALIPER

- Measure wall thickness inside bores and recesses
- Resolution: 0.01mm/0.0005"
- Buttons: on/off, zero, mm/inch
- Automatic power off, move the digital unit to turn on power
- Battery CR2032
- Data output
- Made of stainless steel
- Optional accessory: depth stop (code **6143**), data output cable (code **7306-20**, **7302-SPC5A/SPC5B**, **7305-SPC2A**)

depth stop **6143** (optional)



1185-150A

DATA OUTPUT

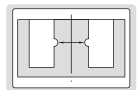
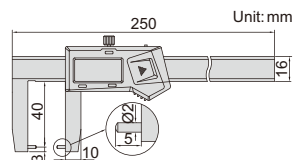

Code	Range	Accuracy
1185-150A	0-150mm/0-6"	±0.04mm

DEPTH STOP FOR CALIPERS

- Supplied in pair
- Made of stainless steel
- Suitable for caliper series **1124**, **1526**, **1520**, **1176**, **1178**, **1120**, **1121**, **1187** and **1185**

Code
6143

Application

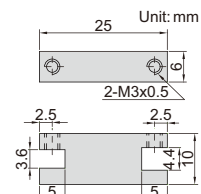
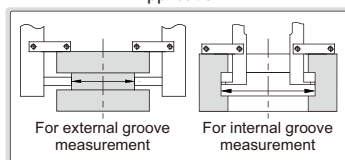

6143



VIDEO

DATA
OUTPUT

DIGITAL BLADE CALIPERS

- The blade jaws fit into small grooves
- Resolution: 0.01mm/0.0005"
- Buttons: on/off, zero, mm/inch
- Automatic power off, move the digital unit to turn on power
- Battery CR2032
- Data output
- Made of stainless steel
- Optional accessory: data output cable (code 7306-20, 7302-SPC5A/SPC5B, 7305-SPC2A)



1188-150A

Code	Range	Accuracy	L	a	b	c	d	e	g
1188-150A	0-150mm/0-6"	±0.03mm	235	21	16.5	16	40	0.75	17
1188-200A	0-200mm/0-8"	±0.03mm	297	24	20	16	50	0.75	17
1188-300A	0-300mm/0-12"	±0.04mm	390	26	21.5	16	60	1.00	17

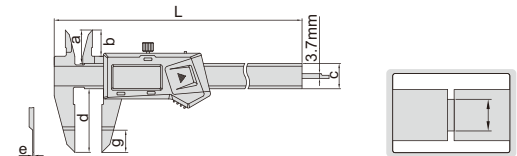

- Small pointed jaws fit into small grooves and recesses
- Resolution: 0.01mm/0.0005"
- Buttons: on/off, zero, mm/inch
- Automatic power off, move the digital unit to turn on power
- Battery CR2032
- Data output
- Made of stainless steel
- Optional accessory: data output cable (code 7306-20, 7302-SPC5A/SPC5B, 7305-SPC2A)

DATA
OUTPUT

DIGITAL SMALL POINT CALIPER



1169-150

Code	Range	Accuracy
1169-150	0-150mm/0-6"	±0.03mm

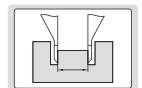
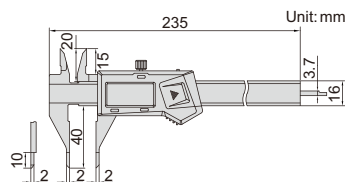

- Pointed jaws fit into small grooves and recesses
- Resolution: 0.01mm/0.0005"
- Buttons: on/off, zero, mm/inch
- Automatic power off, move the digital unit to turn on power
- Battery CR2032
- Data output
- Made of stainless steel
- Optional accessory: data output cable (code 7306-20, 7302-SPC5A/SPC5B, 7305-SPC2A)

DATA
OUTPUT

DIGITAL POINT CALIPER



1183-150A

Code	Range	Accuracy
1183-150A	0-150mm/0-6"	±0.03mm

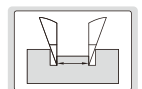
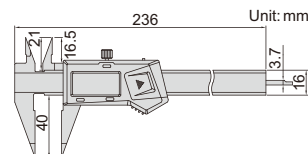

- Measure diameter of deep step holes
- Resolution: 0.01mm/0.0005"
- Buttons: on/off, zero, mm/inch
- Automatic power off, move the digital unit to turn on power
- Battery CR2032
- Data output
- Made of stainless steel
- Optional accessory: data output cable (code 7306-20, 7302-SPC5A/SPC5B, 7305-SPC2A)

DATA
OUTPUT

DIGITAL INSIDE KNIFE-EDGE CALIPER



1123-150A

Code	Range	Accuracy
1123-150A	15-150mm/0.6-6"	±0.05mm

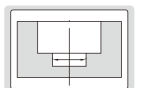
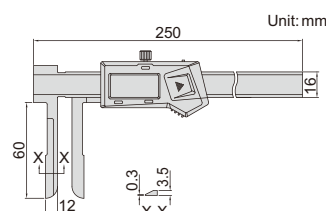

DIGITAL OFFSET CENTERLINE CALIPERS



VIDEO

DATA OUTPUT

- Measure hole center distance in the same or offset planes
- Resolution: 0.01mm/0.0005"
- Buttons: on/off, set, mm/inch, preset (+, -)
- Automatic power off, move the digital unit to turn on power
- Battery CR2032
- Data output
- Made of stainless steel
- Optional accessory: data output cable (code 7306-20, 7302-SPC5A/SPC5B, 7305-SPC2A)

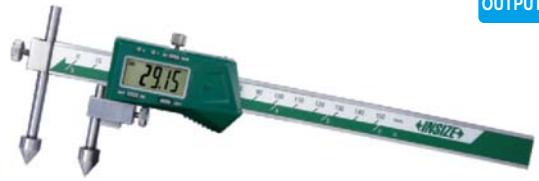

1192-150A

Code	Range	Accuracy	c	ØD	L1	L2	L
1192-150A	10-150mm/0.4-6"	±0.05mm	16	10	32	65	236
1192-200A	10-200mm/0.4-8"	±0.07mm	16	10	32	65	286
1192-300A	10-300mm/0.4-12"	±0.09mm	16	10	32	65	396
1192-500A	20-500mm/0.8-20"	±0.09mm	24	20	48	88	686
1192-1000A	30-1000mm/1.2-40"	±0.12mm	31	30	48	88	1242
1192-1500A	30-1500mm/1.2-60"	±0.15mm	31	30	48	88	1745

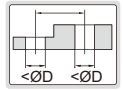
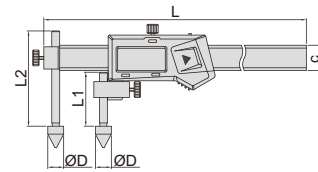

DIGITAL BACK-JAW CENTERLINE CALIPERS



VIDEO

DATA OUTPUT

- Measure hole center distance in the same or offset planes
- Resolution: 0.01mm/0.0005"
- Buttons: on/off, set, mm/inch, preset (+, -)
- Automatic power off, move the digital unit to turn on power
- Battery CR2032
- Data output
- Made of stainless steel
- Optional accessory: data output cable (code 7306-20, 7302-SPC5A/SPC5B, 7305-SPC2A)



back-jaw



1177-200

Code	Range	Accuracy	ØD	c	L1	L2	L
1177-200	10-200mm/0.4-8"	±0.10mm	10	16	18	45	310
1177-300	10-300mm/0.4-12"	±0.10mm	10	16	18	45	410
1177-500	20-500mm/0.8-20"	±0.10mm	20	24	26	70	692
1177-1000	30-1000mm/1.2-40"	±0.12mm	30	31	39	70	1242
1177-1500	30-1500mm/1.2-60"	±0.15mm	30	31	39	70	1745

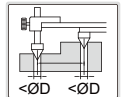
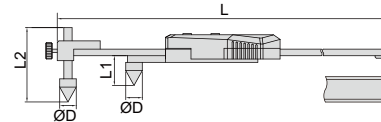

DIGITAL CENTERLINE/EDGE TO CENTER CALIPERS



VIDEO

DATA OUTPUT

- Measure hole center distance or edge to hole center distance
- Resolution: 0.01mm/0.0005"
- Buttons: on/off, set, mm/inch, preset (+, -)
- Automatic power off, move the digital unit to turn on power
- Battery CR2032
- Data output
- Made of stainless steel
- Optional accessory: data output cable (code 7306-20, 7302-SPC5A/SPC5B, 7305-SPC2A)



1525-300

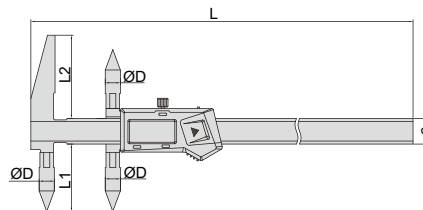

measure edge to hole center distance

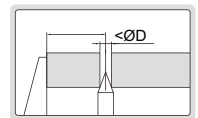

Code	Range of upper jaw (edge to center)	Range of lower jaw (center to center)	Accuracy	ØD	L1	L2	c	L
1525-300	5-300mm/0.2-12"	10-300mm/0.4-12"	±0.08mm	10	44.5	55	17	410
1525-500	10-500mm/0.4-20"	20-50mm/0.8-20"	±0.09mm	20	40	50	24	690
1525-1000	15-1000mm/0.6-40"	30-1000mm/1.2-40"	±0.12mm	30	60	70	31	1255
1525-1500	15-1500mm/0.6-60"	30-1500mm/1.2-60"	±0.15mm	30	60	70	31	1760

measure hole center distance

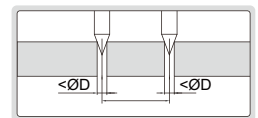



DIGITAL BACK-JAW EDGE TO CENTER CALIPERS

- Measure edge to hole center distance
- Resolution: 0.01mm/0.0005"
- Buttons: on/off, set, mm/inch, preset (+, -)
- Automatic power off, move the digital unit to turn on power
- Battery CR2032
- Data output
- Made of stainless steel
- Optional accessory: data output cable (code 7306-20, 7302-SPC5A/SPC5B, 7305-SPC2A)

preset buttons



back-jaw



DATA OUTPUT

1524-200

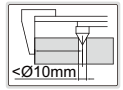
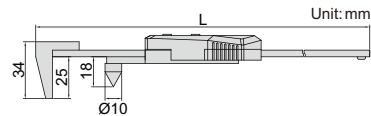

Code	Range	Accuracy	L (mm)
1524-200	5-200mm/0.2-8"	±0.1	310
1524-300	5-300mm/0.2-12"	±0.1	410

DIGITAL HOOK CALIPER

- Measure width of groove inside bores
- Resolution: 0.01mm/0.0005"
- Buttons: on/off, zero, mm/inch
- Automatic power off, move the digital unit to turn on power
- Battery CR2032
- Data output
- Made of stainless steel
- Optional accessory: data output cable (code 7306-20, 7302-SPC5A/SPC5B, 7305-SPC2A)

DATA OUTPUT



1122-200A

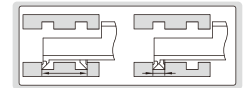
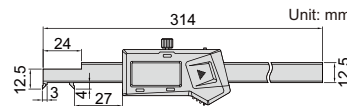

Code	Range	Accuracy
1122-200A	3-200mm/0.12-8"	±0.03mm

DIGITAL ARC RADIUS CALIPERS

DATA OUTPUT

- Measure the radius of arc less than half round
- Resolution: 0.01mm/0.0005"
- Buttons: on/off, zero, mm/inch
- Automatic power off, move the digital unit to turn on power
- Battery CR2032
- Data output
- Made of stainless steel
- Optional accessory: data output cable (code 7306-20, 7302-SPC5A/SPC5B, 7305-SPC2A)



1189-150B

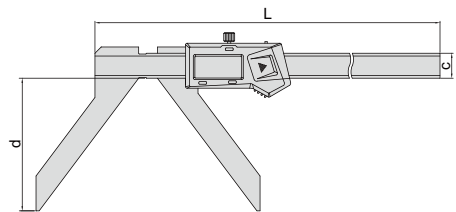
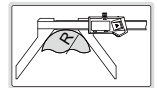

Code	Range (R)	Accuracy	L	c	d
1189-150B	5-150mm/0.2-6"	±0.05mm	263	16	65
1189-200B	5-200mm/0.2-8"	±0.07mm	313	16	85

DIGITAL OFFSET CALIPERS

DATA OUTPUT

- The left jaw can slide up and down to facilitate measurement of stepped sections
- Resolution: 0.01mm/0.0005"
- Buttons: on/off, zero, mm/inch
- Automatic power off, move the digital unit to turn on power
- Battery CR2032
- Data output
- Made of stainless steel
- Optional accessory: data output cable (code 7306-20, 7302-SPC5A/SPC5B, 7305-SPC2A)



1186-150A

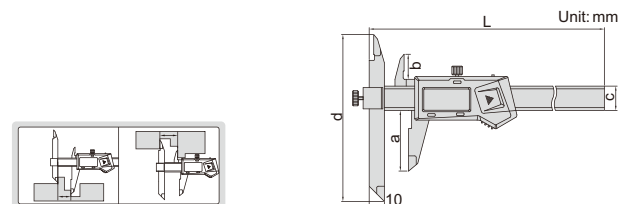

Code	Range	Accuracy	L	a	b	c	d
1186-150A	0-150mm/0-6"	±0.04mm	239	40	16.5	17	110
1186-200A	0-200mm/0-8"	±0.04mm	289	50	19.5	17	120
1186-300A	0-300mm/0-12"	±0.05mm	389	60	20.5	17	130

DIGITAL TUBE THICKNESS CALIPER

DATA
OUTPUT

- Measure wall thickness of tubes
- Resolution: 0.01mm/0.0005"
- Buttons: on/off, zero, mm/inch
- Automatic power off, move the digital unit to turn on power
- Battery CR2032
- Data output
- Made of stainless steel
- Optional accessory: data output cable (code 7306-20, 7302-SPC5A/SPC5B, 7305-SPC2A)



1161-150A

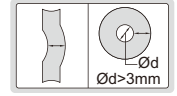
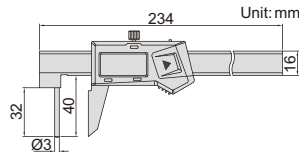

Code	Range	Accuracy
1161-150A	0-150mm/0-6"	±0.05mm

DIGITAL RTJ RING GROOVE CALIPERS

DATA
OUTPUT

- Measure ring grooves of flange
- Resolution: 0.01mm/0.0005"
- Button function: on/off, set, zero, mm/inch, data preset
- Battery CR2032
- Data output
- Made of stainless steel
- Optional accessory: data output cable (code 7306-20, 7302-SPC5A/SPC5B, 7305-SPC2A)



1179-300

1179-300
preset buttons

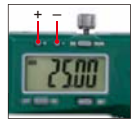

1179-600

measure outside diameter
of RTJ ring groove

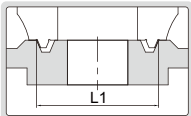

measure inside diameter
of RTJ ring groove

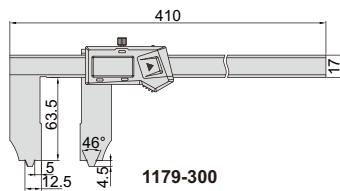
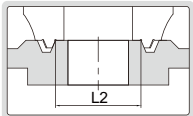

1179-300

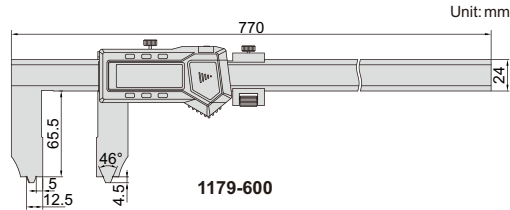

1179-600

applicable for RTJ ring
grooves with angle 23°

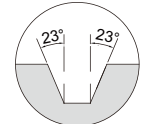

10mm and 25mm need to
be added on the reading

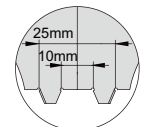

Code	Range (inside diameter of RTJ ring groove)	Range (outside diameter of RTJ ring groove)	Angle of RTJ ring groove	Accuracy
1179-300	10-300mm/0.4-12"	25-300mm/1-12"	23°	±0.06mm
1179-600	10-600mm/0.4-24"	25-600mm/1-24"	23°	±0.07mm

DIGITAL CRIMP HEIGHT CALIPER

RELATIVE PRODUCT: CRIMP HEIGHT
MICROMETER (CODE 3266-25BA, 3566-25BA)

DATA
OUTPUT

- Measure crimp height
- Resolution: 0.01mm/0.0005"
- Buttons: on/off, zero, mm/inch
- Automatic power off, move the digital unit to turn on power
- Battery CR2032
- Data output
- Meet DIN862
- Made of stainless steel
- Optional accessory: data output cable (code 7306-20, 7302-SPC5A/SPC5B, 7305-SPC2A)

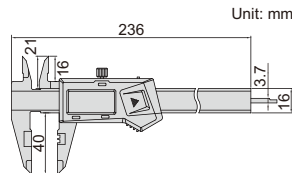

1165-150A

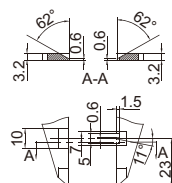

Code	Range	Accuracy
1165-150A	0-150mm/0-6"	±0.03mm

DATA OUTPUT

DIGITAL CALIPER WITH LARGE MEASURING FACES

- Measure diameter of wire ropes, and thickness of soft materials like rubber, sponge, etc.
- Resolution: 0.01mm/0.0005"
- Buttons: on/off, zero, mm/inch
- Automatic power off, move the digital unit to turn on power
- Battery CR2032
- Data output
- Made of stainless steel
- Optional accessory: data output cable (code 7306-20, 7302-SPC5A/SPC5B, 7305-SPC2A)

measure diameter of wire ropes

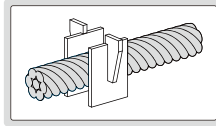

measure thickness of rubber, sponge, etc.

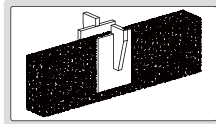

1172-200

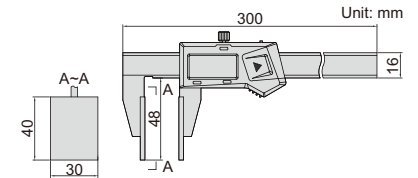

Code	Range	Accuracy
1172-200	0-200mm/0-8"	±0.07mm

DATA OUTPUT

DIGITAL GEAR TOOTH CALIPERS

- Resolution: 0.01mm/0.0005"
- Carbide tips
- Buttons: zero, on/off, mm/inch
- Battery LR44
- Data output
- Made of stainless steel
- Optional accessory: data output cable (code 7306-20, 7302-SPC1A/SPC1B, 7305-SPC2)

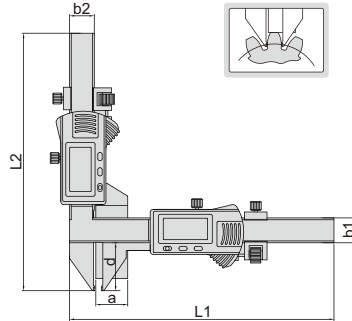

(mm)

Code	Range	Accuracy	L1	L2	a	b1	b2	d
1181-M25A	M1-25mm	±0.04mm	170	165.5	21	16	16	30.5
1181-M50A	M5-50mm	±0.04mm	220	190	50.5	16	16	55



1181-M25A

RELATIVE PRODUCT: DISK BRAKE MICROMETER (CODE 3288-, 3588-)

DATA OUTPUT

DIGITAL DISK BRAKE CALIPER

- Measure thickness of disk brakes
- Resolution 0.01mm/0.0005"
- Buttons: on/off, zero, mm/inch
- Automatic power off, move the digital unit to turn on power
- Battery CR2032
- Data output
- Made of stainless steel
- Optional accessory: data output cable (code 7306-20, 7302-SPC5A/SPC5B, 7305-SPC2A)



1162-125A

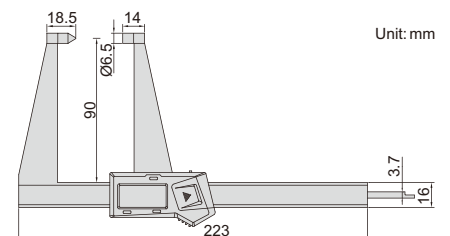

Code	Range	Accuracy
1162-125A	0-125mm/0-5"	±0.05mm

DIGITAL DISK BRAKE AND PAD CALIPER

RELATIVE PRODUCT: DISK BRAKE MICROMETER (CODE 3288-, 3588-)

DATA OUTPUT

- Measure thickness of disk brakes and pad wear
- Resolution: 0.01mm/0.0005"
- Buttons: on/off, zero, mm/inch
- Automatic power off, move the digital unit to turn on power
- Battery CR2032
- Data output
- Made of stainless steel
- Optional accessory: data output cable (code 7306-20, 7302-SPC5A/SPC5B, 7305-SPC2A)



1167-150A

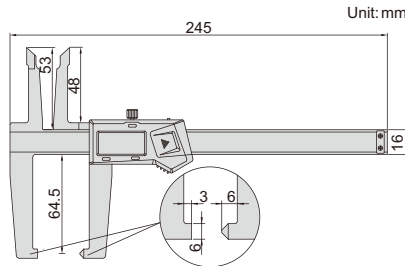

Code	Range	Accuracy
1167-150A	0-150mm/0-6"	±0.07mm

DIGITAL DRUM BRAKE CALIPER

RELATIVE PRODUCT: DISK BRAKE MICROMETER (CODE 3288-, 3588-)

DATA OUTPUT

- Measure internal and external diameter of drum brakes
- Resolution 0.01mm/0.0005"
- Buttons: on/off, zero, mm/inch
- Automatic power off, move the digital unit to turn on power
- Battery CR2032
- Data output
- Made of stainless steel
- Optional accessory: data output cable (code 7306-20, 7302-SPC5A/SPC5B, 7305-SPC2A)



1168-300A

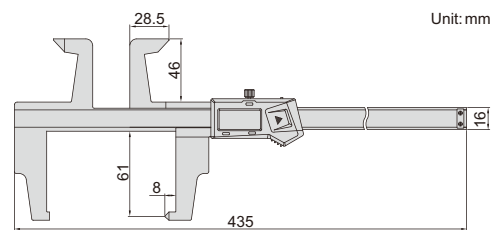
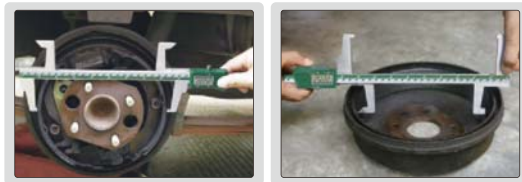

Code	Range	Accuracy
1168-300A	0-300mm/0-12"	±0.07mm

WATERPROOF DIGITAL DEPTH GAGES

ATTENTION: NO DATA OUTPUT

ATTENTION: IT IS NECESSARY TO SET ZERO AFTER POWER ON EACH TIME

IP67 WATERPROOF

- IP67 dust/waterproof
- Resolution: 0.01mm/0.0005"
- Button function: zero, on/off, mm/inch, ABS/REL, hold
- Meet DIN862
- Battery CR2032
- Made of stainless steel

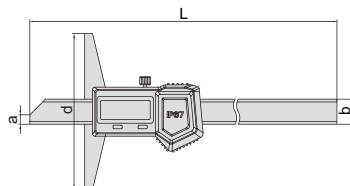

1149-150

Code	Range	Accuracy	L	a	b	d
1149-150	0-150mm/0-6"	±0.03mm	240	6	16	100
1149-200	0-200mm/0-8"	±0.03mm	290	6	16	100
1149-300	0-300mm/0-12"	±0.03mm	390	6	16	150

DIGITAL DEPTH GAGES (STANDARD MODEL)

- Resolution: 0.01mm/0.0005"
- Buttons: on/off, zero, mm/inch
- Automatic power off, move the digital unit to turn on power
- Meet DIN862 (except 1141-500A)
- Battery CR2032
- Data output
- Made of stainless steel
- Optional accessory: data output cable (code 7306-20, 7302-SPC5A/SPC5B, 7305-SPC2A)

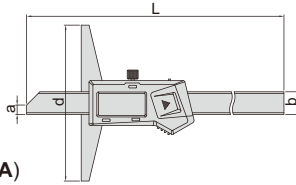

(mm)

Code	Range	Accuracy	L	a	b	d
1141-150A	0-150mm/0-6"	±0.03mm	230	6	14.5	100
1141-200A	0-200mm/0-8"	±0.03mm	280	6	14.5	100
1141-300A	0-300mm/0-12"	±0.03mm	380	6	14.5	150
1141-500A	0-500mm/0-20"	±0.05mm	585	7	15	150



DATA OUTPUT

1141-150A

DIGITAL DEPTH GAGES WITH MOUNTING HOLES FOR EXTENSION BASE

- Resolution: 0.01mm/0.0005"
- Buttons: on/off, zero, mm/inch
- Automatic power off, move the digital unit to turn on power
- Meet DIN862
- Battery CR2032
- Data output
- Made of stainless steel
- Optional accessory: data output cable (code 7306-20, 7302-SPC5A/SPC5B, 7305-SPC2A), extension base (code 6141)

DATA OUTPUT



1147-300

Unit: mm

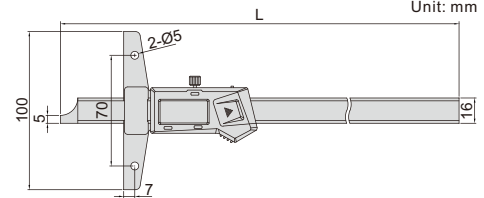

extension base (optional)



6141 series

Code	Range	Accuracy	L
1147-150	0-150mm/0-6"	±0.03mm	237
1147-200	0-200mm/0-8"	±0.03mm	287
1147-300	0-300mm/0-12"	±0.03mm	403

DIGITAL POINT DEPTH GAGE

- Resolution: 0.01mm/0.0005"
- Buttons: on/off, zero, mm/inch
- Automatic power off, move the digital unit to turn on power
- Meet DIN862
- Battery CR2032
- Data output
- Made of stainless steel
- Optional accessory: data output cable (code 7306-20, 7302-SPC5A/SPC5B, 7305-SPC2A)

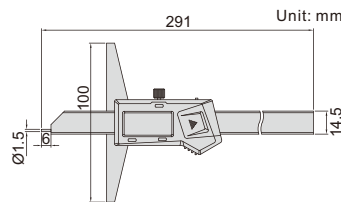

Unit: mm



1143-200A

DATA OUTPUT

Code	Range	Accuracy
1143-200A	0-200mm/0-8"	±0.03mm

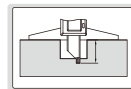

DIGITAL HOOK DEPTH GAGES

- Resolution: 0.01mm/0.0005"
- Buttons: on/off, zero, mm/inch
- Automatic power off, move the digital unit to turn on power
- Battery CR2032
- Data output
- Made of stainless steel
- Optional accessory: data output cable (code 7306-20, 7302-SPC5A/SPC5B, 7305-SPC2A)

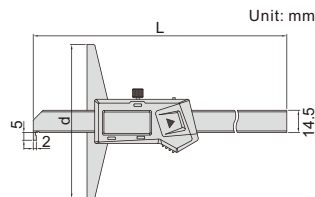

Unit: mm



1142-150A

DATA OUTPUT

Code	Range	Accuracy	L	d
1142-150A	0-150mm/0-6"	±0.03mm	230	100
1142-200A	0-200mm/0-8"	±0.03mm	280	100
1142-300A	0-300mm/0-12"	±0.04mm	380	150

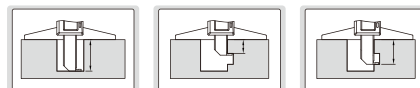

DIGITAL DOUBLE HOOK DEPTH GAGES

DATA
OUTPUT

- Resolution: 0.01mm/0.0005"
- Buttons: on/off, zero, mm/inch
- Automatic power off, move the digital unit to turn on power
- Meet DIN862
- Battery CR2032
- Data output
- Made of stainless steel
- Optional accessory: data output cable
(code 7306-20, 7302-SPC5A/SPC5B, 7305-SPC2A)



1144-150A

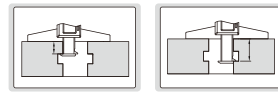
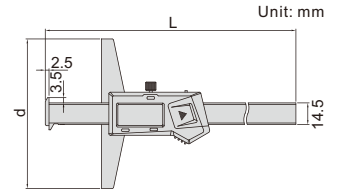

Code	Range	Accuracy	L	d
1144-150A	0-150mm/0-6"	±0.03mm	233	100
1144-200A	0-200mm/0-8"	±0.03mm	283	100
1144-300A	0-300mm/0-12"	±0.03mm	383	150

DIGITAL DEPTH GAGES WITH ROUND DEPTH BAR

MEASURE WIDTH AND DEPTH
OF GROOVES INSIDE BORE

MEASURE DEPTH OF
SMALL HOLES (>Ø4mm)

DATA
OUTPUT



preset buttons

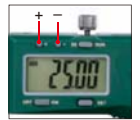

- Resolution: 0.01mm/0.0005"
- Supplied with three interchangeable points (flat, spherical, disk)
- Buttons: on/off, set, mm/inch, preset (+, -)
- Automatic power off, move the digital unit to turn on power
- Battery CR2032
- Data output
- Made of stainless steel
- Optional accessory: data output cable
(code 7306-20, 7302-SPC5A/SPC5B, 7305-SPC2A),
disk points (see below table),
extension base (code 6141, for 1148-120 and 1148-200)



1148-100S

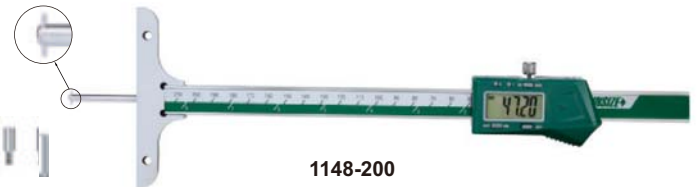

1148-200



1148-120

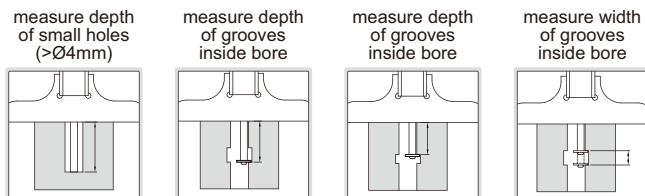
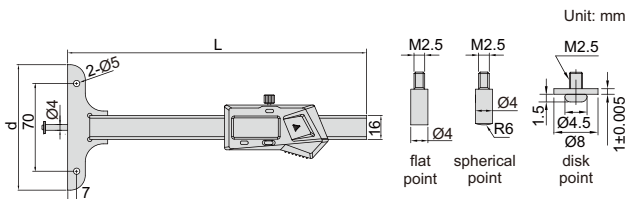

one-hand use of 1148-120



extension base for 1148-120
and 1148-200 (optional)



(mm)

Code	Range*	Accuracy	L	d	Remark
1148-100S	0-100mm/0-4"	±0.02mm	200	45	
1148-100	0-100mm/0-4"	±0.02mm	200	85	
1148-120	0-120mm/0-4.7"	±0.03mm	300	101	one-hand use, with mounting holes for extension base
1148-200	0-200mm/0-8"	±0.03mm	300	101	with mounting holes for extension base

* When disk points are used, the range is reduced by 10mm

OPTIONAL DISK POINTS

Code	Description	H	Remark
1148-P101	0.5mm disk point	0.5±0.005mm	for narrow grooves
1148-P102	0.7mm disk point	0.7±0.005mm	for narrow grooves
1148-P103	1mm disk point	1±0.005mm	for grooves inside blind hole
1148-P104	0.5mm disk point	0.5±0.005mm	for grooves inside blind hole

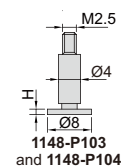
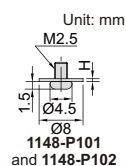

1148-P101
(optional)



1148-P103 (optional), measure width
of bottom grooves inside blind hole

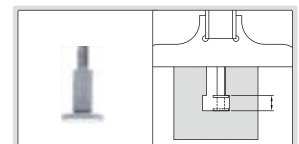

VERNIER DEPTH GAGES (STANDARD MODEL)

- Made of stainless steel
- Satin chrome plated reading surface

Graduation 0.05mm (mm)

Code	Range	Accuracy	L	d
1240-150	0-150mm	±0.05mm	245	100
1240-200	0-200mm	±0.05mm	282	100
1240-300	0-300mm	±0.08mm	382	100
1240-500	0-500mm	±0.09mm	585	150

Graduation 0.02mm (mm)

Code	Range	Accuracy	L	d
1240-1501	0-150mm	±0.03mm	245	100
1240-2001	0-200mm	±0.03mm	282	100
1240-3001	0-300mm	±0.04mm	382	100
1240-5001	0-500mm	±0.05mm	585	150



1240-2001

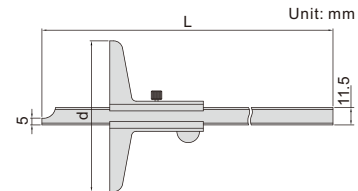

WITH MOUNTING HOLES FOR EXTENSION BASE

- Made of stainless steel
- Satin chrome plating finish on reading surface
- Optional accessory: extension base (code 6141)

extension base (optional)

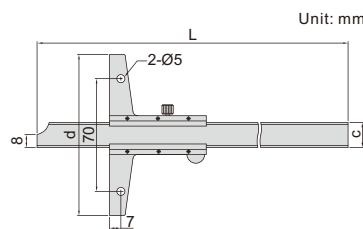

VERNIER DEPTH GAGES



1247-1501

Graduation 0.05mm

Code	Range	Accuracy
1247-150	0-150mm	±0.05mm
1247-200	0-200mm	±0.05mm
1247-300	0-300mm	±0.08mm
1247-600	0-600mm	±0.10mm
1247-1000	0-1000mm	±0.15mm

Graduation 0.02mm

Code	Range	Accuracy
1247-1501	0-150mm	±0.03mm
1247-2001	0-200mm	±0.03mm
1247-3001	0-300mm	±0.04mm
1247-6001	0-600mm	±0.05mm
1247-1001	0-1000mm	±0.07mm

	(mm)			
Range	L	c	d	
0-150mm	240	16	100	
0-200mm	290	16	100	
0-300mm	390	16	100	
0-600mm	704	16	150	
0-1000mm	1124	18	200	

WITH MOUNTING HOLES FOR EXTENSION BASE

- With fine adjustment
- Made of stainless steel
- Satin chrome plating finish on reading surface
- Optional accessory: extension base (code 6141)

extension base (optional)

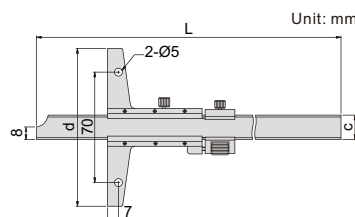

VERNIER DEPTH GAGES WITH FINE ADJUSTMENT



1249-1501

Graduation 0.05mm

Code	Range	Accuracy
1249-150	0-150mm	±0.05mm
1249-200	0-200mm	±0.05mm
1249-300	0-300mm	±0.08mm

Graduation 0.02mm

Code	Range	Accuracy
1249-1501	0-150mm	±0.03mm
1249-2001	0-200mm	±0.03mm
1249-3001	0-300mm	±0.04mm

	(mm)			
Range	L	c	d	
0-150mm	256	16	100	
0-200mm	306	16	100	
0-300mm	406	16	100	

VERNIER HOOK DEPTH GAGES

WITH MOUNTING HOLES FOR EXTENSION BASE

- Made of stainless steel
- Satin chrome plating finish on reading surface
- Optional accessory: extension base (code 6141)



1248-1501

extension base (optional)

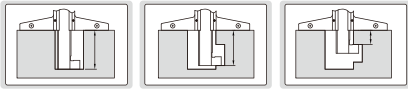

Graduation 0.05mm

Code	Range	Accuracy	L
1248-150	0-150mm	±0.05mm	266mm
1248-200	0-200mm	±0.05mm	316mm
1248-300	0-300mm	±0.08mm	416mm

Graduation 0.02mm

Code	Range	Accuracy	L
1248-1501	0-150mm	±0.03mm	266mm
1248-2001	0-200mm	±0.03mm	316mm
1248-3001	0-300mm	±0.04mm	416mm

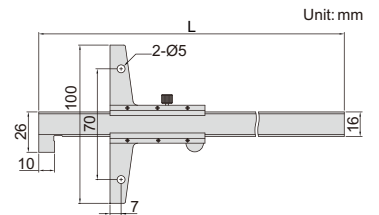

EXTENSION BASES



6141-260

- Supplied with two screws
- Made of stainless steel
- Suitable for depth gages series 1147, 1148, 1247, 1248 and 1249

Code	Length
6141-180	180mm
6141-260	260mm
6141-320	320mm

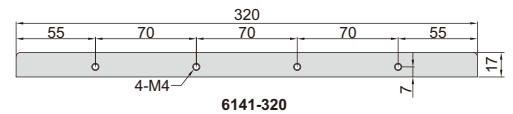
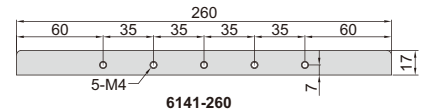
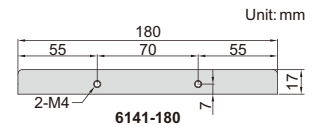
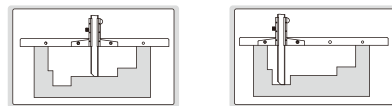

VERNIER DEPTH GAGE

ATTENTION: BASIC MODEL

- Graduation: 0.1mm
- Made of stainless steel



1244-30

Code	Range	Accuracy
1244-30	0-30mm	±0.10mm

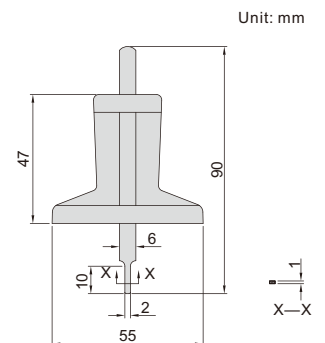

DATA OUTPUT

- Measure depth of small groove and hole, also measure depth of tire tread
- Resolution: 0.01mm/0.0005"
- Buttons: on/off, zero, mm/inch
- Supplied with zero set surface (included)
- Automatic power off, move the digital unit to turn on power
- Battery CR2032
- Data output
- Made of stainless steel
- Optional accessory: data output cable (code 7306-20, 7302-SPC5A/SPC5B, 7305-SPC2A)

Code	Range	Accuracy
1145-25A	0-25mm/0-1"	±0.03mm



1145-25A

DIGITAL DEPTH GAGE

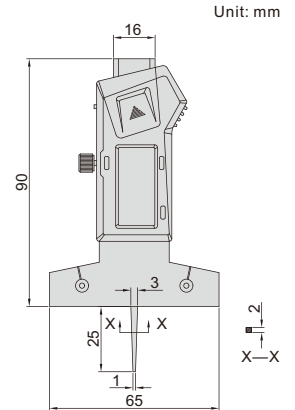

DIAL DEPTH GAGES

- Accuracy: ±0.017mm
- Stainless steel base
- Pointed tip

Code	Range	Dial indicator stroke	Dial indicator graduation	Base
2343-101	0-10mm	10mm	0.01mm	Ø16mm
2343-102	0-10mm	10mm	0.01mm	Ø25mm



2343-102

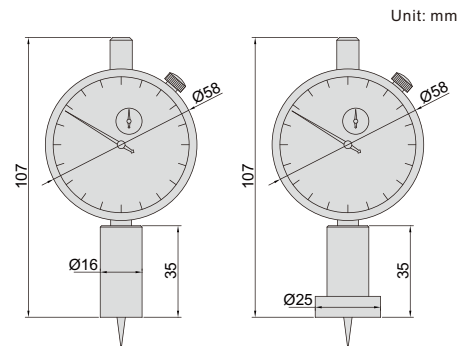

2343-101

2343-102

DATA OUTPUT

- Accuracy: ±0.02mm
- Button function: on/off, zero, mm/inch, ABS, data preset, change measuring direction
- CR2032 battery, automatic power off
- Data output
- Stainless steel base
- Pointed tip
- Optional accessory: data output cable (code 7306-40, 7302-SPC3A, 7305-SPC1A)

Code	Range	Digital indicator stroke	Digital indicator resolution	Base
2142-101	0-12.7mm/0-0.5"	12.7mm/0.5"	0.01mm/0.0005"	Ø16mm
2142-102	0-12.7mm/0-0.5"	12.7mm/0.5"	0.01mm/0.0005"	Ø25mm



2142-102

DIGITAL DEPTH GAGES

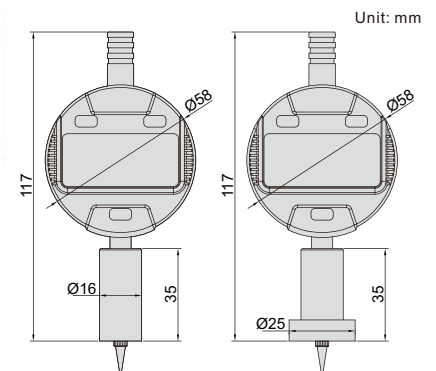

2142-101

2142-102

DIAL DEPTH GAGES



2342-202

- Dial indicator graduation: 0.01mm
- Accuracy: ± 0.03 mm
- Stainless steel base
- Extension rods: 25mm (1pc), 50mm (1pc), 75mm (1pc), 100mm (2pcs)
- Supplied with pointed tip and ball tip

Code	Range	Dial indicator stroke	Base
2342-201	0-300mm	30mm	63x17mm
2342-202	0-300mm	30mm	101.5x17mm

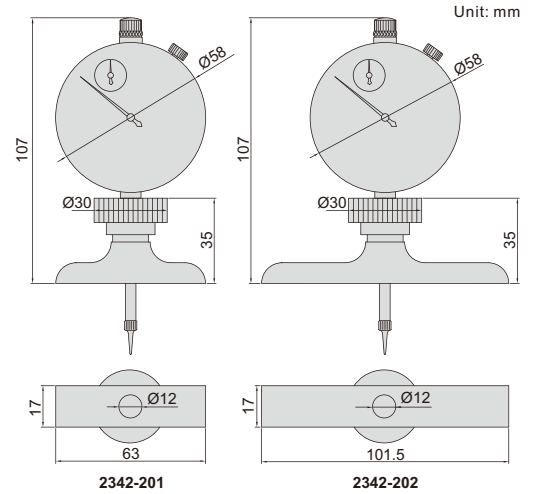

Unit: mm

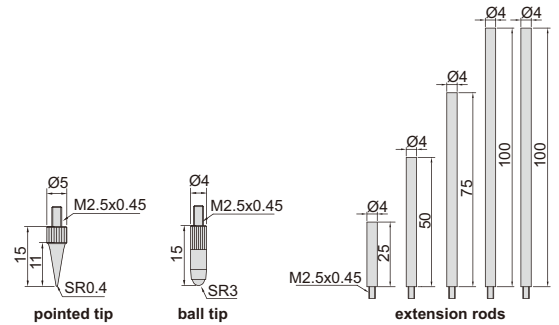

DIGITAL DEPTH GAGES



2141-202A

- Button function: on/off, zero, mm/inch, ABS, data preset, change measuring direction
- CR2032 battery, automatic power off
- Data output
- Stainless steel base
- Extension rods: 12.5mm (1pc), 25mm (1pc), 50mm (1pc), 75mm (1pc), 100mm (2pcs)
- Supplied with pointed tip and ball tip
- Optional accessory: data output cable (code 7306-40, 7302-SPC3A, 7305-SPC1A)

Code	Range	Digital indicator stroke	Digital indicator resolution	Accuracy	Base
2141-201A	0-300mm/0-12"	12.7mm/0.5"	0.01mm/0.0005"	± 0.02 mm	63x17mm
2141-202A	0-300mm/0-12"	12.7mm/0.5"	0.01mm/0.0005"	± 0.02 mm	101.5x17mm



DATA OUTPUT

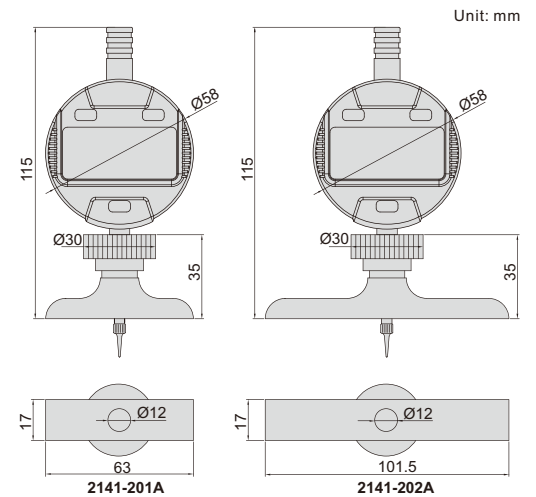

Unit: mm

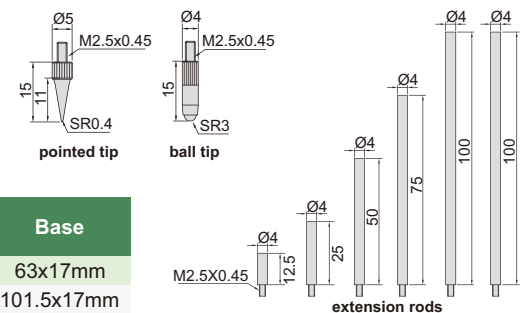

DIAL DEPTH GAGE

- Accuracy: $\pm 0.017\text{mm}$
- Stainless steel base
- Supplied with pointed tip and ball tip

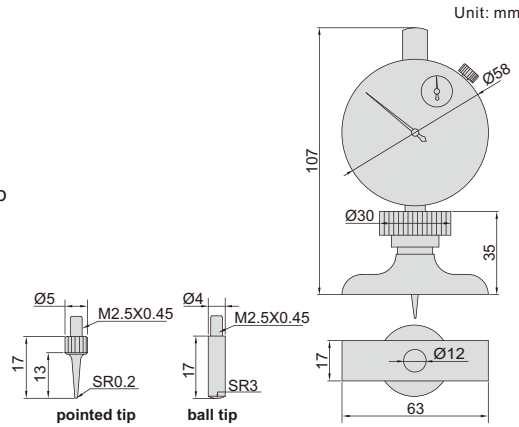

2341-101A

Code	Range	Dial indicator stroke	Dial indicator graduation
2341-101A	0-10mm	10mm	0.01mm

IP54
WATERPROOF

DATA
OUTPUT

DIGITAL DEPTH MICROMETERS

- Resolution: 0.001mm/0.00005"
- Micrometer head accuracy: $\pm 3\mu\text{m}$
- Rod accuracy: $\pm (2+L/75)\mu\text{m}$, L is the measuring range in mm
- Button function: on/off, set, mm/inch, ABS/INC, data output
- IP54 dust/waterproof
- Data output
- LR44 battery, automatic power off
- Rods with flat end
- Ratchet stop
- Optional accessory: data output cable (code 7306-30, 7302-SPC2A, 7305-SPC3)

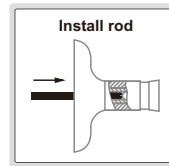

3540-50

Code	Range	Rods
3540-50	0-50mm/0-2"	2pcs
3540-150	0-150mm/0-6"	6pcs
3540-300	0-300mm/0-12"	12pcs

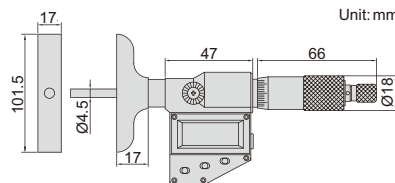

DEPTH MICROMETERS

- Meet DIN863-2
- Graduation: 0.01mm
- Micrometer head accuracy: $\pm 3\mu\text{m}$
- Rod accuracy: $\pm (2+L/75)\mu\text{m}$, L is the measuring range in mm
- Rods with flat end
- Ratchet stop

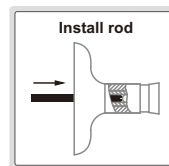

3240-100

Code	Range	Rods
3240-25	0-25mm	1pc
3240-50	0-50mm	2pcs
3240-75	0-75mm	3pcs
3240-100	0-100mm	4pcs
3240-150	0-150mm	6pcs
3240-200	0-200mm	8pcs
3240-300	0-300mm	12pcs

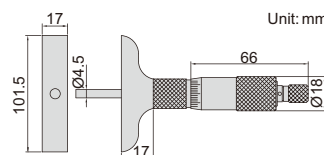

DEPTH MICROMETERS

- Meet DIN863-2
- Graduation: 0.01mm
- Micrometer head accuracy: $\pm 3\mu\text{m}$
- Rod accuracy: $\pm (2+L/75)\mu\text{m}$, L is the measuring range in mm
- Rods with flat end
- Ratchet stop



3241-100

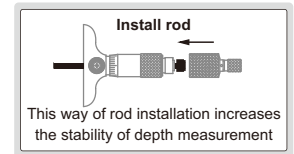

Base: HxW=101.5x17mm

Code	Range	Rods
3241-25	0-25mm	1pc
3241-50	0-50mm	2pcs
3241-75	0-75mm	3pcs
3241-100	0-100mm	4pcs
3241-150	0-150mm	6pcs
3241-200	0-200mm	8pcs
3241-300	0-300mm	12pcs

Base: HxW=63x17mm

Code	Range	Rods
3241-B25	0-25mm	1pc

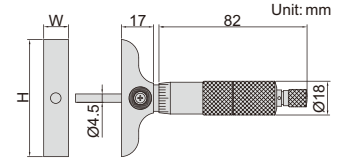

DIGITAL HEIGHT GAGES (ECONOMIC MODEL)

ATTENTION:
LOW ACCURACY

ATTENTION: CAN NOT USE CLAMP
FOR PROTRACTORS (CODE 2372-CLAMP)

DATA
OUTPUT

- Resolution: 0.01mm/0.0005"
- Buttons: on/off, zero, mm/inch, ABS/INC, data hold, TOL, set
- ABS/INC is for absolute and incremental measurement
- TOL is for tolerance measurement
- Carbide tipped scriber
- Made of stainless steel (except the base)
- LR44 battery
- Data output
- Supplied with dial test indicator holder
- Supplied with dust cover (except 1150-1500/2000)
- Optional accessory: data output cable (code 7301-SPC5)

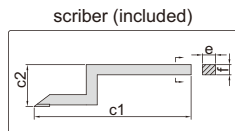

data output cable (optional)



dial test indicator
holder (included)

Unit: mm

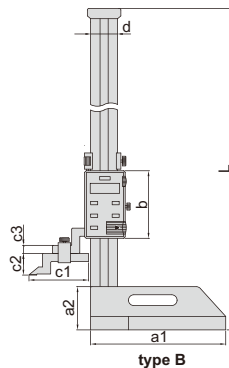
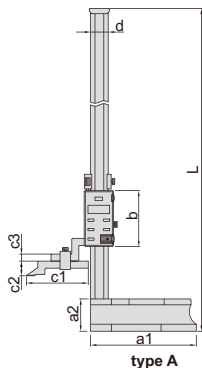
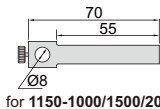
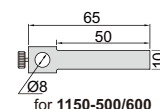
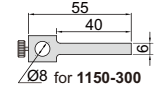

1150-1000



1150-500

dust cover
(included, except
1150-1500/2000)



Code	Range	Type	Accuracy	L	a1	a2	b	c1	c2	c3	d	e	f
1150-300	0-300mm/0-12"	A	$\pm 0.05\text{mm}$	470	135	45	80	76	25	10	23	6	8
1150-500	0-500mm/0-20"	A	$\pm 0.06\text{mm}$	720	180	55	95	103	25	12	30	10	12
1150-600	0-600mm/0-24"	A	$\pm 0.06\text{mm}$	820	180	55	95	103	25	12	30	10	12
1150-1000	0-1000mm/0-40"	B	$\pm 0.08\text{mm}$	1275	250	80	125	110	39	15	50	10	15
1150-1500	0-1500mm/0-60"	B	$\pm 0.12\text{mm}$	1790	280	80	125	110	39	15	50	10	15
1150-2000	0-2000mm/0-80"	B	$\pm 0.16\text{mm}$	2290	280	80	125	110	39	15	50	10	15

DATA OUTPUT

METAL RACK



VIDEO

DIGITAL HEIGHT GAGES WITH DRIVING WHEEL

- Resolution: 0.01mm/0.0005"
- Buttons: on/off, zero, mm/inch, preset +, preset -, hold
- Automatic power off, move the digital unit to turn on power
- Carbide tipped scriber
- Made of stainless steel
- Battery CR2032
- Data output
- Supplied with dust cover
- Optional accessory: data output cable (code **7306-20**, **7302-SPC5A/SPC5B**, **7305-SPC2A**), dial test indicator holder (code **6293-6**), clamp for protractors (code **2372-CLAMP**)

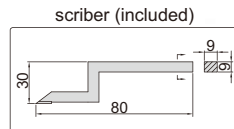
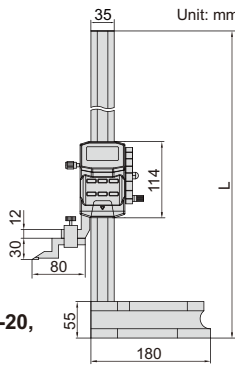

1156-300

dial test indicator holder (optional)

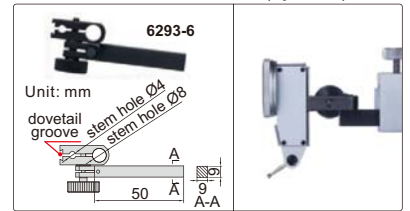

clamp for protractors (optional)

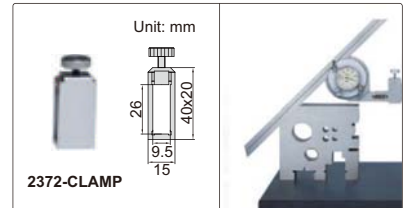

Code	Range	Accuracy	L
1156-300	0-300mm/0-12"	±0.03mm	515mm
1156-600	0-600mm/0-24"	±0.05mm	815mm

DATA OUTPUT

ATTENTION: CAN NOT USE CLAMP FOR PROTRACTORS (CODE 2372-CLAMP)

DIGITAL HEIGHT GAGE (LIGHT DUTY)

- Resolution: 0.01mm/0.0005"
- Buttons: on/off, zero, mm/inch
- Automatic power off, move the digital unit to turn on power
- Carbide tipped scriber
- With fine adjustment
- Made of stainless steel
- Battery CR2032
- Data output
- Optional accessory: data output cable (code **7306-20**, **7302-SPC5A/SPC5B**, **7305-SPC2A**), dial test indicator holder (code **7151-CL1**)

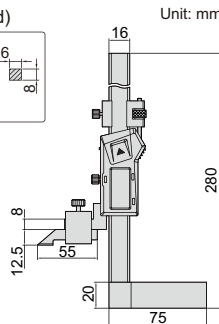
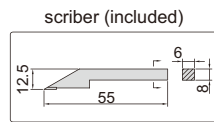

dial test indicator holder (optional)

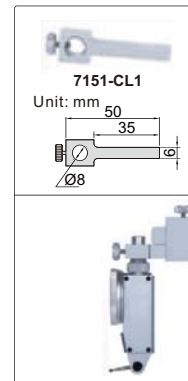

1154-150

Code	Range	Accuracy
1154-150	0-150mm/0-6"	±0.03mm



VIDEO



driving wheel

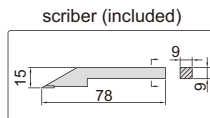

dust cover (included)

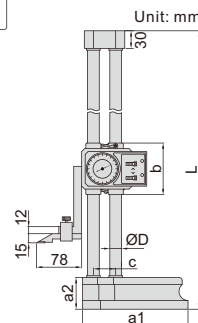

(mm)

Code	Range	Accuracy	L	a1	a2	b	c	ØD
1351-300	0-300mm	±0.04mm	475	135	43	84	33	15
1351-450	0-450mm	±0.05mm	660	180	54	88	38	20
1351-600	0-600mm	±0.05mm	810	180	54	88	38	20



1351-300

DIAL HEIGHT GAGES

dial test indicator holder (optional)

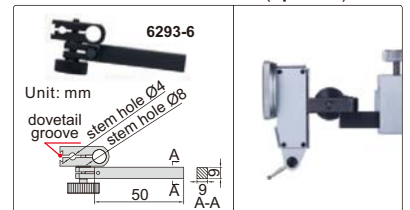

clamp for protractors (optional)

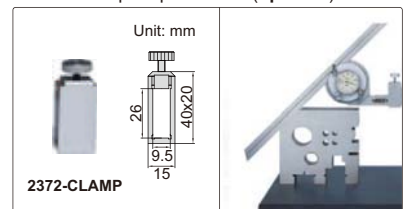

VERNIER HEIGHT GAGES

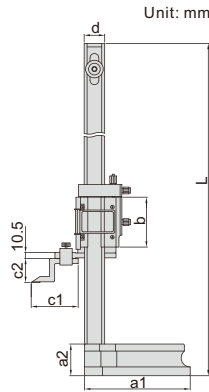
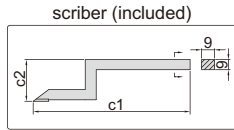

- Graduation: 0.02mm/0.001"
- Adjustable main scale to set zero
- Carbide tipped scribe
- Made of stainless steel (except the base)
- Satin chrome plated scale
- Supplied with magnifier
- With fine adjustment
- Supplied with dust cover
- Optional accessory: dial test indicator holder (code **6293-6**), clamp for protractors (code **2372-CLAMP**)

Code	Range	Accuracy	L	a1	a2	b	c1	c2	d
1250-300	0-300mm/0-12"	±0.04mm	545	135	43	75	80	30	28
1250-450	0-450mm/0-18"	±0.05mm	720	180	54	85	80	41	35
1250-600	0-600mm/0-24"	±0.05mm	870	180	54	85	80	41	35

dial test indicator holder (optional)

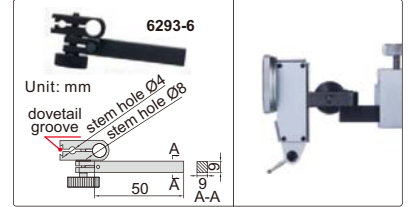

clamp for protractors (optional)

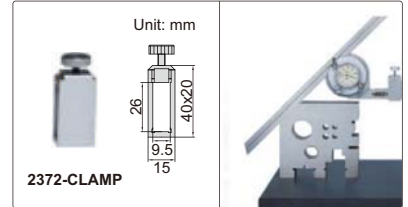

VERNIER HEIGHT GAGES (LIGHT DUTY)

ATTENTION: CAN NOT USE CLAMP FOR PROTRACTORS (CODE 2372-CLAMP)

- Graduation 0.02mm/0.001"
- Carbide tipped scribe
- Made of stainless steel (except the base)
- Satin chrome plated scale
- Optional accessory: dial test indicator holder (code **7151-CL1**)

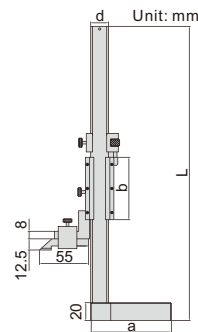
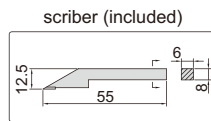

dial test indicator holder (optional)

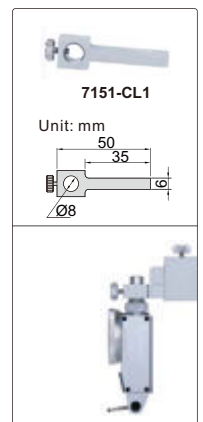

Code	Range	Accuracy	L	a	b	d
1253-150	0-150mm/0-6"	±0.03mm	265	75	57	16
1253-200	0-200mm/0-8"	±0.03mm	325	90	70	20

MINI DIGITAL HEIGHT GAGES

DATA OUTPUT

application of 1146-20A

application of 1146-20B

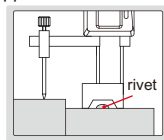
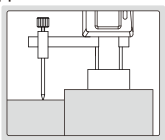

- Measure height difference of two surfaces (1146-20B suitable for surfaces with barrier, such as rivet)
- Resolution: 0.01mm/0.0005"
- Buttons: on/off, zero, mm/inch
- Automatic power off, move the digital unit to turn on power
- Battery CR2032
- Data output
- Made of stainless steel
- Optional accessory: data output cable (code **7306-20**, **7302-SPC5A/SPC5B**, **7305-SPC2A**)

Code	Range	Accuracy
1146-20A	0~±20mm/0~±0.8"	±0.02mm
1146-20B	0~±20mm/0~±0.8"	±0.02mm

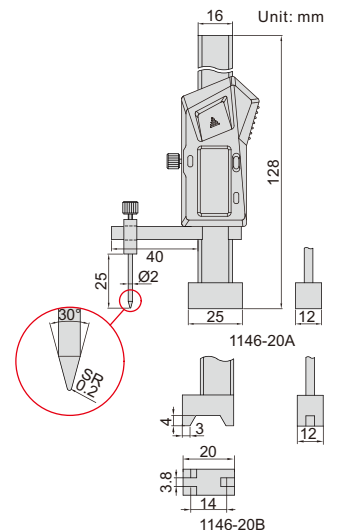

1146-20A

1146-20B

1146-20B

SCRIBERS FOR HEIGHT GAGES

- Carbide tipped



7150-SC1

(mm)

Code	For height gages	Type	c1	c2	D	E
7150-SC1	1150-300	A	76	25	6	8
7150-SC2	1150-500, 1150-600	A	103	25	10	12
7150-SC3	1150-1000, 1150-1500, 1150-2000	A	110	39	10	15
7150-SC4	1351-300, 1351-450, 1351-600	B	78	15	9	9
7150-SC6	1250-300, 1156-300, 1156-600	A	80	30	9	9
7150-SC7	1250-450, 1250-600	A	80	41	9	9
7150-SC9	1253-150, 1253-200, 1154-150	B	55	12.5	6	8

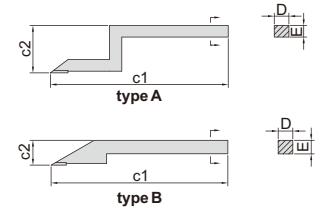

NON-ROTATING SPINDLE

DATA OUTPUT

NON-ROTATING SPINDLE DIGITAL MICROMETERS

- Resolution: 0.001mm/0.00005"
- Repeatability: 1µm
- Measuring force: 5-10N
- Non-rotating spindle, suitable for cylinders
- Quick measurement: one turn of sleeve or ratchet stop makes 1mm spindle feed
- Carbide measuring faces
- Ratchet stop
- Data output
- Button function: mm/inch, max./min. value tracking, tolerance measurement, hold, on/off, zero
- CR2032 battery, automatic power off
- Supplied with setting standards (except 0-25mm/0-1")



QUICK MEASUREMENT
ONE TURN OF SLEEVE OR RATCHET STOP MAKES 1MM SPINDLE FEED



3631-25

(mm)

Code	Range	Accuracy	L	a	b
3631-25	0-25mm/0-1"	±2µm	34	188	28.5
3631-50	25-50mm/1-2"	±2µm	59	211	30
3631-75	50-75mm/2-3"	±3µm	84	240	44
3631-100	75-100mm/3-4"	±3µm	109	264	56
3631-125	100-125mm/4-5"	±3µm	134	289	76
3631-150	125-150mm/5-6"	±3µm	160	314	89

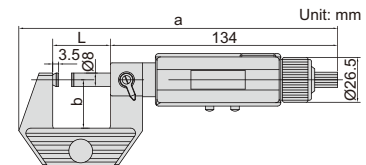

LEVER DEVICE SUITABLE FOR MASS PRODUCTION

NON-ROTATING SPINDLE

DATA OUTPUT

NON-ROTATING SPINDLE DIGITAL MICROMETERS

- Resolution: 0.001mm/0.00005"
- Repeatability: 1µm
- Measuring force: 5-10N
- Lever device suitable for mass production
- Non-rotating spindle, suitable for cylinders
- Quick measurement: one turn of sleeve or ratchet stop makes 1mm spindle feed
- Carbide measuring faces
- Ratchet stop
- Data output
- Button function: mm/inch, max./min. value tracking, tolerance measurement, hold, on/off, zero
- CR2032 battery, automatic power off



QUICK MEASUREMENT
ONE TURN OF SLEEVE OR RATCHET STOP MAKES 1MM SPINDLE FEED



3632-25

lever device

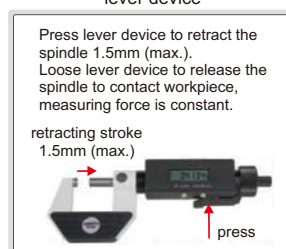

retracting stroke 1.5mm (max.)



(mm)

Code	Range	Accuracy	L	a	b
3632-25	0-25mm/0-1"	±2µm	34	188	28.5

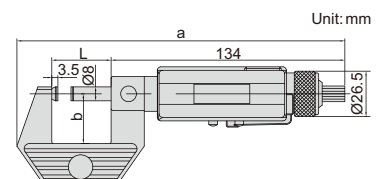

DIGITAL OUTSIDE MICROMETERS (WITH DATA OUTPUT)

DATA
OUTPUT

IP65
WATERPROOF

Ratchet stop type

Code	Range	Accuracy	L	a	b	c
3101-25A*	0-25mm/0-1"	±2µm	34.5	6	25	3
3101-50A*	25-50mm/1-2"	±2µm	59.5	8	32	3
3101-75A*	50-75mm/2-3"	±3µm	84.5	8	44.5	3
3101-100A*	75-100mm/3-4"	±3µm	109.5	8	57	3
3101-125A	100-125mm/4-5"	±3µm	135	10	70	3
3101-150A	125-150mm/5-6"	±3µm	160.5	10	82	3
3101-175A	150-175mm/6-7"	±4µm	186	12	94.5	5.5
3101-200A	175-200mm/7-8"	±4µm	211.5	12	107	5.5
3101-225A	200-225mm/8-9"	±4µm	236	23	129.5	5.5
3101-250A	225-250mm/9-10"	±4µm	261.5	23	142.5	5.5
3101-275A	250-275mm/10-11"	±5µm	287	23	155	5.5
3101-300A	275-300mm/11-12"	±5µm	312.5	23	167.5	5.5

Friction thimble type

Code	Range	Accuracy	L	a	b	c
3101-25FA*	0-25mm/0-1"	±2µm	34.5	6	25	3

* Supplied with manufacturer inspection certificate traceable to DKD Germany



3101-25A

data output

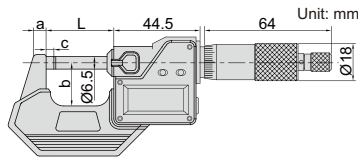

**INSPECTION
CERTIFICATE**
TRACEABLE TO DKD



- Resolution 0.001mm/0.00005" (resolution of 3101-275A and 3101-300A is 0.001mm/0.0001")
- IP65 dust/waterproof
- Button function: on/off, set, mm/inch, ABS/INC
- Data output
- LR44 battery, automatic power off
- Carbide measuring faces
- Supplied with spherical anvil
- Setting standards are included (except 0-25mm/0-1")
- Optional accessory: data output cable (code 7306-30A, 7302-SPC6, 7305-SPC3A)

DIGITAL OUTSIDE MICROMETERS (WITHOUT DATA OUTPUT)

- Resolution 0.001mm/0.00005"
- IP65 dust/waterproof
- Button function: on/off, set, mm/inch, ABS/INC
- No data output
- LR44 battery, automatic power off
- Carbide measuring faces
- Supplied with spherical anvil
- Setting standards are included (except 0-25mm/0-1")

**INSPECTION
CERTIFICATE**
TRACEABLE TO DKD



3108-25A

without data output

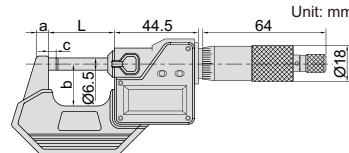
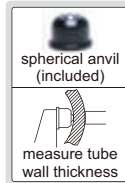

ATTENTION: NO
DATA OUTPUT

IP65
WATERPROOF



Ratchet stop type

Code	Range	Accuracy	L	a	b	c
3108-25A*	0-25mm/0-1"	±2µm	34.5	6	25	3
3108-50A*	25-50mm/1-2"	±2µm	59.5	8	32	3
3108-75A*	50-75mm/2-3"	±3µm	84.5	8	44.5	3
3108-100A*	75-100mm/3-4"	±3µm	109.5	8	57	3
3108-125A	100-125mm/4-5"	±3µm	135	10	70	3
3108-150A	125-150mm/5-6"	±3µm	160.5	10	82	3
3108-175A	150-175mm/6-7"	±4µm	186	12	94.5	5.5
3108-200A	175-200mm/7-8"	±4µm	211.5	12	107	5.5

Friction thimble type

Code	Range	Accuracy	L	a	b	c
3108-25FA*	0-25mm/0-1"	±2µm	34.5	6	25	3

* Supplied with manufacturer inspection certificate traceable to DKD Germany

DIGITAL OUTSIDE MICROMETERS

ATTENTION: NO
DATA OUTPUT

- Resolution 0.001mm/0.00005"
- Button function: on/off, set, mm/inch, ABS/INC
- No data output
- LR44 battery, automatic power off
- Carbide measuring faces
- Friction thimble
- Supplied with spherical anvil
- Setting standards are included (except 0-25mm/0-1")

Code	Range	Accuracy	L	a	b
3109-25A*	0-25mm/0-1"	±2µm	32	6	27.5
3109-50A*	25-50mm/1-2"	±2µm	57	8	37
3109-75A*	50-75mm/2-3"	±3µm	82	8	50
3109-100A*	75-100mm/3-4"	±3µm	107	10	61

* Supplied with manufacturer inspection certificate traceable to DKD Germany



3109-25A

Unit: mm

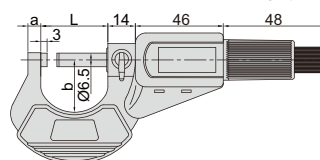

**INSPECTION
CERTIFICATE**
TRACEABLE TO DKD



OUTSIDE MICROMETERS WITH COUNTER

- Counter resolution: 0.01mm
- Thimble graduation: 0.01mm
- Carbide measuring faces
- Meet DIN 863-1
- Ratchet stop
- Supplied with setting standards (except 0-25mm)

**INSPECTION
CERTIFICATE**
TRACEABLE TO DKD



3400-25

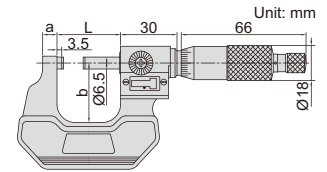

(mm)					
Code	Range	Accuracy	L	a	b
3400-25*	0-25mm	4µm	32	6	26
3400-50*	25-50mm	4µm	57	8	32
3400-75*	50-75mm	5µm	82	8	44.5
3400-100*	75-100mm	5µm	107	8	57

* Supplied with manufacturer inspection certificate traceable to DKD Germany

QUICK FEEDING OUTSIDE MICROMETERS

- Graduation 0.01mm
- 1mm feeding of each turn
- Friction thimble
- Carbide measuring faces
- Meet DIN863-1
- Supplied with setting standards (except 0-25mm)



3208-25B

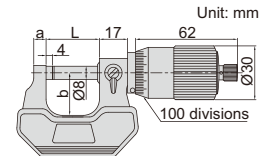

(mm)					
Code	Range	Accuracy	L	a	b
3208-25B	0-25mm	4µm	32	6	24
3208-50B	25-50mm	4µm	57	8	32
3208-75B	50-75mm	5µm	82	8	45
3208-100B	75-100mm	5µm	107	8	57

**INSPECTION
CERTIFICATE**
TRACEABLE TO DKD

1µm GRADUATION OUTSIDE MICROMETERS

- Graduation 0.001mm
- Carbide measuring faces
- Meet DIN863-1
- Supplied with setting standards (except 0-25mm)



3210-25A

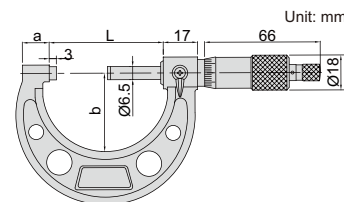

(mm)					
Ratchet stop type					
Code	Range	Accuracy	L	a	b
3210-25A*	0-25mm	4µm	32	9	28
3210-50A*	25-50mm	4µm	57	14	38
3210-75A*	50-75mm	5µm	82	15	49
3210-100A*	75-100mm	5µm	107	15	60
3210-125A	100-125mm	6µm	133	16.5	73
3210-150A	125-150mm	6µm	158	16.5	85
3210-175A	150-175mm	7µm	183	19.4	104
3210-200A	175-200mm	7µm	209	19.4	117

(mm)					
Friction thimble type					
Code	Range	Accuracy	L	a	b
3210-25FA*	0-25mm	4µm	32	9	28
3210-50FA*	25-50mm	4µm	57	14	38

Micrometer set (ratchet stop type)

Code	Range	Micrometers included
3210-753A*	0-75mm	3210-25A, 3210-50A, 3210-75A
3210-1004A*	0-100mm	3210-25A, 3210-50A, 3210-75A, 3210-100A
3210-1506A	0-150mm	3210-25A, 3210-50A, 3210-75A, 3210-100A, 3210-125A, 3210-150A

* Supplied with manufacturer inspection certificate traceable to DKD Germany

OUTSIDE MICROMETERS

**INSPECTION
CERTIFICATE**
TRACEABLE TO DKD



3203-25A



3203-50A

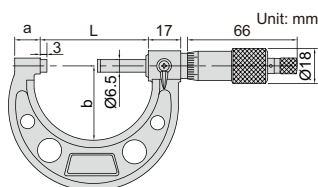

3203-1004A

- Graduation: metric 0.01mm
imperial .0001"
- Carbide measuring faces
- Meet DIN863-1
- Supplied with setting standards
(except 0-25mm and 0-1")

Metric (ratchet stop type)

Code	Range	Accuracy	L	a	b
3203-25A *	0-25mm	4µm	32mm	9mm	28mm
3203-50A *	25-50mm	4µm	57mm	14mm	38mm
3203-75A *	50-75mm	5µm	82mm	15mm	49mm
3203-100A *	75-100mm	5µm	107mm	15mm	60mm
3203-125A	100-125mm	6µm	133mm	16.5mm	73mm
3203-150A	125-150mm	6µm	158mm	16.5mm	85mm
3203-175A	150-175mm	7µm	183mm	19.4mm	104mm
3203-200A	175-200mm	7µm	209mm	19.4mm	117mm
3203-225A	200-225mm	8µm	234mm	19.4mm	130mm
3203-250A	225-250mm	8µm	260mm	19.4mm	142mm
3203-275A	250-275mm	9µm	285mm	19.4mm	155mm
3203-300A	275-300mm	9µm	310mm	19.4mm	168mm

Imperial (ratchet stop type)

Code	Range	Accuracy	L	a	b
3203-1A *	0-1"	.00016"	1.260"	.354"	1.102"
3203-2A *	1-2"	.00016"	2.244"	.551"	1.496"
3203-3A *	2-3"	.00020"	3.228"	.591"	1.929"
3203-4A *	3-4"	.00020"	4.213"	.591"	2.362"
3203-5A *	4-5"	.00024"	5.236"	.650"	2.874"
3203-6A *	5-6"	.00024"	6.220"	.650"	3.346"
3203-7A	6-7"	.00028"	7.205"	.764"	4.094"
3203-8A	7-8"	.00028"	8.228"	.764"	4.606"
3203-9A	8-9"	.00031"	9.213"	.764"	5.118"
3203-10A	9-10"	.00031"	10.236"	.764"	5.591"
3203-11A	10-11"	.00035"	11.220"	.764"	6.102"
3203-12A	11-12"	.00035"	12.205"	.764"	6.614"

Metric micrometer set (ratchet stop type)

Code	Range	Micrometers Included
3203-753A *	0-75mm	3203-25A, 3203-50A, 3203-75A
3203-1004A *	0-100mm	3203-25A, 3203-50A, 3203-75A, 3203-100A
3203-1506A	0-150mm	3203-25A, 3203-50A, 3203-75A, 3203-100A, 3203-125A, 3203-150A
3203-3006A	150-300mm	3203-175A, 3203-200A, 3203-225A, 3203-250A, 3203-275A, 3203-300A
3203-3012A	0-300mm	3203-25A, 3203-50A, 3203-75A, 3203-100A, 3203-125A, 3203-150A, 3203-175A, 3203-200A, 3203-225A, 3203-250A, 3203-275A, 3203-300A

Imperial micrometer set (ratchet stop type)

Code	Range	Micrometers Included
3203-33A *	0-3"	3203-1A, 3203-2A, 3203-3A
3203-44A *	0-4"	3203-1A, 3203-2A, 3203-3A, 3203-4A
3203-66A *	0-6"	3203-1A, 3203-2A, 3203-3A, 3203-4A, 3203-5A, 3203-6A
3203-126A	6-12"	3203-7A, 3203-8A, 3203-9A, 3203-10A, 3203-11A, 3203-12A
3203-1212A	0-12"	3203-1A, 3203-2A, 3203-3A, 3203-4A, 3203-5A, 3203-6A, 3203-7A, 3203-8A, 3203-9A, 3203-10A, 3203-11A, 3203-12A

Imperial (friction thimble type)

Code	Range	Accuracy	L	a	b
3203-1FA *	0-1"	.00016"	1.260"	.354"	1.102"
3203-2FA *	1-2"	.00016"	2.244"	.551"	1.496"
3203-3FA *	2-3"	.00020"	2.244"	.591"	1.929"

* Supplied with manufacturer inspection certificate traceable to DKD Germany or NIST USA

OUTSIDE MICROMETERS

- Graduation 0.01mm
- Carbide measuring faces
- Meet DIN863-1
- Supplied with setting standards (except 0-25mm)

**INSPECTION
CERTIFICATE**
TRACEABLE TO DKD

(mm)					
Code	Range	Accuracy	L	a	b
3202-25A*	0-25mm	4µm	32	6	24
3202-50A*	25-50mm	4µm	57	8	32
3202-75A*	50-75mm	5µm	82	8	45
3202-100A*	75-100mm	5µm	107	8	57
3202-125A	100-125mm	6µm	133	8	70
3202-150A	125-150mm	6µm	125	8	82
3202-175A	150-175mm	7µm	183	8	95
3202-200A	175-200mm	7µm	209	8	107



3202-25A

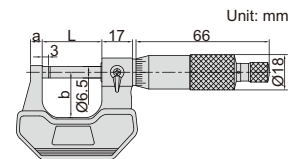

Micrometer set

Code	Range	Micrometers included
3202-753A*	0-75mm	3202-25A, 3202-50A, 3202-75A
3202-1004A*	0-100mm	3202-25A, 3202-50A, 3202-75A, 3202-100A
3202-1506A	0-150mm	3202-25A, 3202-50A, 3202-75A, 3202-100A, 3202-125A, 3202-150A

* Supplied with manufacturer inspection certificate traceable to DKD Germany

LONG SPINDLE OUTSIDE MICROMETERS

- Graduation 0.01mm
- Carbide measuring faces
- Meet DIN863-1
- Ratchet stop
- Supplied with setting standards (except 0-25mm)

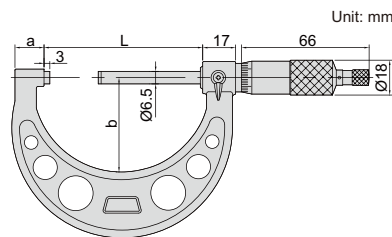

3209-25

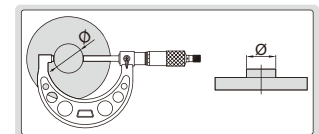
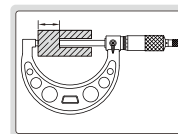

(mm)					
Code	Range	Accuracy	L	a	b
3209-25	0-25mm	4µm	57	14	38
3209-50	25-50mm	4µm	82	15	49
3209-75	50-75mm	5µm	107	15	60
3209-100	75-100mm	5µm	133	16.5	73

OUTSIDE MICROMETERS FOR LEFT OR RIGHT HAND

- Graduation 0.01mm
- Graduations on two sides
- Ratchet stop
- Carbide measuring faces
- Meet DIN863-1
- Supplied with setting standards (except 0-25mm)

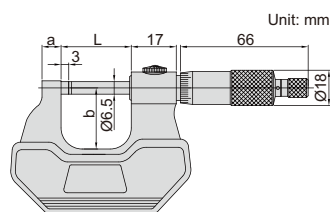

front



back

(mm)					
Code	Range	Accuracy	L	a	b
3236-25B	0-25mm	4µm	32	6	24
3236-50B	25-50mm	4µm	57	8	32

3236-25B

OUTSIDE MICROMETERS WITH INTERCHANGEABLE ANVILS

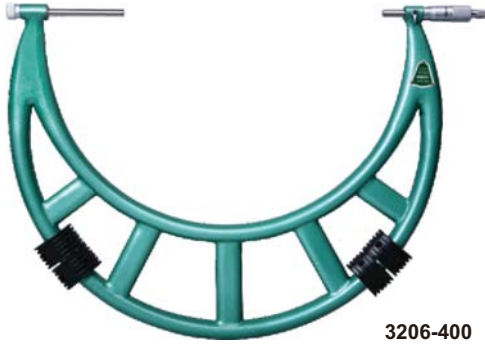

3206-400



3206-150A

- Graduation 0.01mm
- Ratchet stop
- Meet DIN863-3
- Carbide measuring faces
- Supplied with setting standards

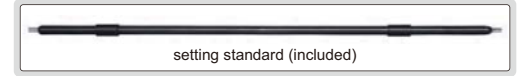
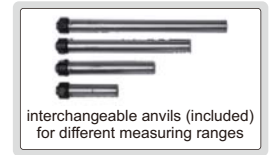

Code	Range	Type	Accuracy	L	b	Setting standard (included)
3206-50A	0-50mm	A	4µm	58	35	25
3206-100A	0-100mm	A	5µm	108	57	25, 50, 75
3206-150A	0-150mm	A	6µm	158	82	25, 50, 75, 100, 125
3206-151A	50-150mm	A	6µm	158	82	50, 75, 100, 125
3206-200A	100-200mm	A	7µm	208	114	100, 125, 150, 175
3206-300A	150-300mm	A	9µm	308	165	150, 175, 200, 225, 250, 275
3206-301A	200-300mm	A	9µm	308	165	200, 225, 250, 275
3206-400	300-400mm	B	11µm	409	224	325, 375
3206-500	400-500mm	B	13µm	509	275	425, 475
3206-600	500-600mm	B	14µm	609	321	525, 575
3206-700	600-700mm	B	16µm	709	371	625, 675
3206-800	700-800mm	B	18µm	809	426	725, 775
3206-900	800-900mm	B	20µm	909	476	825, 875
3206-1000	900-1000mm	B	22µm	1009	576	925, 975

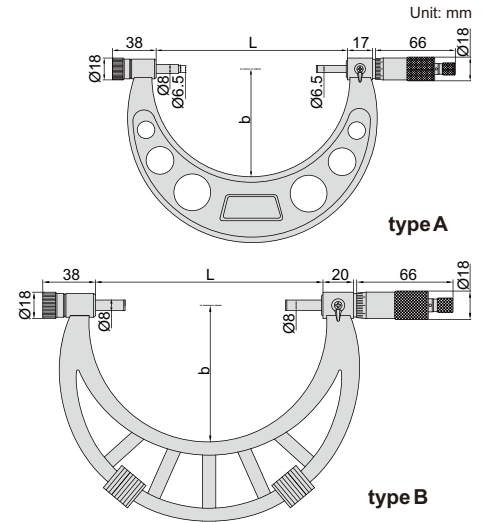

DIGITAL OUTSIDE MICROMETERS WITH INTERCHANGEABLE ANVILS

IP54
WATERPROOF

DATA
OUTPUT

- Resolution 0.001mm/0.0001" (resolution of 3506-100A and 3506-150A is 0.001mm/0.00005")
- IP54 dust/waterproof
- Button function: on/off, set, mm/inch, ABS/INC, data output
- Data output
- LR44 battery, automatic power off
- Ratchet stop
- Carbide measuring faces
- Supplied with setting standards
- Optional accessory: data output cable (code 7306-30, 7302-SPC2A, 7305-SPC3)



3506-100A

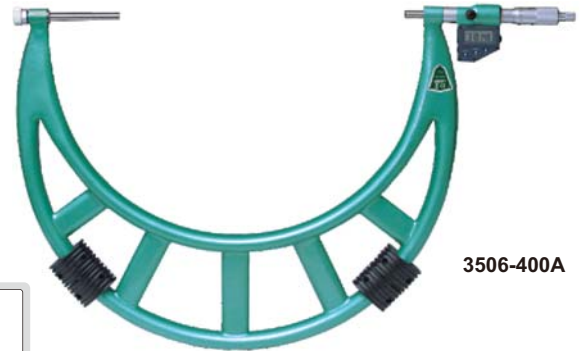

3506-400A

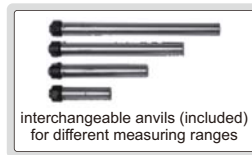
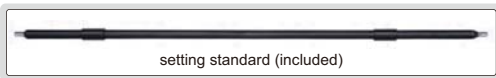

Code	Range	Type	Accuracy	L	b	Setting standard (included)
3506-100A	0-100mm/0-4"	A	±5µm	105	57	25, 50, 75
3506-150A	0-150mm/0-6"	A	±6µm	155	82	25, 50, 75, 100, 125
3506-300A	150-300mm/6-12"	A	±8µm	305	165	150, 175, 200, 225, 250, 275
3506-301A	200-300mm/8-12"	A	±8µm	305	165	200, 225, 250, 275
3506-400A	300-400mm/12-16"	B	±9µm	405	224	325, 375
3506-500A	400-500mm/16-20"	B	±11µm	505	275	425, 475
3506-600A	500-600mm/20-24"	B	±12µm	605	321	525, 575
3506-700A	600-700mm/24-28"	B	±13µm	705	371	625, 675
3506-800A	700-800mm/28-32"	B	±15µm	805	426	725, 775
3506-900A	800-900mm/32-36"	B	±16µm	905	476	825, 875
3506-1000A	900-1000mm/36-40"	B	±17µm	1005	576	925, 975

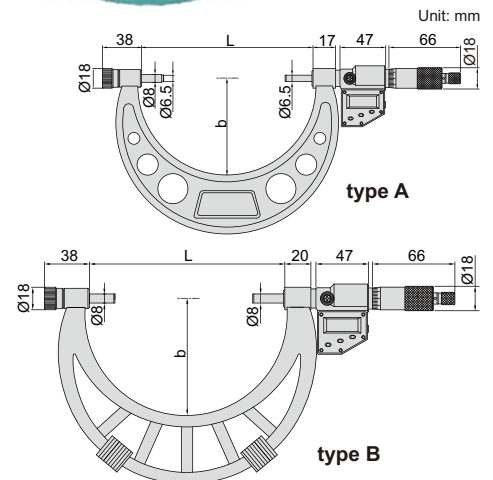

OUTSIDE MICROMETERS WITH EXTENSION ANVIL COLLAR



adjust collars for different measuring ranges

- Graduation 0.01mm
- Adjust collars for different measuring ranges
- Ratchet stop
- Carbide measuring faces
- Supplied with setting standards

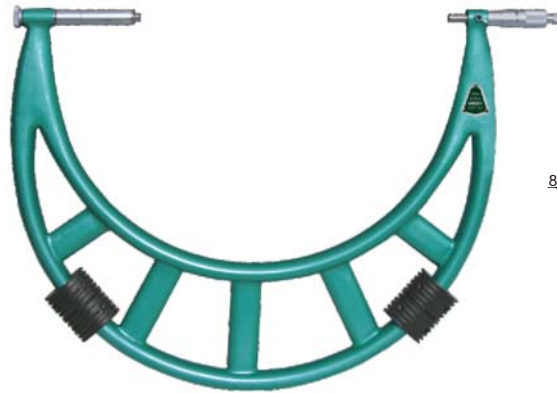

3205-400

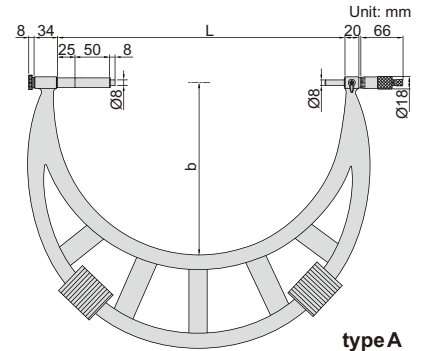

type A

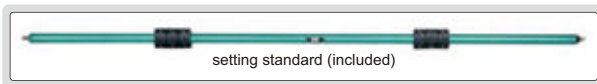

setting standard (included)

(mm)

Code	Range	Type	Accuracy	L	b	Setting standard (included)
3205-400	300-400mm	A	11µm	410	250	325, 375
3205-500	400-500mm	A	13µm	510	295	425, 475
3205-600	500-600mm	A	14µm	610	345	525, 575
3205-700	600-700mm	A	16µm	710	395	625, 675
3205-800	700-800mm	A	18µm	810	445	725, 775
3205-900	800-900mm	A	20µm	910	495	825, 875
3205-1000	900-1000mm	A	22µm	1010	545	925, 975
3205-1200	1000-1200mm	B	22µm	1210	645	1050, 1150
3205-1400	1200-1400mm	B	24µm	1410	745	1250, 1350
3205-1600	1400-1600mm	B	28µm	1610	845	1450, 1550
3205-1800	1600-1800mm	B	31µm	1810	945	1650, 1750
3205-2000	1800-2000mm	B	34µm	2010	1045	1850, 1950

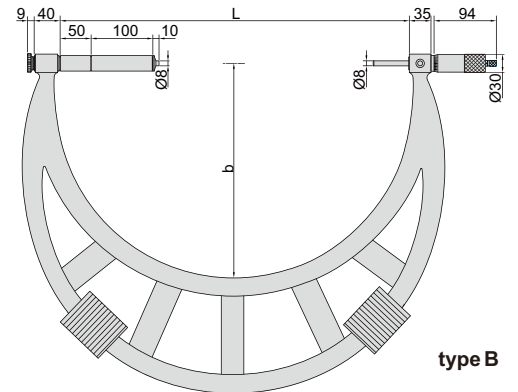

type B

INDICATING MICROMETERS

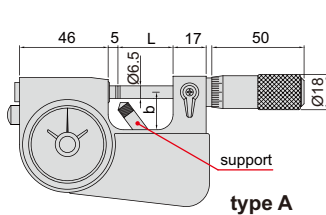

type A

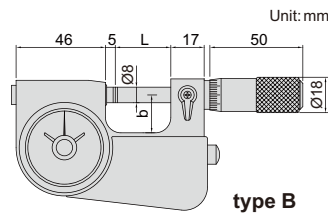

type B

- Meet DIN863-3
- Micrometer head graduation: 0.002mm
- Dial indicator: range ±0.04mm, graduation 0.001mm, accuracy 0.001mm
- Carbide measuring faces
- Supplied with setting standards (except 0-25mm)

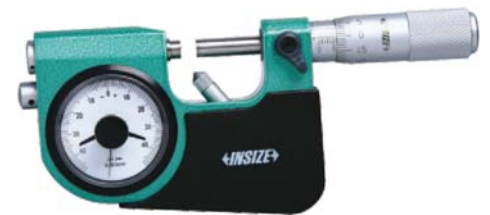

3332-25



3332-25B

(mm)

Code	Micrometer head range	Micrometer head accuracy	Type	L	b	Remark
3332-25	0-25mm	4µm	A	28.5	19	with support
3332-50	25-50mm	4µm	A	53.5	30	with support
3332-75	50-75mm	5µm	A	78.5	45	without support
3332-100	75-100mm	5µm	A	103.5	57	without support
3332-25B	0-25mm	4µm	B	28.5	19	without support

INDICATING MICROMETER

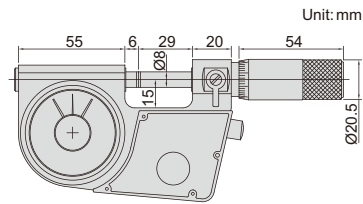

3333-25

- Meet DIN863-3
- Carbide measuring faces
- Measuring force 5-10N

Code	Micrometer head			Dial indicator		
	Range	Graduation	Accuracy	Range	Graduation	Accuracy
3333-25	0-25mm	0.01mm	2µm	±0.07mm	1µm	1µm

LIMIT MICROMETERS

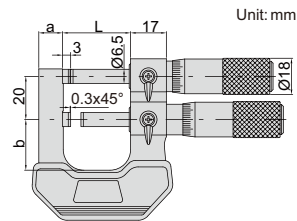

3235-25A

- Used as Go/No-Go gauge by setting upper and lower limits
- Graduation 0.002mm
- Carbide measuring faces
- Supplied with setting standard (except 0-25mm)

Code	Range	Accuracy	(mm)		
			L	a	b
3235-25A	0-25mm	4µm	32	12	24
3235-50A	25-50mm	4µm	57	15	32

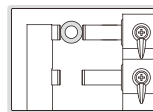

MICROMETERS WITH DIAL INDICATING

ATTENTION: NOT SUITABLE FOR 0.001MM INDICATORS



3331-25A

- Meet DIN863-3
- Micrometer head graduation 0.01mm
- Anvil retracting range: 8mm
- Carbide measuring faces
- Supplied with setting standards (except 0-25mm)
- Optional accessory: dial indicators (graduation 0.01mm), digital indicators (resolution 0.01mm/0.0005")

Code	Micrometer head range	Micrometer head accuracy	(mm)	
			L	b
3331-25A	0-25mm	4µm	67	38
3331-50A	25-50mm	4µm	92.4	50
3331-75A	50-75mm	5µm	117.6	62
3331-100A	75-100mm	5µm	143	70
3331-125A	100-125mm	6µm	168.2	82
3331-150A	125-150mm	6µm	192	94.5
3331-175A	150-175mm	7µm	217	107

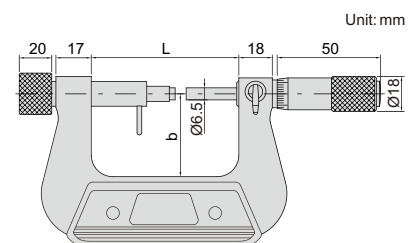

ATTENTION: NOT SUITABLE FOR 0.001MM INDICATORS

MICROMETERS WITH DIAL INDICATOR



3296-100A

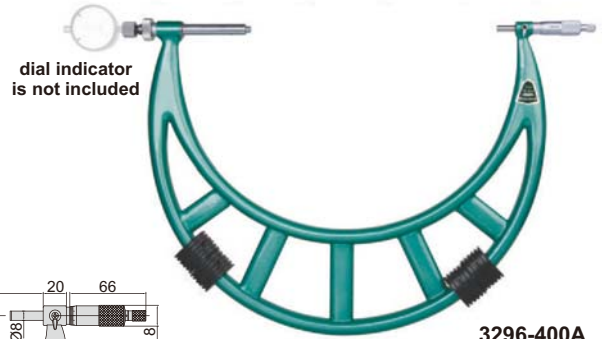

3296-400A

- Meet DIN863-3
- Graduation 0.01mm
- Ratchet stop
- Carbide measuring faces
- Supplied with setting standards
- Optional accessory:
 - dial indicators (graduation 0.01mm)
 - digital indicators (resolution 0.01mm/0.0005")

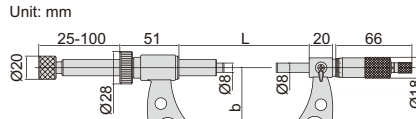

type A

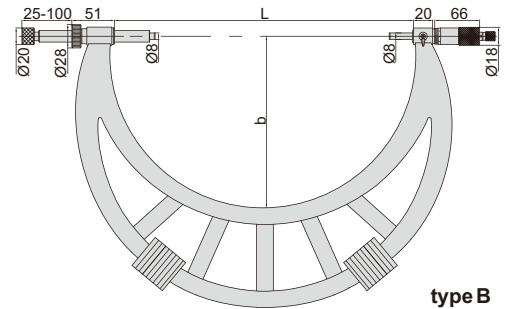

type B

Code	Range	Type	Accuracy	L	b
3296-100A	0-100mm	A	6µm	115	68
3296-200A	100-200mm	A	7µm	215	120
3296-300A	200-300mm	A	8µm	315	170
3296-400A	300-400mm	B	9µm	415	225
3296-500A	400-500mm	B	10µm	515	275
3296-600A	500-600mm	B	11µm	615	325
3296-700A	600-700mm	B	12µm	715	375
3296-800A	700-800mm	B	13µm	815	430
3296-900A	800-900mm	B	14µm	915	480
3296-1000A	900-1000mm	B	15µm	1015	530

ATTENTION: SETTING STANDARDS ARE NOT INCLUDED



MICROMETERS WITH DIAL INDICATOR

- Meet DIN863-3
- Micrometer head graduation: 0.01mm
- Adjust collars for different measuring ranges
- Anvil retracting range: 3mm
- Carbide measuring faces
- Optional accessory: dial indicators or digital indicators, setting standards



3633-300

Code	Range	Micrometer head range	Frame type	L	b
3633-100	0-100mm	25mm	steel plate	116	65
3633-200	100-200mm	25mm	steel plate	217	109
3633-300	200-300mm	25mm	steel plate	317	159
3633-400	300-400mm	25mm	steel plate	417	209
3633-500	400-500mm	25mm	steel tube	517	259
3633-600	500-600mm	25mm	steel tube	617	310
3633-700	600-700mm	25mm	steel tube	717	360
3633-800	700-800mm	25mm	steel tube	817	408
3633-900	800-900mm	25mm	steel tube	917	460
3633-1000	900-1000mm	25mm	steel tube	1017	512

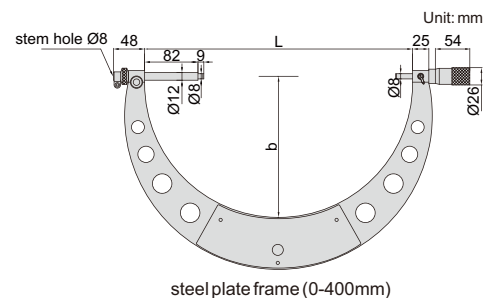

steel plate frame (0-400mm)

- Graduation 0.01mm
- Measure width of grooves inside bores
- Non-rotating spindle
- Two graduations for inside and outside measurement

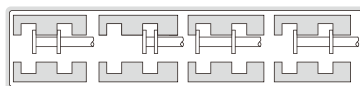

GROOVE MICROMETERS



3287-25A

Code	Range (outside)	Range (inside)	Accuracy
3287-25A	0-25mm	1.6-26.5mm	10µm
3287-50A	25-50mm	26.5-51.5mm	10µm
3287-75A	50-75mm	51.5-76.5mm	10µm
3287-100A	75-100mm	76.5-101.5mm	10µm

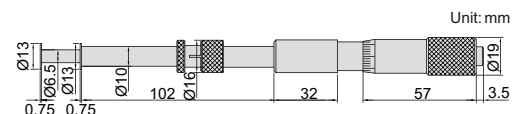

3-WIRES

- Used with standard outside micrometers with spindle $\varnothing 6.35\text{mm}$ or $\varnothing 6.50\text{mm}$ to measure pitch diameter of screw threads
- Diameter accuracy: $\pm 0.5\mu\text{m}$
- Cylindricity: $1\mu\text{m}$
- Hardness: HRC60
- Supplied with manufacturer inspection certificate

**INSPECTION
CERTIFICATE**



VIDEO



7382-19

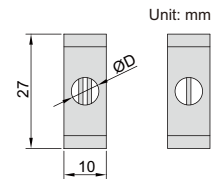

Formula of pitch diameter E
 $E = M - 3d + 0.866025P$
M=measured value of the micrometer
d=diameter of the pin gage (choose diameter of pin gage according to pitch: $d = 0.577P$)
P=screw thread pitch
The formula is suitable for 60° screw

For outside micrometers with spindle $\varnothing 6.35\text{mm}$ (ØD)

Code	Pin gage diameter (Ød)	Applicable pitch
7382-11	0.170mm	0.25mm
7382-12	0.195mm	0.35mm
7382-13	0.220mm	0.35mm
7382-14	0.250mm	0.4mm
7382-15	0.290mm	0.45mm, 0.5mm
7382-16	0.335mm	0.6mm
7382-17	0.390mm	0.7mm
7382-18	0.455mm	0.7mm, 0.75mm, 0.8mm
7382-19	0.530mm	0.9mm
7382-110	0.620mm	1mm
7382-111	0.725mm	1.25mm
7382-112	0.895mm	1.5mm
7382-113	1.100mm	1.75mm
7382-114	1.350mm	2mm
7382-115	1.650mm	2.5mm
7382-116	2.050mm	3mm, 3.5mm
7382-117	2.550mm	4mm, 4.5mm
7382-118	3.200mm	5mm, 5.5mm
7382-1S	18 pairs/set, including all above 3-wires	

For outside micrometers with spindle $\varnothing 6.50\text{mm}$ (ØD)

Code	Pin gage diameter (Ød)	Applicable pitch
7382-21	0.170mm	0.25mm
7382-22	0.195mm	0.35mm
7382-23	0.220mm	0.35mm
7382-24	0.250mm	0.4mm
7382-25	0.290mm	0.45mm, 0.5mm
7382-26	0.335mm	0.6mm
7382-27	0.390mm	0.7mm
7382-28	0.455mm	0.7mm, 0.75mm, 0.8mm
7382-29	0.530mm	0.9mm
7382-210	0.620mm	1mm
7382-211	0.725mm	1.25mm
7382-212	0.895mm	1.5mm
7382-213	1.100mm	1.75mm
7382-214	1.350mm	2mm
7382-215	1.650mm	2.5mm
7382-216	2.050mm	3mm, 3.5mm
7382-217	2.550mm	4mm, 4.5mm
7382-218	3.200mm	5mm, 5.5mm
7382-2S	18 pairs/set, including all above 3-wires	

EXTERNAL SCREW THREAD MICROMETERS

- Meet DIN863-3
- Measure pitch diameter of screw thread
- Graduation 0.01mm
- Ratchet thimble
- Optional accessory: measuring tips for external screw thread micrometer (code 7384)



3639-25

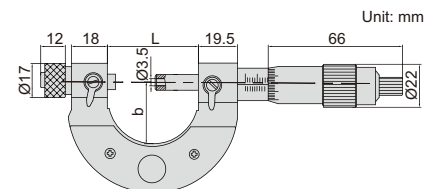

Code	Range	Accuracy	L	b
3639-25	0-25mm	4 μm	45	31
3639-50	25-50mm	4 μm	70	35
3639-75	50-75mm	5 μm	95	48.5
3639-100	75-100mm	5 μm	120	60
3639-125	100-125mm	6 μm	145	72.5
3639-150	125-150mm	6 μm	170	80
3639-175	150-175mm	7 μm	195	97.5
3639-200	175-200mm	7 μm	220	110
3639-225	200-225mm	8 μm	245	122

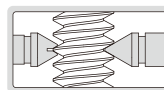



MEASURING TIPS FOR EXTERNAL SCREW THREAD MICROMETERS

TIPS FOR TRAPEZOIDAL, ACME THREAD ARE ALSO AVAILABLE

- Supplied in pair
- Made of hardened steel
- Suitable for 3639 series micrometers



7384-T108

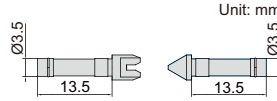

Unit: mm

55° thread angle

Code	Applicable pitch (TPI)
7384-T201	80
7384-T202	72/64
7384-T203	60/48
7384-T204	40/32
7384-T205	28/26/24/22
7384-T206	20/19/18/16
7384-T207	14/12/11
7384-T208	10/9/8
7384-T209	7/6
7384-T210	5/4.5/4
7384-T211	3.5/3.25/3/2.875/2.75
7384-T212	2.625/2.5/2

60° thread angle

Code	Applicable pitch (mm)
7384-T101	0.2
7384-T102	0.225
7384-T103	0.25
7384-T104	0.3
7384-T105	0.35
7384-T106	0.4/0.45
7384-T107	0.5/0.6

60° thread angle

Code	Applicable pitch (mm)
7384-T108	0.7/0.75/0.8
7384-T109	1/1.25
7384-T110	1.5/1.75
7384-T111	2.0/2.5
7384-T112	3.0/3.5
7384-T113	4.0/4.5/5.0
7384-T114	5.5/6.0

SETTING STANDARDS FOR EXTERNAL SCREW THREAD MICROMETERS



7384-A100

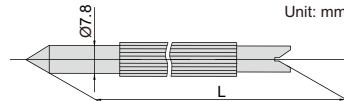

Unit: mm

60° thread angle

Code	L	Accuracy	Code	L	Accuracy
7384-A25	25mm	±1.5µm	7384-A175	175mm	±4.5µm
7384-A50	50mm	±2µm	7384-A200	200mm	±5µm
7384-A75	75mm	±2.5µm	7384-A225	225mm	±5.5µm
7384-A100	100mm	±3µm	7384-A250	250mm	±6µm
7384-A125	125mm	±3.5µm	7384-A275	275mm	±6.5µm
7384-A150	150mm	±4µm	7384-A300	300mm	±7µm

55° thread angle

Code	L	Accuracy	Code	L	Accuracy
7384-B25	25mm	±1.5µm	7384-B175	175mm	±4.5µm
7384-B50	50mm	±2µm	7384-B200	200mm	±5µm
7384-B75	75mm	±2.5µm	7384-B225	225mm	±5.5µm
7384-B100	100mm	±3µm	7384-B250	250mm	±6µm
7384-B125	125mm	±3.5µm	7384-B275	275mm	±6.5µm
7384-B150	150mm	±4µm	7384-B300	300mm	±7µm



MEASURING TIPS FOR INTERNAL SCREW THREAD MICROMETERS

TIPS FOR TRAPEZOIDAL, ACME THREAD ARE ALSO AVAILABLE

- Supplied in pair
- Made of hardened steel
- Suitable for 3640, 3641 series micrometers



7385-T106A

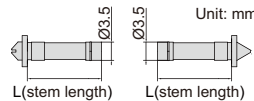

Unit: mm



7385-T106B

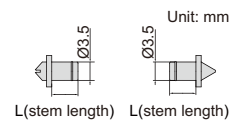

Unit: mm

60° thread angle

Code		Applicable pitch (mm)
L=13.5mm	L=5mm	
7385-T101A	7385-T101B	0.35
7385-T102A	7385-T102B	0.4/0.45
7385-T103A	7385-T103B	0.5/0.6
7385-T104A	7385-T104B	0.7/0.75/0.8
7385-T105A	7385-T105B	1/1.25
7385-T106A	7385-T106B	1.5/1.75
7385-T107A	7385-T107B	2.0/2.5
7385-T108A	7385-T108B	3.0/3.5
7385-T109A	7385-T109B	4.0/4.5/5.0
7385-T110A	7385-T110B	5.5/6.0

55° thread angle

Code		Applicable pitch (TPI)
L=13.5mm	L=5mm	
7385-T201A	7385-T201B	60/48
7385-T202A	7385-T202B	40/32
7385-T203A	7385-T203B	28/26/24/22
7385-T204A	7385-T204B	20/19/18/16
7385-T205A	7385-T205B	14/12/11
7385-T206A	7385-T206B	10/9/8
7385-T207A	7385-T207B	7/6
7385-T208A	7385-T208B	5/4.5/4
7385-T209A	7385-T209B	3.5/3.25/3/2.875/2.75
7385-T210A	7385-T210B	2.625/2.5/2

SCREW THREAD MICROMETERS

- Measure pitch diameter of screw threads
- Graduation 0.01mm
- Non-rotating spindle
- Ratchet stop
- Supplied with 60° setting standards
- Optional accessory: 55° setting standards, measuring tips (code 7381)

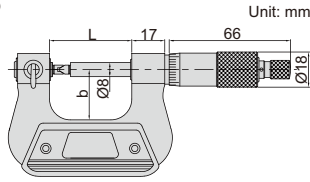

NON-ROTATING SPINDLE

measuring tips are not included



3281-25A

(mm)

Code	Range	L	b	55° setting standard (optional)
3281-25A	0-25mm	42	26	-
3281-50A	25-50mm	67	38	3281-SP1
3281-75A	50-75mm	92	50	3281-SP2
3281-100A	75-100mm	117.6	62	3281-SP3
3281-125A	100-125mm	143	70	3281-SP4
3281-150A	125-150mm	168.2	82	3281-SP5
3281-175A	150-175mm	192	94.5	3281-SP6
3281-200A	175-200mm	217	107	3281-SP7

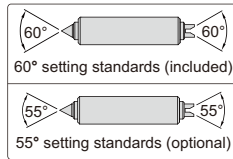
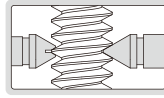

accuracy of micrometers with tips (mm)

Pitch	Range					
	0-25	25-50	50-75	75-100	100-125	125-200
0.4~0.5	±0.01	-	-	-	-	-
0.6~0.8	±0.01	±0.013	-	-	-	-
1~1.25	±0.012	±0.015	±0.017	±0.017	-	-
1.5~2.0	±0.014	±0.017	±0.019	±0.019	±0.020	±0.023
2.5~3.5	±0.016	±0.019	±0.021	±0.021	±0.023	±0.025
4.0~7.0	-	±0.021	±0.023	±0.023	±0.025	±0.028

DIGITAL SCREW THREAD MICROMETERS

- Measure pitch diameter of screw threads
- Resolution 0.001mm/0.00005"
- Button function: on/off, set, mm/inch, ABS/INC, data output
- Data output
- LR44 battery, automatic power off
- Non-rotating spindle
- Ratchet stop
- Supplied with 60° setting standards
- Optional accessory: 55° setting standards, measuring tips (code 7381), data output cable (code 7306-30, 7302-SPC2A, 7305-SPC3)

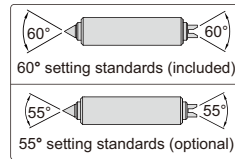

measuring tips are not included



3581-25A

DATA OUTPUT

NON-ROTATING SPINDLE

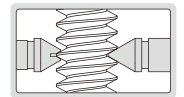

accuracy of micrometers with tips (mm)

Pitch	Range			
	0-25	25-50	50-75	75-100
0.4~0.5	±0.01	-	-	-
0.6~0.8	±0.01	±0.013	-	-
1~1.25	±0.012	±0.015	±0.017	±0.017
1.5~2.0	±0.014	±0.017	±0.019	±0.019
2.5~3.5	±0.016	±0.019	±0.021	±0.021
4.0~7.0	-	±0.021	±0.023	±0.023

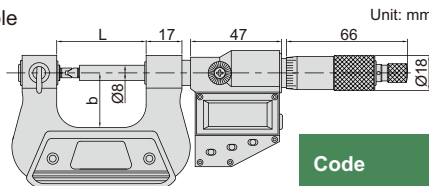

(mm)

Code	Range	L	b	55° setting standard (optional)
3581-25A	0-25mm/0-1"	42	26	-
3581-50A	25-50mm/1-2"	67	38	3281-SP1
3581-75A	50-75mm/2-3"	92	50	3281-SP2
3581-100A	75-100mm/3-4"	117.6	62	3281-SP3

MEASURING TIPS FOR SCREW THREAD MICROMETERS

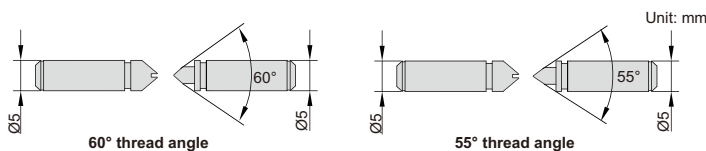

7381-T13

Whitworth thread (55° thread angle)

Metric and unified thread (60° thread angle)

Code	Pitch
7381-T11	0.4-0.5mm/ 64-48TPI
7381-T12	0.6-0.9mm/ 44-28TPI
7381-T13	1-1.75mm/ 24-14TPI
7381-T14	2-3mm/ 13-9TPI
7381-T15	3.5-5mm/ 8-5TPI
7381-T16	5.5-7mm/ 4.5-3.5TPI
7381-TS	6 pairs/set, including all above tips

- Supplied in pair
- Suitable for 3281, 3581 series micrometers

Code	Pitch
7381-T21	60-48TPI
7381-T22	48-40TPI
7381-T23	40-32TPI
7381-T24	32-24TPI
7381-T25	24-18TPI
7381-T26	18-14TPI
7381-T27	14-10TPI
7381-T28	10-7TPI
7381-T29	7-4.5TPI
7381-T210	4.5-3.5TPI
7381-T2S	10 pairs/set, including all above tips



EXTERNAL GEAR TOOTH MICROMETERS

- Meet DIN863-3
- Measure over-pin diameter of gears
- Graduation 0.01mm
- Ratchet stop
- Optional accessory: ball tips (code 7383)

Code	Range	Accuracy	L	b
3636-25	0-25mm	4µm	56	40
3636-50	25-50mm	4µm	81.5	52
3636-75	50-75mm	5µm	106.5	64.5
3636-100	75-100mm	5µm	131.5	76
3636-125	100-125mm	6µm	156.5	88.5
3636-150	125-150mm	6µm	181.5	100
3636-175	150-175mm	7µm	242.5	121.5
3636-200	175-200mm	7µm	242.5	121.5
3636-225	200-225mm	8µm	267.5	134
3636-250	225-250mm	8µm	292.5	146.5
3636-275	250-275mm	9µm	318	159
3636-300	275-300mm	9µm	342.5	171.5
3636-325	300-325mm	10µm	367.5	184
3636-350	325-350mm	10µm	392.5	196.5
3636-375	350-375mm	11µm	417.5	209

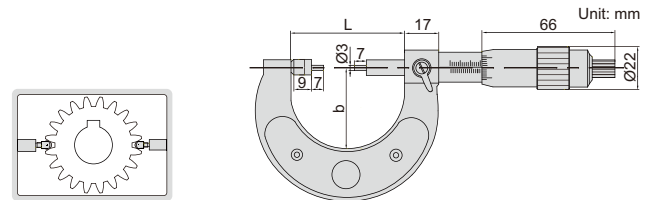

BALL TIPS FOR GEAR TOOTH MICROMETERS



- Supplied in pair
- Made of hardened special steel
- Suitable for 3636, 3637, 3638 series micrometers



7383-8

Code	Ball dia. (D)	Accuracy of D	d
7383-1	SØ1mm	±1µm	Ø3mm
7383-2	SØ2mm	±1µm	Ø3mm
7383-3	SØ3mm	±1µm	Ø3mm
7383-4	SØ4mm	±1µm	Ø3mm
7383-5	SØ5mm	±1µm	Ø3mm
7383-6	SØ6mm	±1µm	Ø3mm
7383-7	SØ7mm	±1µm	Ø3mm
7383-8	SØ8mm	±1µm	Ø3mm

Code	Ball dia. (D)	Accuracy of D	d
7383-9	SØ9mm	±1µm	Ø3mm
7383-10	SØ10mm	±1µm	Ø3mm
7383-11	SØ11mm	±1µm	Ø3mm
7383-12	SØ12mm	±1µm	Ø3mm
7383-13	SØ13mm	±1µm	Ø3mm
7383-14	SØ14mm	±1µm	Ø3mm
7383-15	SØ15mm	±1µm	Ø3mm
7383-16	SØ16mm	±1µm	Ø3mm

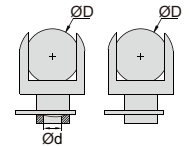

GEAR TOOTH MICROMETERS

- Meet DIN863-3
- Measure over-pin diameter of gears
- Graduation 0.01mm
- Ratchet stop
- Supplied with setting standards (except 0-25mm)
- Optional accessory: ball tips (code 7391)

Code	Range	Accuracy	L	b
3291-25	0-25mm	4µm	67	38
3291-50	25-50mm	4µm	92.4	50
3291-75	50-75mm	5µm	117.6	62
3291-100	75-100mm	5µm	143	70
3291-125	100-125mm	6µm	168.2	82
3291-150	125-150mm	6µm	192	94.5
3291-175	150-175mm	7µm	217	107



3291-25

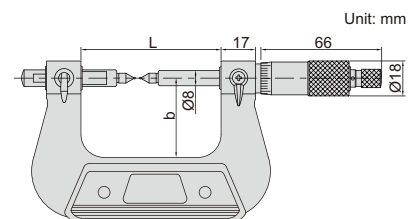
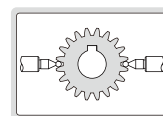

DIGITAL GEAR TOOTH MICROMETERS

IP54
WATERPROOF

DATA
OUTPUT

- Measure over-pin diameter of gears
- Resolution 0.001mm/0.00005"
- IP54 dust/waterproof
- Button function: on/off, set, mm/inch, ABS/INC, data output
- Data output
- LR44 battery, automatic power off
- Ratchet stop
- Supplied with setting standards (except 0-25mm/0-1")
- Optional accessory: ball tips (code 7391), data output cable (code 7306-30, 7302-SPC2A, 7305-SPC3)

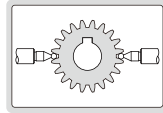

3591-25A

Code	Range	Accuracy	L	b	(mm)
3591-25A	0-25mm/0-1"	±4µm	67	38	
3591-50A	25-50mm/1-2"	±4µm	92.4	50	
3591-75A	50-75mm/2-3"	±5µm	117.6	62	
3591-100A	75-100mm/3-4"	±5µm	143	70	

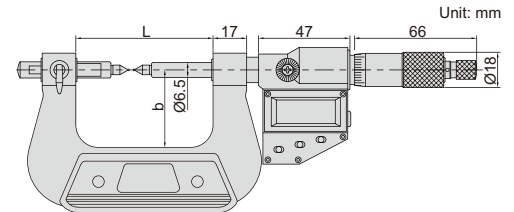

BALL TIPS FOR GEAR TOOTH MICROMETERS

- Supplied in pair
- Suitable for 3291, 3591 series micrometers

Code	Ball dia. (D)	Code	Ball dia. (D)
7391-T2	SØ1.5mm	7391-T7	SØ4.0mm
7391-T3	SØ2.0mm	7391-T8	SØ4.5mm
7391-T4	SØ2.5mm	7391-T9	SØ5.0mm
7391-T5	SØ3.0mm	7391-T10	SØ6.0mm
7391-T6	SØ3.5mm		



7391-T5



POINT MICROMETERS

- Measure the web thickness of drills, small grooves and keyways
- Graduation 0.01mm
- Ratchet stop
- Carbide tips
- Supplied with setting standards (except 0-25mm)



3230-25A

Code	Range	Type	Accuracy	L	b	(mm)
3230-25A	0-25mm	A	4µm	57	32	
3230-50A	25-50mm	A	4µm	82	44.5	
3230-75A	50-75mm	A	5µm	107	57	
3230-100A	75-100mm	A	5µm	132.6	69.5	
3230-25BA	0-25mm	B	4µm	57	32	
3230-50BA	25-50mm	B	4µm	82	44.5	
3230-75BA	50-75mm	B	5µm	107	57	
3230-100BA	75-100mm	B	5µm	132.6	69.5	

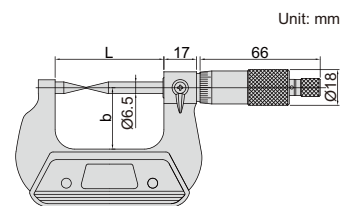
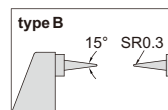
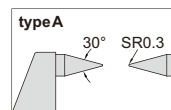

DIGITAL POINT MICROMETERS

- Measure the web thickness of drills, small grooves and keyways
- Resolution 0.001mm/0.00005"
- IP54 dust/waterproof
- Button function: on/off, set, mm/inch, ABS/INC, data output
- Data output
- LR44 battery, automatic power off
- Ratchet stop
- Carbide tips
- Supplied with setting standards (except 0-25mm/0-1")
- Optional accessory: data output cable (code 7306-30, 7302-SPC2A, 7305-SPC3)

IP54
WATERPROOF

DATA
OUTPUT



3530-25A

Code	Range	Type	Accuracy	L	b
3530-25A	0-25mm/0-1"	A	±4μm	57	32
3530-50A	25-50mm/1-2"	A	±4μm	82	44.5
3530-75A	50-75mm/2-3"	A	±5μm	107	57
3530-100A	75-100mm/3-4"	A	±5μm	132.6	69.5
3530-25BA	0-25mm/0-1"	B	±4μm	57	32
3530-50BA	25-50mm/1-2"	B	±4μm	82	44.5
3530-75BA	50-75mm/2-3"	B	±5μm	107	57
3530-100BA	75-100mm/3-4"	B	±5μm	132.6	69.5

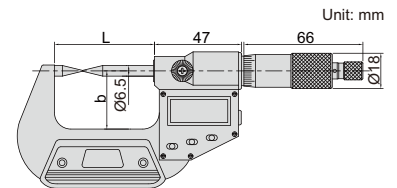
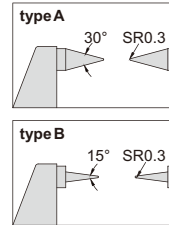

NON-ROTATING
SPINDLE

- Meet DIN863-3
- Measure the groove diameter of shafts and keyways
- Graduation 0.01mm
- Non-rotating spindle
- Ratchet stop
- Supplied with setting standards (except 0-25mm)

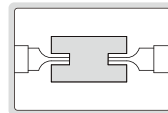

BLADE MICROMETERS

Code	Range	Type	Accuracy	L	b
3232-25A	0-25mm	A	4μm	57	32
3232-50A	25-50mm	A	4μm	82	44.5
3232-75A	50-75mm	A	5μm	107	57
3232-100A	75-100mm	A	5μm	132.6	69.5
3232-125A	100-125mm	A	6μm	158	82
3232-150A	125-150mm	A	6μm	183.4	94.5
3232-175A	150-175mm	A	7μm	208.8	107
3232-25BA	0-25mm	B	4μm	57	32
3232-50BA	25-50mm	B	4μm	82	44.5



3232-25A

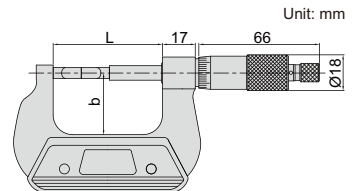
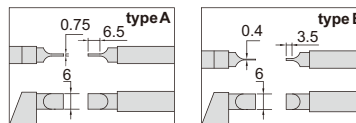

DATA
OUTPUT

NON-ROTATING
SPINDLE

- Measure the groove diameter of shafts and keyways
- Resolution 0.001mm/0.00005"
- Non-rotating spindle
- Button function: on/off, set, mm/inch, ABS/INC, data output
- Data output
- LR44 battery, automatic power off
- Ratchet stop
- Supplied with setting standards (except 0-25mm/0-1")
- Optional accessory: data output cable (code 7306-30, 7302-SPC2A, 7305-SPC3)

Code	Range	Type	Accuracy	L	b
3532-25A	0-25mm/0-1"	A	±4μm	57	32
3532-50A	25-50mm/1-2"	A	±4μm	82	44.5
3532-75A	50-75mm/2-3"	A	±5μm	107	57
3532-100A	75-100mm/3-4"	A	±5μm	132.6	69.5
3532-25BA	0-25mm/0-1"	B	±4μm	57	32
3532-50BA	25-50mm/1-2"	B	±4μm	82	44.5

DIGITAL BLADE MICROMETERS



3532-25A

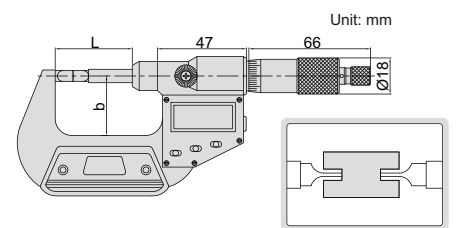
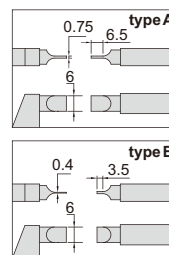

CRIMP HEIGHT MICROMETER

RELATIVE PRODUCT: DIGITAL CRIMP HEIGHT CALIPER (CODE 1165-150A)

- Measure the height of crimp contact
- Graduation 0.01mm
- Ratchet stop



3266-25BA

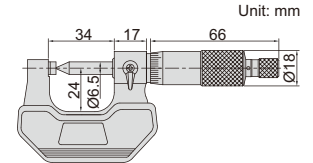
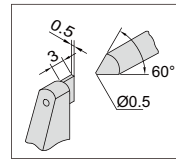
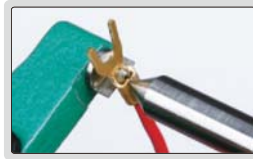

Code	Range	Accuracy
3266-25BA	0-25mm	4µm

DIGITAL CRIMP HEIGHT MICROMETER

IP54
WATERPROOF

DATA
OUTPUT

RELATIVE PRODUCT: DIGITAL CRIMP HEIGHT CALIPER (CODE 1165-150A)

- Measure the height of crimp contact
- Resolution 0.001mm/0.00005"
- IP54 dust/waterproof
- Button function: on/off, set, mm/inch, ABS/INC, data output
- Data output
- LR44 battery, automatic power off
- Ratchet stop
- Optional accessory: data output cable (code 7306-30, 7302-SPC2A, 7305-SPC3)



3566-25BA

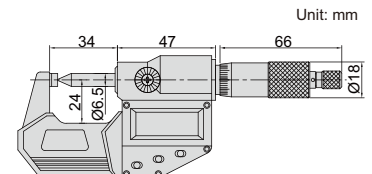
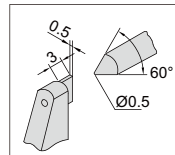
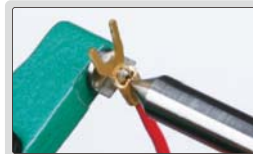

Code	Range	Accuracy
3566-25BA	0-25mm/0-1"	±4µm

SPLINE MICROMETERS

- Meet DIN863-3
- Measure splined shafts, slots and keyways
- Graduation 0.01mm
- Ratchet stop
- Carbide measuring faces
- Supplied with setting standards (except 0-25mm)

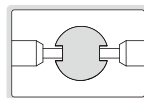

3233-25BA

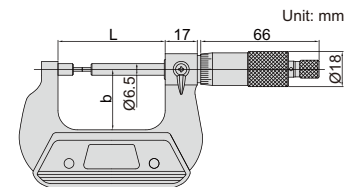
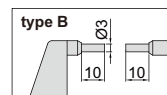
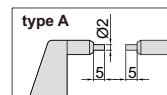

Code	Range	Type	Accuracy	(mm)	
				L	b
3233-25A	0-25mm	A	4µm	57	32
3233-25BA	0-25mm	B	4µm	57	32
3233-50BA	25-50mm	B	4µm	82	44.5
3233-75BA	50-75mm	B	5µm	107	57
3233-100BA	75-100mm	B	5µm	132.6	69.5
3233-125BA	100-125mm	B	6µm	158	82
3233-150BA	125-150mm	B	6µm	183.4	94.5
3233-175BA	150-175mm	B	7µm	208.8	107

IP54
WATERPROOF

DATA
OUTPUT

DIGITAL SPLINE MICROMETERS

- Measure splined shafts, slots and keyways
- Resolution 0.001mm/0.00005"
- IP54 dust/waterproof
- Button function: on/off, set, mm/inch, ABS/INC, data output
- Data output
- LR44 battery, automatic power off
- Ratchet stop
- Carbide measuring faces
- Supplied with setting standards (except 0-25mm/0-1")
- Optional accessory: data output cable (code 7306-30, 7302-SPC2A, 7305-SPC3)



3533-25BA

(mm)

Code	Range	Type	Accuracy	L	b
3533-25A	0-25mm/0-1"	A	±4μm	57	32
3533-50A	25-50mm/1-2"	A	±4μm	82	44.5
3533-75A	50-75mm/2-3"	A	±5μm	107	57
3533-100A	75-100mm/3-4"	A	±5μm	132.6	69.5
3533-25BA	0-25mm/0-1"	B	±4μm	57	32
3533-50BA	25-50mm/1-2"	B	±4μm	82	44.5
3533-75BA	50-75mm/2-3"	B	±5μm	107	57
3533-100BA	75-100mm/3-4"	B	±5μm	132.6	69.5

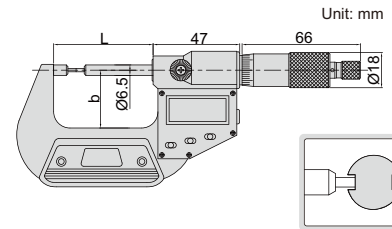
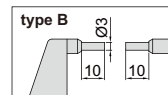
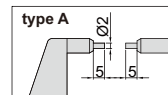

CYLINDRICAL ANVIL TUBE MICROMETERS

- Measure wall thickness of tubes
- Graduation 0.01mm
- Ratchet stop
- Carbide spindle tip
- Supplied with setting standards (except 0-25mm)



3261-25A

Code	Range	Type	Accuracy	L	b
3261-25A	0-25mm	A	6μm	31	24
3261-50A	25-50mm	A	6μm	57	32
3261-25BA	0-25mm	B	6μm	31	24
3261-50BA	25-50mm	B	6μm	57	32
3261-25CA	0-25mm	C	6μm	31	24
3261-25DA	0-25mm	D	6μm	31	24

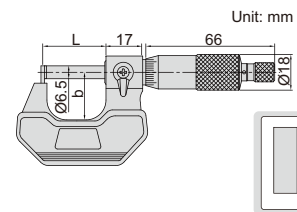
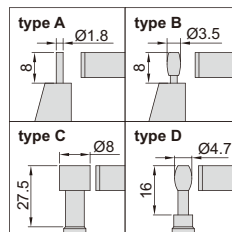

DIGITAL CYLINDRICAL ANVIL TUBE MICROMETERS

IP54
WATERPROOF

DATA
OUTPUT

- Measure wall thickness of tubes
- Resolution 0.001mm/0.00005"
- IP54 dust/waterproof
- Button function: on/off, set, mm/inch, ABS/INC, data output
- Data output
- LR44 battery, automatic power off
- Ratchet stop
- Carbide spindle tip
- Supplied with setting standards (except 0-25mm/0-1")
- Optional accessory: data output cable (code 7306-30, 7302-SPC2A, 7305-SPC3)



3561-25A

Code	Range	Type	Accuracy
3561-25A	0-25mm/0-1"	A	±6μm
3561-25BA	0-25mm/0-1"	B	±6μm
3561-25CA	0-25mm/0-1"	C	±6μm
3561-25DA	0-25mm/0-1"	D	±6μm

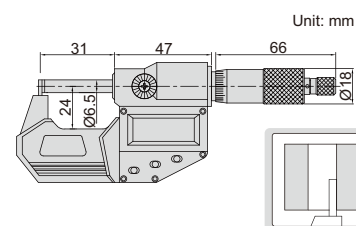
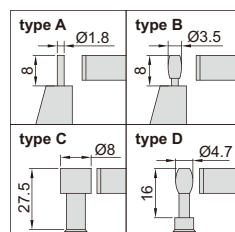

SPHERICAL ANVIL TUBE MICROMETERS

- Meet DIN863-3
- Measure wall thickness of tubes
- Graduation 0.01mm
- Ratchet stop
- Carbide measuring faces
- Supplied with setting standards (except 0-25mm)

Code	Range	Type	Accuracy	L	b
3260-25A	0-25mm	A	4 μ m	32	24
3260-50A	25-50mm	A	4 μ m	57	32
3260-75A	50-75mm	A	5 μ m	82	44.5
3260-100A	75-100mm	A	5 μ m	107	57
3260-25SA	0-25mm	B	4 μ m	32	24
3260-50SA	25-50mm	B	4 μ m	57	32
3260-75SA	50-75mm	B	5 μ m	82	44.5
3260-100SA	75-100mm	B	5 μ m	107	57

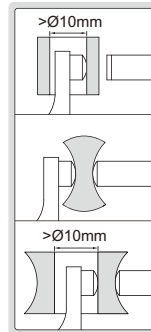

3260-25A

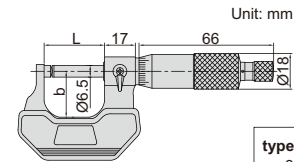

Unit: mm

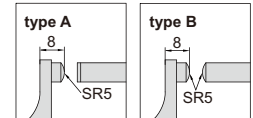

DIGITAL SPHERICAL ANVIL TUBE MICROMETERS

IP54
WATERPROOF

DATA
OUTPUT

- Measure wall thickness of tubes
- Resolution 0.001mm/0.00005"
- IP54 dust/waterproof
- Button function: on/off, set, mm/inch, ABS/INC, data output
- Data output
- LR44 battery, automatic power off
- Ratchet stop
- Carbide measuring faces
- Supplied with setting standards (except 0-25mm/0-1")
- Optional accessory: data output cable (code 7306-30, 7302-SPC2A, 7305-SPC3)

Code	Range	Type	Accuracy	L	b
3560-25A	0-25mm/0-1"	A	\pm 4 μ m	32	24
3560-50A	25-50mm/1-2"	A	\pm 4 μ m	57	32
3560-75A	50-75mm/2-3"	A	\pm 5 μ m	82	44.5
3560-100A	75-100mm/3-4"	A	\pm 5 μ m	107	57
3560-25SA	0-25mm/0-1"	B	\pm 4 μ m	32	24
3560-50SA	25-50mm/1-2"	B	\pm 4 μ m	57	32
3560-75SA	50-75mm/2-3"	B	\pm 5 μ m	82	44.5
3560-100SA	75-100mm/3-4"	B	\pm 5 μ m	107	57

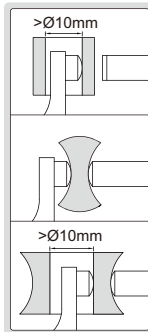

3560-25A

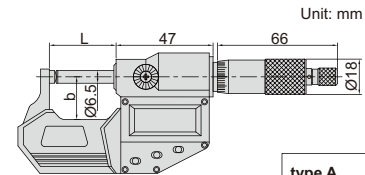

Unit: mm

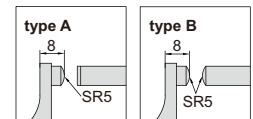

DISK BRAKE MICROMETERS

RELATIVE PRODUCT: DIGITAL DISK BRAKE AND PAD CALIPER
DIGITAL DRUM BRAKE CALIPER (CODE 1162-150A, 1167-150A, 1168-300A)

- Measure thickness of disk brakes
- Graduation 0.01mm
- Ratchet stop
- Carbide measuring faces
- Supplied with setting standards

Code	Range	Accuracy	L
3288-33A	7.6-33mm	5 μ m	64.5
3288-50A	25-50mm	5 μ m	82

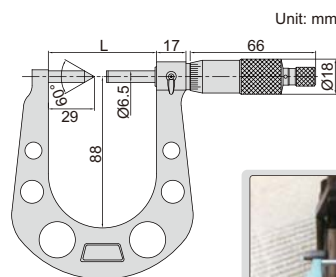

Unit: mm



3288-33A

RELATIVE PRODUCT: DIGITAL DISK BRAKE AND PAD CALIPER
DIGITAL DRUM BRAKE CALIPER (CODE 1162-150A, 1167-150A, 1168-300A)

DIGITAL DISK BRAKE MICROMETERS

- Measure thickness of disk brakes
- Resolution 0.001mm/0.00005"
- IP54 dust/waterproof
- Button function: on/off, set, mm/inch, ABS/INC, data output
- Data output
- LR44 battery, automatic power off
- Ratchet stop
- Carbide measuring faces
- Supplied with setting standards
- Optional accessory: data output cable (code 7306-30, 7302-SPC2A, 7305-SPC3)



IP54
WATERPROOF

DATA
OUTPUT

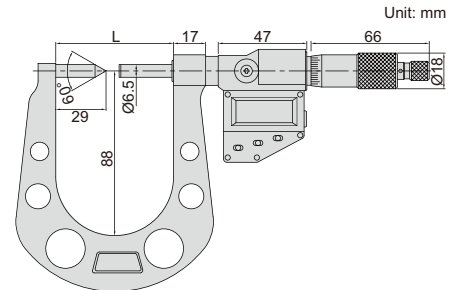

3588-33A

Code	Range	Accuracy	L (mm)
3588-33A	7.6-33mm/0.3-1.3"	±5µm	64.5
3588-50A	25-50mm/1-2"	±5µm	82

SHEET METAL MICROMETERS

- Deep frame suitable for sheet metal, paper and plastic
- Graduation 0.01mm
- Ratchet stop
- Carbide measuring faces

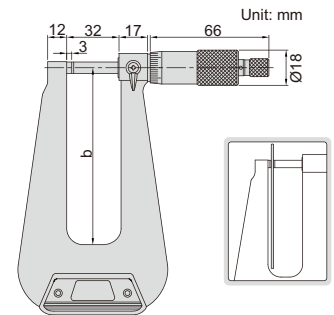

3239-253

Code	Range	Type	Accuracy	b (mm)
3239-253	0-25mm	A	7µm	155
3239-253F	0-25mm	B	7µm	155
3239-254F	0-25mm	B	10µm	310
3239-253S	0-25mm	C	7µm	155

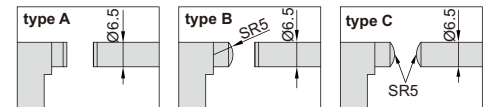

DIGITAL SHEET METAL MICROMETERS

IP54
WATERPROOF

DATA
OUTPUT

- Deep frame suitable for sheet metal, paper and plastic
- Resolution 0.001mm/0.00005"
- IP54 dust/waterproof
- Button function: on/off, set, mm/inch, ABS/INC, data output
- Data output
- LR44 battery, automatic power off
- Ratchet stop
- Carbide measuring faces
- Optional accessory: data output cable (code 7306-30, 7302-SPC2A, 7305-SPC3)

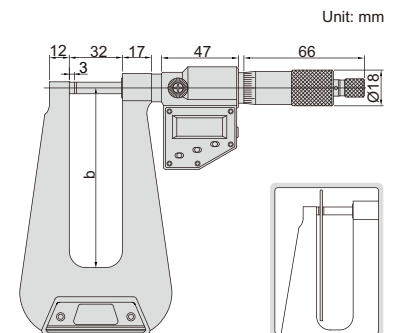

3539-253A

Code	Range	Type	Accuracy	b (mm)
3539-253A	0-25mm/0-1"	A	±7µm	155
3539-253FA	0-25mm/0-1"	B	±7µm	155
3539-254FA	0-25mm/0-1"	B	±10µm	310
3539-253SA	0-25mm/0-1"	C	±7µm	155

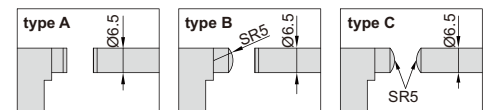

INTERCHANGEABLE ANVIL MICROMETERS

- Measure tube thickness, shoulder edge distance, rivet head height, etc.
- Supplied with flat anvil and rod anvil
- Graduation 0.01mm
- Ratchet stop
- Carbide spindle tip
- Setting standards are included (except 0-25mm)

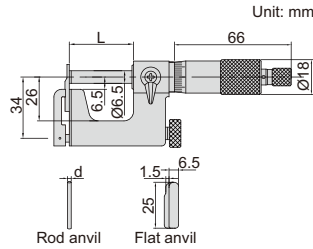

3262-25A

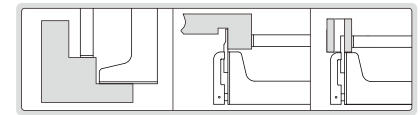

(mm)

Code	Range	Accuracy	L	d
3262-25A	0-25mm	4µm	28.5	Ø3
3262-50A	25-50mm	4µm	53.5	Ø5

DIGITAL INTERCHANGEABLE ANVIL MICROMETERS

IP54
WATERPROOF

DATA
OUTPUT

- Measure tube thickness, shoulder edge distance, rivet head height, etc.
- Supplied with flat anvil and rod anvil
- Resolution 0.001mm/0.00005"
- IP54 dust/waterproof
- Button function: on/off, set, mm/inch, ABS/INC, data output
- Data output
- LR44 battery, automatic power off
- Ratchet stop
- Carbide spindle tip
- Setting standards are included (except 0-25mm/0-1")
- Optional accessory: data output cable (code 7306-30, 7302-SPC2A, 7305-SPC3)



3562-25A

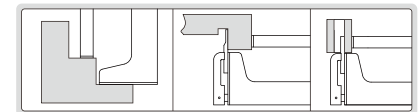
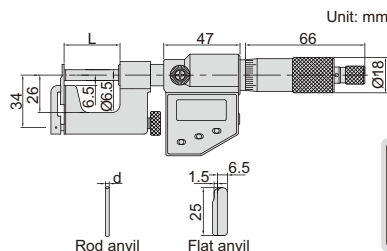

(mm)

Code	Range	Accuracy	L	d
3562-25A	0-25mm/0-1"	±4µm	28.5	Ø3
3562-50A	25-50mm/1-2"	±4µm	53.5	Ø5

V-ANVIL MICROMETERS

- Meet DIN863-3
- Measure the outside diameter of cutting tools (such as taps, reamers, end mills) with 3 or 5 flutes
- Graduation 0.01mm
- Ratchet stop
- Carbide measuring faces
- Supplied with setting standards



3290-153A

Code	Range	Flutes	Accuracy
3290-153A	1-15mm	3	4µm
3290-203A	5-20mm	3	4µm
3290-353A	20-35mm	3	5µm
3290-503A	35-50mm	3	5µm
3290-653A	50-65mm	3	6µm
3290-803A	65-80mm	3	6µm
3290-953A	80-95mm	3	7µm
3290-255A	5-25mm	5	4µm
3290-455A	25-45mm	5	5µm
3290-655A	45-65mm	5	6µm
3290-855A	65-85mm	5	7µm

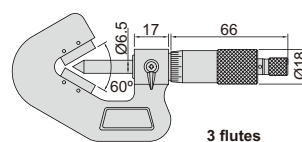

3 flutes

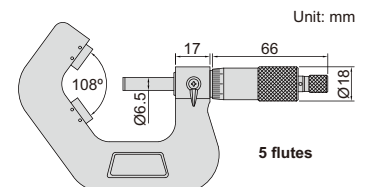

Unit: mm

5 flutes

DIGITAL V-ANVIL MICROMETERS

- Measure the outside diameter of cutting tools (such as taps, reamers, end mills) with 3 flutes
- Resolution 0.001mm/0.00005"
- IP54 dust/waterproof
- Button function: on/off, set, mm/inch, ABS/INC, data output
- Data output
- LR44 battery, automatic power off
- Ratchet stop
- Carbide measuring faces
- Supplied with setting standards
- Optional accessory: data output cable (code 7306-30, 7302-SPC2A, 7305-SPC3)



IP54
WATERPROOF

DATA
OUTPUT

3590-153A

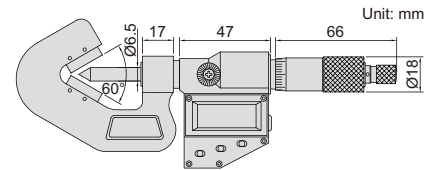

Code	Range	Flutes	Accuracy
3590-153A	1-15mm/0.04-0.6"	3	±4µm
3590-203A	5-20mm/0.2-0.8"	3	±4µm
3590-353A	20-35mm/0.8-1.4"	3	±5µm
3590-503A	35-50mm/1.4-2.0"	3	±5µm

NON-ROTATING
SPINDLE

NON-ROTATING SPINDLE UNIVERSAL MICROMETERS

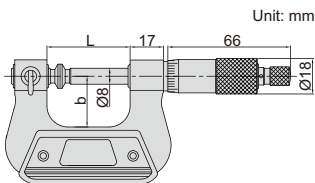

3280-25A

- Meet DIN863-3
- Graduation 0.01mm
- Non-rotating spindle
- Ratchet stop
- Supplied with 7 pairs of anvil/spindle tip
- Setting standards are included (except 0-25mm)
- Optional accessory: 55° anvil/spindle tip (code 3280-SP1 and 3280-SP2)

Code	Range	Accuracy	L	b
3280-25A	0-25mm	4µm	42	26
3280-50A	25-50mm	4µm	67	38

55° anvil/spindle tip (optional)

Code	Tip	Diagram	Unit: mm
Code 3280-SP1	Knife-edge		
Code 3280-SP2	Point		

Anvil/spindle tip (included)

Unit: mm

Tip Type	Diagram	Photograph
Flat		
Spherical		
Spline		
Disk		
Blade		
Knife-edge		
Point		

IP54
WATERPROOF

DATA
OUTPUT

DIGITAL UNIVERSAL MICROMETERS

- Resolution 0.001mm/0.00005"
- IP54 dust/waterproof
- Button function: on/off, set, mm/inch, ABS/INC, data output
- Data output
- LR44 battery, automatic power off
- Ratchet stop
- Supplied with 7 pairs of anvil/spindle tip (same as series 3280)
- Setting standards are included (except 0-25mm/0-1")
- Optional accessory: 55° anvil/spindle tip code 3280-SP1 and 3280-SP2 (same as series 3280), data output cable (code 7306-30, 7302-SPC2A, 7305-SPC3)



3580-25A

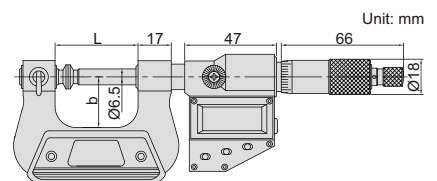

Code	Range	Accuracy	L	b
3580-25A	0-25mm/0-1"	±4µm	42	26
3580-50A	25-50mm/1-2"	±4µm	67	38

DISK MICROMETERS

- Meet DIN863-3
- Measure root tangent length of gear
- Graduation 0.01mm
- Ratchet stop
- Supplied with setting standards

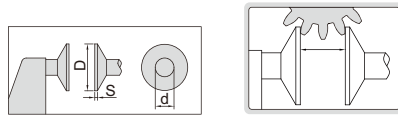

3282-25

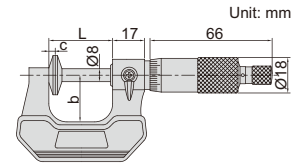

(mm)

Code	Range	Accuracy	Parallelism	L	b	c	D	S	d
3282-25	0-25mm	4µm	5µm	34	24	3.3	Ø20	0.7	Ø8
3282-50	25-50mm	4µm	5µm	59	32	3.3	Ø20	0.7	Ø8
3282-75	50-75mm	5µm	5µm	85	45	3.3	Ø20	0.7	Ø8
3282-100	75-100mm	5µm	5µm	110	57	3.3	Ø20	0.7	Ø8

NON-ROTATING SPINDLE DISK MICROMETERS

- Meet DIN863-3
- Measure root tangent length of gear
- Graduation 0.01mm
- Non-rotating spindle
- Ratchet stop
- Supplied with setting standards

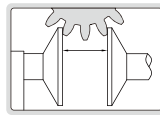

NON-ROTATING SPINDLE



3294-25

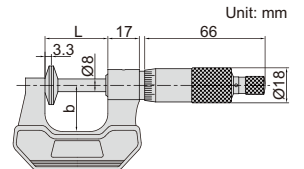

(mm)

Code	Range	Accuracy	Parallelism	L	b
3294-25	0-25mm	4µm	5µm	34	24
3294-50	25-50mm	4µm	5µm	59	32
3294-75	50-75mm	5µm	5µm	85	45
3294-100	75-100mm	5µm	5µm	110	57

DIGITAL NON-ROTATING SPINDLE DISK MICROMETERS

- Measure root tangent length of gear
- Resolution 0.001mm/0.00005"
- Non-rotating spindle
- Button function: on/off, set, mm/inch, ABS/INC, data output
- Data output
- LR44 battery, automatic power off
- Ratchet stop
- Supplied with setting standards
- Optional accessory: data output cable (code 7306-30, 7302-SPC2A, 7305-SPC3)

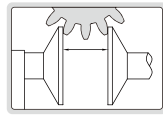

NON-ROTATING SPINDLE

DATA OUTPUT

3594-25A

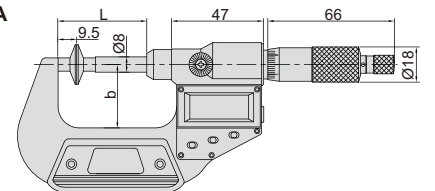

(mm)

Code	Range	Accuracy	Parallelism	L	b
3594-25A	0-25mm/0-1"	±4µm	5µm	43	32
3594-50A	25-50mm/1-2"	±4µm	5µm	68	44.5
3594-75A	50-75mm/2-3"	±5µm	5µm	93	57
3594-100A	75-100mm/3-4"	±5µm	5µm	118.5	70

CALIPER TYPE MICROMETERS

- Graduation 0.01mm
- Non-rotating spindle
- Ratchet stop
- Carbide measuring faces
- Supplied with setting standards (except 0-25mm)

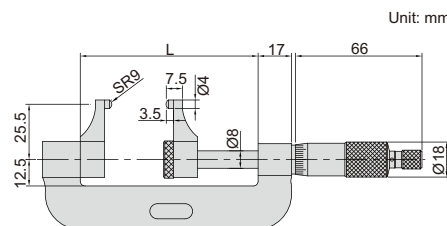

Unit: mm

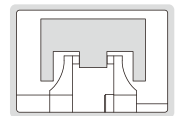

3238-25

Code	Range	Accuracy	L
3238-25	0-25mm	5µm	56
3238-50	25-50mm	6µm	81

SHEET METAL MICROMETER

- Meet DIN863-3
- Measure thickness of sheet metal, paper, plastic and rubber parts
- Graduation 0.01mm
- Ratchet stop
- Carbide measuring faces

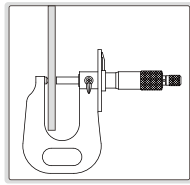

3263-25A

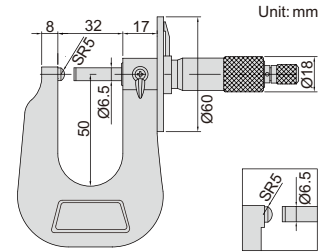

Code	Range	Accuracy
3263-25A	0-25mm	4µm

HUB MICROMETERS

- Meet DIN863-3
- Measure hub thickness and shoulder inside a bore
- Graduation 0.01mm
- Ratchet stop
- Carbide measuring faces
- Supplied with setting standards (except 0-25mm)



3292-25

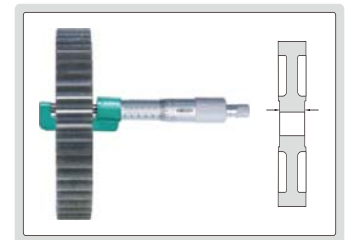

Code	Range	Accuracy	h1	h2	H
3292-25	0-25mm	4µm	6	9	18.7
3292-50	25-50mm	4µm	6.5	11	21.2
3292-75	50-75mm	5µm	6.5	11	21.2
3292-100	75-100mm	5µm	6.5	11	21.2

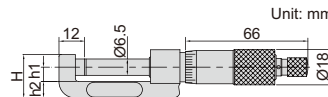

WIRE MICROMETER

- Meet DIN863-3
- Measure diameter of wires and small balls
- Graduation 0.01mm
- Ratchet stop
- Carbide measuring faces



3285-10

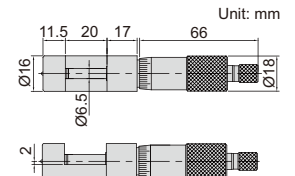
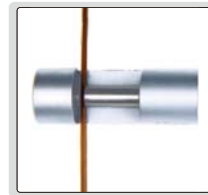

Code	Range	Accuracy
3285-10	0-10mm	4µm

CAN SEAM MICROMETERS



3293-131



3293-132



3293-133

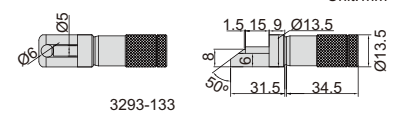
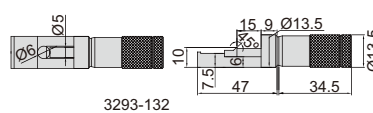
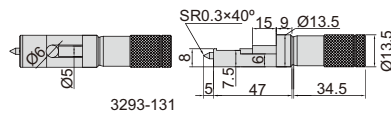

- Measure the width, height and depth of can seams
- Graduation 0.01mm

Code	Range	Accuracy
3293-131	0-13mm	4µm
3293-132	0-13mm	4µm
3293-133	0-13mm	4µm

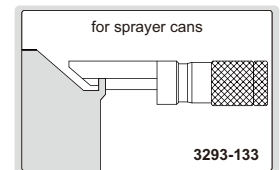
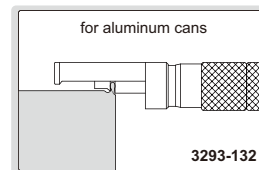
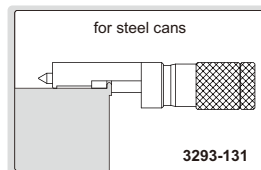

MICROMETER MEASURING FORCE DETECTOR

- For outside micrometers
0-25mm/0-1", 25-50mm/1-2",
50-75mm/2-3" and 75-100mm/3-4"

Code	Measuring force
6315	5-12N

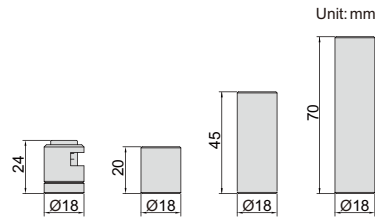

6315

OPTICAL PARALLELS

- Check the flatness and parallelism of measuring faces of micrometer
- Flatness of A and B: $0.03\mu\text{m}$
- Parallelism between A and B: $0.6\mu\text{m}$



4184-41A

Code	Parallels included (b)	ØD	Applicable micrometer
4184-41A	15.62mm, 15.75mm, 15.87mm, 16.00mm	30mm	0-25mm
4184-42A	40.62mm, 40.75mm, 40.87mm, 41.00mm	30mm	25-50mm
4184-43B	65.62mm, 65.75mm, 65.87mm, 66.00mm	40mm	50-75mm
4184-44B	90.62mm, 90.75mm, 90.87mm, 91.00mm	50mm	75-100mm

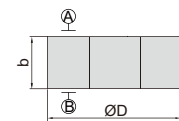

MICROMETER STAND

- Suitable for micrometers up to 100mm

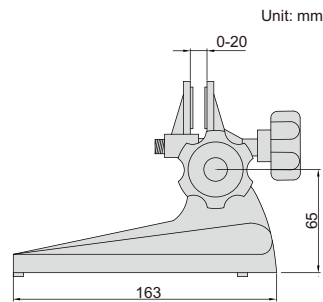

6301

Code
6301

- Suitable for inside micrometers

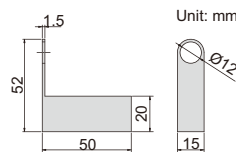

6301-1

Code	Description	Applicable products
6301-1	clamp for inside micrometers	all sizes of 3220 series

- Suitable for three points internal micrometers

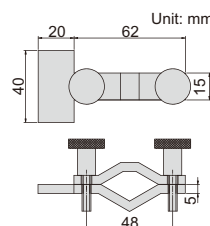

6301-2

Code	Description	Applicable products
6301-2	clamp for three points internal micrometers	up to 100mm of 3127 and 3227 series

MICROMETER STAND

- Suitable for micrometers up to 100mm



6300

Unit: mm

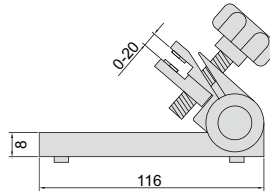

Code
6300

MICROMETER SETTING STANDARDS



6310-100

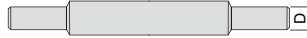

type A



6310-300

(mm)				
Code	Length	Type	Accuracy	D
6310-25	25	A	±1.5µm	Ø7
6310-50	50	A	±2µm	Ø7
6310-75	75	A	±2.5µm	Ø7
6310-100	100	A	±3µm	Ø8
6310-125	125	A	±3.5µm	Ø8
6310-150	150	A	±4µm	Ø8
6310-175	175	A	±4.5µm	Ø8
6310-200	200	A	±5µm	Ø8
6310-225	225	A	±5.5µm	Ø8
6310-250	250	A	±6µm	Ø8
6310-275	275	A	±6.5µm	Ø8
6310-300	300	B	±7µm	Ø16
6310-325	325	B	±7.5µm	Ø16
6310-350	350	B	±8µm	Ø16
6310-375	375	B	±8.5µm	Ø16
6310-400	400	B	±9µm	Ø16
6310-425	425	B	±9.5µm	Ø16

(mm)				
Code	Length	Type	Accuracy	D
6310-450	450	B	±10µm	Ø16
6310-475	475	B	±10.5µm	Ø16
6310-500	500	B	±11µm	Ø16
6310-525	525	B	±11.5µm	Ø16
6310-575	575	B	±12.5µm	Ø16
6310-625	625	B	±13.5µm	Ø16
6310-675	675	B	±14.5µm	Ø16
6310-725	725	B	±15.5µm	Ø16
6310-775	775	B	±16.5µm	Ø16
6310-825	825	B	±17.5µm	Ø16
6310-875	875	B	±18.5µm	Ø16
6310-925	925	B	±19.5µm	Ø16
6310-975	975	B	±20.5µm	Ø16
6310-1050	1050	B	±22µm	Ø23
6310-1150	1150	B	±24µm	Ø23
6310-1250	1250	B	±26µm	Ø23
6310-1350	1350	B	±28µm	Ø23

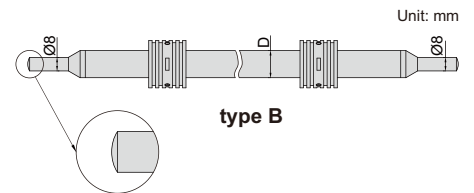

type B

Unit: mm

(mm)				
Code	Length	Type	Accuracy	D
6310-1450	1450	B	±30µm	Ø23
6310-1550	1550	B	±32µm	Ø23
6310-1650	1650	B	±34µm	Ø23
6310-1750	1750	B	±36µm	Ø23
6310-1850	1850	B	±38µm	Ø23
6310-1950	1950	B	±40µm	Ø23

IP54 WATERPROOF **DATA OUTPUT**

- Resolution 0.001mm/0.00005"
- IP54 dust/waterproof
- Button function: on/off, set, mm/inch, ABS/INC, data output
- Data output
- LR44 battery, automatic power off
- Ratchet stop
- Optional accessory: data output cable (code 7306-30, 7302-SPC2A, 7305-SPC3)



6353-25W

DIGITAL MICROMETER HEADS

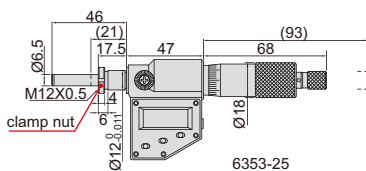

6353-25

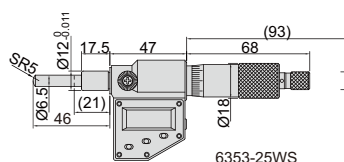

6353-25WS

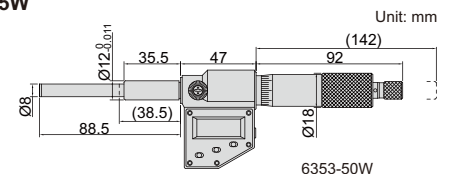

6353-50W

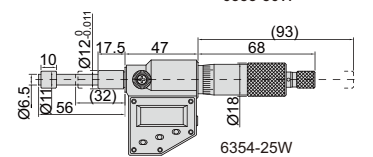

6354-25W

Rotating spindle

Code	Range	Stem	Spindle tip	Accuracy
6353-25	0-25mm/0-1"	with clamp nut	flat (carbide)	±2µm
6353-25W	0-25mm/0-1"	plain	flat (carbide)	±2µm
6353-25S	0-25mm/0-1"	with clamp nut	spherical (SR5)	±2µm
6353-25WS	0-25mm/0-1"	plain	spherical (SR5)	±2µm
6353-50W	0-50mm/0-2"	plain	flat (carbide)	±4µm

Non-rotating spindle

Code	Range	Stem	Spindle tip	Accuracy
6354-25W	0-25mm/0-1"	plain	flat	±2µm

SMALL MICROMETER HEAD

- Graduation 0.02mm



6372-5WS

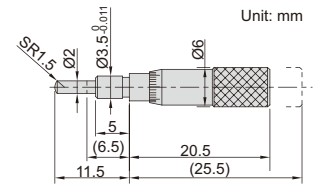

Code	Range	Stem	Spindle tip	Accuracy
6372-5WS	0-5mm	plain	spherical (SR1.5)	5µm

SMALL MICROMETER HEADS

- Range 0-6.5mm
- Graduation 0.01mm
- Accuracy 5µm



6385-65W

Code	Stem	Spindle tip
6385-65	with clamp nut	flat
6385-65W	plain	flat
6385-65S	with clamp nut	spherical (SR3)
6385-65WS	plain	spherical (SR3)

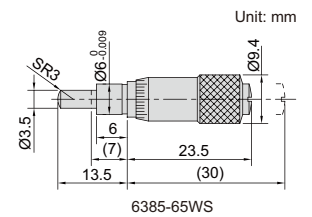
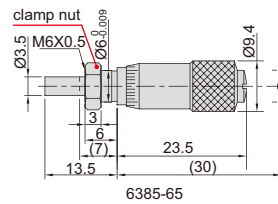

LARGE THIMBLE MICROMETER HEADS

- Meet DIN863-2
- Large thimble diameter for easy reading
- Graduation 0.01mm
- Accuracy 3µm

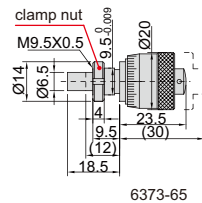

6373-65

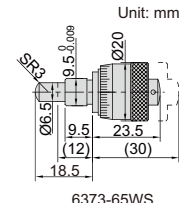

6373-65WS



6373-65

Code	Range	Stem	Spindle tip
6373-65	0-6.5mm	with clamp nut	flat
6373-65W	0-6.5mm	plain	flat
6373-65S	0-6.5mm	with clamp nut	spherical (SR3)
6373-65WS	0-6.5mm	plain	spherical (SR3)
6373-13	0-13mm	with clamp nut	flat
6373-13W	0-13mm	plain	flat

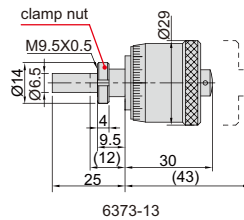

6373-13

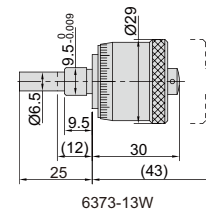

6373-13W



6373-13

MICROMETER HEADS WITH ZERO ADJUSTABLE THIMBLE

- Meet DIN863-2
- Range 0-13mm
- Graduation 0.01mm
- Accuracy 3µm
- The thimble can be set to zero at any position

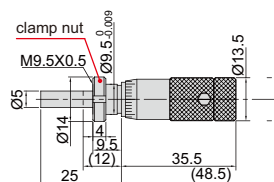

6384-13

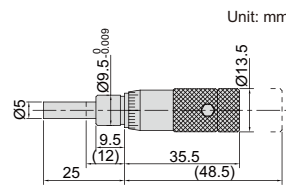

6384-13W



6384-13W

Code	Stem	Spindle tip
6384-13	with clamp nut	flat
6384-13W	plain	flat

MICROMETER HEADS

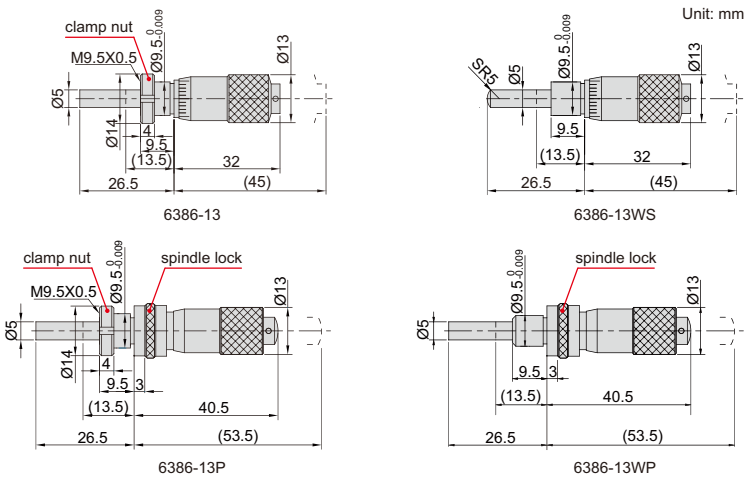

6386-13W



6386-13P

Code	Range	Stem	Spindle tip	Remark	Accuracy
6386-13	0-13mm	with clamp nut	flat		3µm
6386-13W	0-13mm	plain	flat		3µm
6386-13S	0-13mm	with clamp nut	spherical (SR5)		3µm
6386-13WS	0-13mm	plain	spherical (SR5)		3µm
6386-13P	0-13mm	with clamp nut	flat	with spindle lock	3µm
6386-13WP	0-13mm	plain	flat	with spindle lock	3µm

- Meet DIN863-2
- Graduation 0.01mm

MICROMETER HEADS

- Meet DIN863-2
- Graduation 0.01mm
- Accuracy 3µm



6387-15WS

Code	Range	Stem	Spindle tip
6387-15	0-15mm	with clamp nut	flat
6387-15W	0-15mm	plain	flat
6387-15S	0-15mm	with clamp nut	spherical (SR5)
6387-15WS	0-15mm	plain	spherical (SR5)

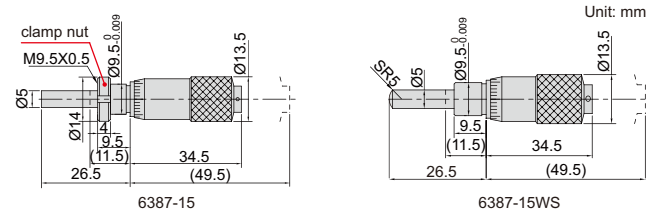

MICROMETER HEADS



6381-25

6381-25P

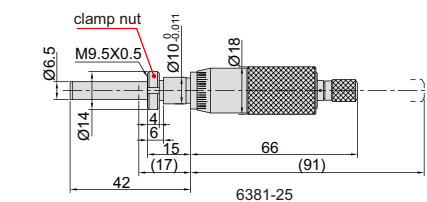
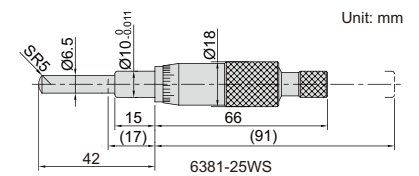

6381-25

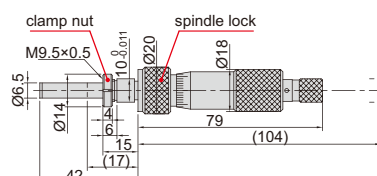

6381-25P

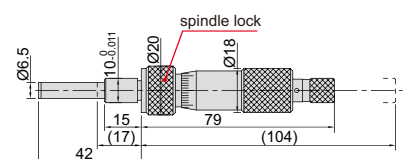

6381-25WP

Code	Range	Stem	Spindle tip	Remark	Accuracy
6381-25	0-25mm	with clamp nut	flat (carbide)		3µm
6381-25W	0-25mm	plain	flat (carbide)		3µm
6381-25S	0-25mm	with clamp nut	spherical (SR5)		3µm
6381-25WS	0-25mm	plain	spherical (SR5)		3µm
6381-25P	0-25mm	with clamp nut	flat (carbide)	with spindle lock	3µm
6381-25WP	0-25mm	plain	flat (carbide)	with spindle lock	3µm

- Meet DIN863-2
- Graduation 0.01mm
- Ratchet stop

NON-ROTATING SPINDLE MICROMETER HEAD



6377-25W

- Meet DIN863-2
- Graduation 0.01mm
- Ratchet stop
- Non-rotating spindle

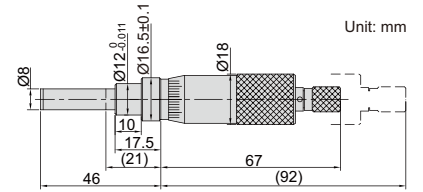

Code	Range	Stem	Spindle tip	Accuracy
6377-25W	0-25mm	plain	flat (carbide)	3µm

LARGE MICROMETER HEADS



6388-50AW

- Graduation 0.01mm
- Ratchet stop

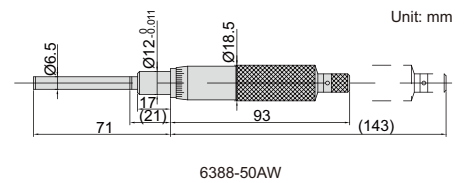
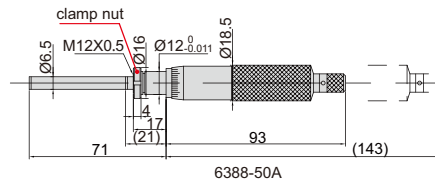

Code	Range	Stem	Spindle tip	Accuracy
6388-50A	0-50mm	with clamp nut	flat (carbide)	5µm
6388-50AW	0-50mm	plain	flat (carbide)	5µm

QUICK SPINDLE FEEDING MICROMETER HEADS



6375-50W



6375-25W



6375-15W

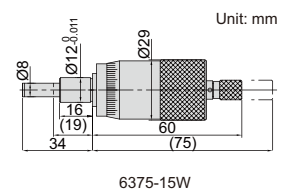
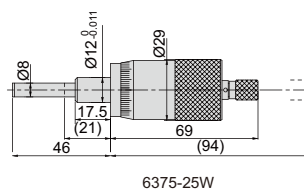
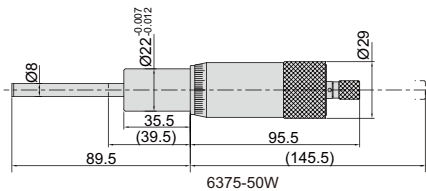

Code	Range	Stem	Spindle tip	Accuracy
6375-15W	0-15mm	plain	flat (carbide)	3µm
6375-25W	0-25mm	plain	flat (carbide)	3µm
6375-50W	0-50mm	plain	flat (carbide)	5µm

- Micrometers up to 25mm meet DIN863-2
- Graduation 0.01mm
- Quick spindle feed of 1mm/rev.
- Ratchet stop



PISTOL GRIP THREE POINTS BORE GAGES

- Optional accessory:
digital indicators (code **2103-10F**, resolution 0.001mm/0.00005")
or dial indicators (graduation 0.001mm),
setting rings (code **6312**)

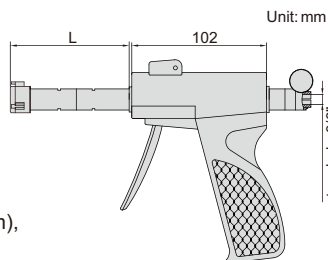

Unit: mm

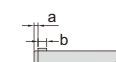

Type A
6-12mm, steel
measuring points



digital indicator
is not included

2124-8

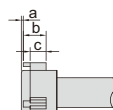

Type B
12-50mm, carbide
measuring points



digital indicator
is not included

2124-25

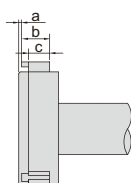

Type C
50-300mm, carbide
measuring points



digital indicator
is not included

2124-125

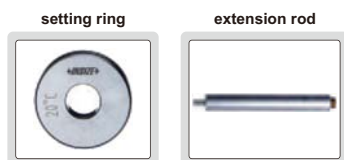

6-100mm: included
100-300mm: optional

included

interchangeable jaws

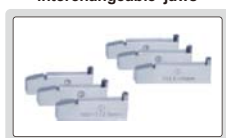

100-300mm: have two sets of jaws
for different measuring range
(For example, 2124-125 has
100-112.5mm and 112.5-125mm jaws)



Individual

Code	Range	Type	Accuracy (without digital indicator)	Setting ring	Extension rod (included)	L	a	b	c
2124-8*	6-8mm	A	4µm	Ø6mm (included)	100mm	50	1.5	2.5	—
2124-10*	8-10mm	A	4µm	Ø8mm (included)	100mm	50	1.5	2.5	—
2124-12*	10-12mm	A	4µm	Ø10mm (included)	100mm	50	1.5	2.5	—
2124-16*	12-16mm	B	4µm	Ø16mm (included)	150mm	65	0.5	6	4.5
2124-20*	16-20mm	B	4µm	Ø16mm (included)	150mm	65	0.5	6	4.5
2124-25*	20-25mm	B	4µm	Ø25mm (included)	150mm	91	0.5	8	6
2124-30*	25-30mm	B	4µm	Ø25mm (included)	150mm	91	0.5	8	6
2124-40*	30-40mm	B	4µm	Ø40mm (included)	150mm	97	0.5	14	12
2124-50*	40-50mm	B	5µm	Ø40mm (included)	150mm	97	0.5	14	12
2124-63*	50-63mm	C	5µm	Ø62mm (included)	150mm	112	0.5	17.5	14.5
2124-75*	62-75mm	C	5µm	Ø62mm (included)	150mm	112	0.5	17.5	14.5
2124-88*	75-88mm	C	5µm	Ø87mm (included)	150mm	112	0.5	17.5	14.5
2124-100*	87-100mm	C	5µm	Ø87mm (included)	150mm	112	0.5	17.5	14.5
2124-125*	100-125mm	C	5µm	Ø112.5mm (optional)	150mm	130	0.5	19.5	14.5
2124-150*	125-150mm	C	5µm	Ø137.5mm (optional)	150mm	130	0.5	19.5	14.5
2124-175*	150-175mm	C	5µm	Ø162.5mm (optional)	150mm	130	0.5	19.5	14.5
2124-200*	175-200mm	C	5µm	Ø187.5mm (optional)	150mm	130	0.5	19.5	14.5
2124-225	200-225mm	C	7µm	Ø212.5mm (optional)	150mm	130	0.5	19.5	14.5
2124-250	225-250mm	C	7µm	Ø237.5mm (optional)	150mm	130	0.5	19.5	14.5
2124-275	250-275mm	C	7µm	Ø262.5mm (optional)	150mm	130	0.5	19.5	14.5
2124-300	275-300mm	C	7µm	Ø287.5mm (optional)	150mm	130	0.5	19.5	14.5

Set

Code	Range	Probes included	Setting ring (included)	Extension rod (included)
2124-S123*	6-12mm	6-8mm, 8-10mm, 10-12mm	Ø6mm, Ø8mm, Ø10mm	100mm
2124-S202*	12-20mm	12-16mm, 16-20mm	Ø16mm	150mm
2124-S504*	20-50mm	20-25mm, 25-30mm, 30-40mm, 40-50mm	Ø25mm, Ø40mm	150mm
2124-S1004*	50-100mm	50-63mm, 62-75mm, 75-88mm, 87-100mm	Ø62mm, Ø87mm	150mm



2124-S504

* Supplied with manufacturer inspection certificate

THREE POINTS INTERNAL MICROMETERS

**INSPECTION
CERTIFICATE**

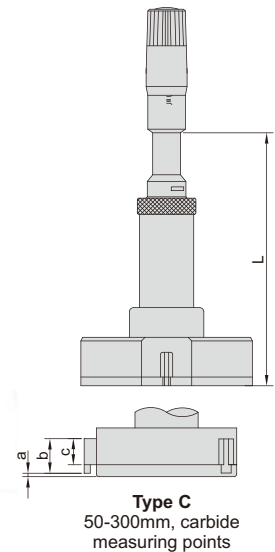
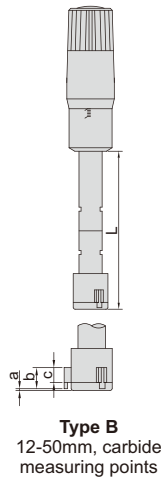
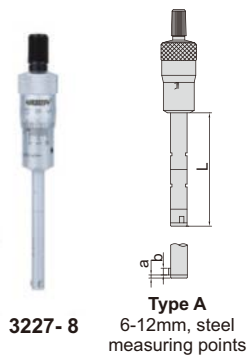

- Meet DIN863-4
- 6-12mm: graduation 0.001mm
12-300mm: graduation 0.005mm
- Ratchet stop
- Optional accessory: setting rings (code **6312**), micrometer stand and clamp (code **6301** and **6301-2**)



Individual

Code	Range	Type	Accuracy	Setting ring	Extension rod (included)	L	a	b	c
3227-8*	6-8mm	A	4µm	Ø6mm (included)	100mm	54.5	1.5	2.5	—
3227-10*	8-10mm	A	4µm	Ø8mm (included)	100mm	54.5	1.5	2.5	—
3227-12*	10-12mm	A	4µm	Ø10mm (included)	100mm	54.5	1.5	2.5	—
3227-16*	12-16mm	B	4µm	Ø16mm (included)	150mm	80	0.5	6	4.5
3227-20*	16-20mm	B	4µm	Ø16mm (included)	150mm	80	0.5	6	4.5
3227-25*	20-25mm	B	4µm	Ø25mm (included)	150mm	90	0.5	8	6
3227-30*	25-30mm	B	4µm	Ø25mm (included)	150mm	90	0.5	8	6
3227-40*	30-40mm	B	4µm	Ø40mm (included)	150mm	97	0.5	14	12
3227-50*	40-50mm	B	5µm	Ø40mm (included)	150mm	97	0.5	14	12
3227-63*	50-63mm	C	5µm	Ø62mm (included)	150mm	114	0.5	17.5	14.5
3227-75*	62-75mm	C	5µm	Ø62mm (included)	150mm	114	0.5	17.5	14.5
3227-88*	75-88mm	C	5µm	Ø87mm (included)	150mm	114	0.5	17.5	14.5
3227-100*	87-100mm	C	5µm	Ø87mm (included)	150mm	114	0.5	17.5	14.5
3227-125*	100-125mm	C	5µm	Ø112.5mm (optional)	150mm	145	0.5	19.5	14.5
3227-150*	125-150mm	C	5µm	Ø137.5mm (optional)	150mm	145	0.5	19.5	14.5
3227-175*	150-175mm	C	5µm	Ø162.5mm (optional)	150mm	145	0.5	19.5	14.5
3227-200*	175-200mm	C	5µm	Ø187.5mm (optional)	150mm	145	0.5	19.5	14.5
3227-225	200-225mm	C	7µm	Ø212.5mm (optional)	150mm	145	0.5	19.5	14.5
3227-250	225-250mm	C	7µm	Ø237.5mm (optional)	150mm	145	0.5	19.5	14.5
3227-275	250-275mm	C	7µm	Ø262.5mm (optional)	150mm	145	0.5	19.5	14.5
3227-300	275-300mm	C	7µm	Ø287.5mm (optional)	150mm	145	0.5	19.5	14.5

(mm)

setting ring



6-100mm: included
100-300mm: optional

extension rod



included

interchangeable jaws

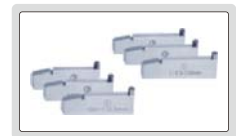

100-300mm: have two sets of jaws for different measuring range (For example, 3227-125 has 100-112.5mm and 112.5-125mm jaws)

Set

Code	Range	Micrometers included	Setting ring (included)	Extension rod (included)
3227-123*	6-12mm	6-8mm, 8-10mm, 10-12mm	Ø6mm, Ø8mm, Ø10mm	100mm
3227-202*	12-20mm	12-16mm, 16-20mm	Ø16mm	150mm
3227-504*	20-50mm	20-25mm, 25-30mm, 30-40mm, 40-50mm	Ø25mm, Ø40mm	150mm
3227-1004*	50-100mm	50-63mm, 62-75mm, 75-88mm, 87-100mm	Ø62mm, Ø87mm	150mm

* Supplied with manufacturer inspection certificate



3227-504



IP54
WATERPROOF

DATA
OUTPUT

DIGITAL THREE POINTS INTERNAL MICROMETERS



3127-12

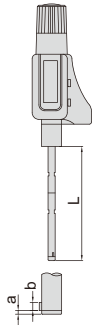

Type A
6-12mm, steel
measuring points



3127-40

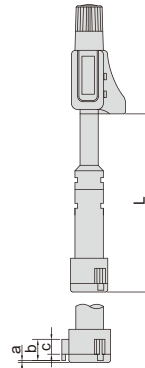

Type B
12-50mm, carbide
measuring points



3127-125

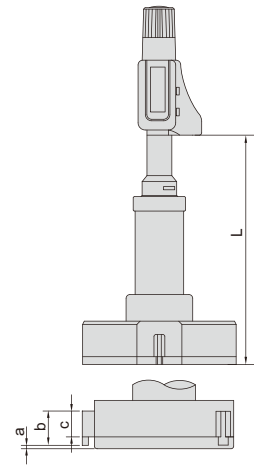

Type C
50-300mm, carbide
measuring points

- Meet DIN863-4
- Resolution 0.001mm/0.00005"
- IP54 dust/waterproof
- Buttons: on/off, set, mm/inch, ABS/INC
- Data output
- LR44 battery, automatic power off
- Ratchet stop
- Optional accessory: data output cable (code **7306-30A**, **7302-SPC6**, **7305-SPC3A**), setting ring (code **6312**), micrometer stand and clamp (code **6301** and **6301-2**)



setting ring



6-100mm: included
100-300mm: optional

extension rod

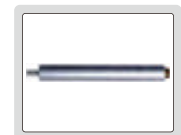

included

interchangeable jaws

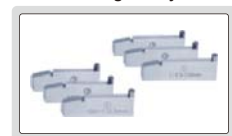

100-300mm: have two sets of jaws for different measuring range (For example, 3227-125 has 100-112.5mm and 112.5-125mm jaws)

Individual

(mm)

Code	Range	Type	Accuracy	Setting ring	Extension rod (included)	L	a	b	c
3127-8*	6-8mm/0.24-0.31"	A	4µm	Ø6mm (included)	100mm	54.5	1.5	2.5	—
3127-10*	8-10mm/0.31-0.39"	A	4µm	Ø8mm (included)	100mm	54.5	1.5	2.5	—
3127-12*	10-12mm/0.39-0.47"	A	4µm	Ø10mm (included)	100mm	54.5	1.5	2.5	—
3127-16*	12-16mm/0.47-0.63"	B	4µm	Ø16mm (included)	150mm	80	0.5	6	4.5
3127-20*	16-20mm/0.63-0.79"	B	4µm	Ø16mm (included)	150mm	80	0.5	6	4.5
3127-25*	20-25mm/0.79-0.98"	B	4µm	Ø25mm (included)	150mm	90	0.5	8	6
3127-30*	25-30mm/0.98-1.18"	B	4µm	Ø25mm (included)	150mm	90	0.5	8	6
3127-40*	30-40mm/1.18-1.57"	B	4µm	Ø40mm (included)	150mm	97	0.5	14	12
3127-50*	40-50mm/1.57-1.97"	B	5µm	Ø40mm (included)	150mm	97	0.5	14	12
3127-63*	50-63mm/1.97-2.48"	C	5µm	Ø62mm (included)	150mm	114	0.5	17.5	14.5
3127-75*	62-75mm/2.44-2.95"	C	5µm	Ø62mm (included)	150mm	114	0.5	17.5	14.5
3127-88*	75-88mm/2.95-3.46"	C	5µm	Ø87mm (included)	150mm	114	0.5	17.5	14.5
3127-100*	87-100mm/3.43-3.94"	C	5µm	Ø87mm (included)	150mm	114	0.5	17.5	14.5
3127-125*	100-125mm/3.94-4.92"	C	5µm	Ø112.5mm (optional)	150mm	150	0.5	19.5	14.5
3127-150*	125-150mm/4.92-5.91"	C	5µm	Ø137.5mm (optional)	150mm	150	0.5	19.5	14.5
3127-175*	150-175mm/5.91-6.89"	C	5µm	Ø162.5mm (optional)	150mm	150	0.5	19.5	14.5
3127-200*	175-200mm/6.89-7.87"	C	5µm	Ø187.5mm (optional)	150mm	150	0.5	19.5	14.5
3127-225*	200-225mm/7.87-8.86"	C	7µm	Ø212.5mm (optional)	150mm	150	0.5	19.5	14.5
3127-250*	225-250mm/8.86-9.84"	C	7µm	Ø237.5mm (optional)	150mm	150	0.5	19.5	14.5
3127-275*	250-275mm/9.84-10.83"	C	7µm	Ø262.5mm (optional)	150mm	150	0.5	19.5	14.5
3127-300*	275-300mm/10.83-11.81"	C	7µm	Ø287.5mm (optional)	150mm	150	0.5	19.5	14.5

Set

Code	Range	Micrometers included	Setting ring (included)	Extension rod (included)
3127-123*	6-12mm/0.24-0.47"	6-8mm, 8-10mm, 10-12mm	Ø6mm, Ø8mm, Ø10mm	100mm
3127-202*	12-20mm/0.47-0.79"	12-16mm, 16-20mm	Ø16mm	150mm
3127-504*	20-50mm/0.79-1.97"	20-25mm, 25-30mm, 30-40mm, 40-50mm	Ø25mm, Ø40mm	150mm
3127-1004*	50-100mm/1.97-3.94"	50-63mm, 62-75mm, 75-88mm, 87-100mm	Ø62mm, Ø87mm	150mm

* Supplied with manufacturer inspection certificate



3127-504

WIDE RANGE THREE POINTS INTERNAL MICROMETERS

- Meet DIN863-4
- Graduation 0.001mm
- Carbide measuring faces
- Ratchet stop
- Setting rings are included (except 200-300mm)

**INSPECTION
CERTIFICATE**

Code	Range	Accuracy	Setting ring
3228-70*	50-70mm	5µm	Ø50mm (included)
3228-100*	70-100mm	5µm	Ø70mm (included)
3228-150*	100-150mm	6µm	Ø100mm (included)
3228-250*	150-250mm	8µm	Ø150mm (included)
3228-300*	200-300mm	9µm	Ø200mm (optional)

* Supplied with manufacturer inspection certificate



3228-70

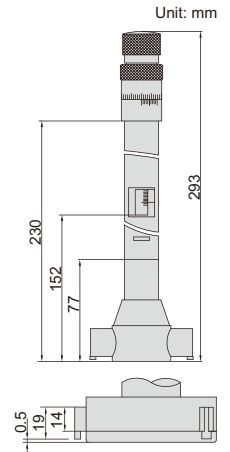

DIGITAL WIDE RANGE THREE POINTS INTERNAL MICROMETERS

**IP54
WATERPROOF**

**DATA
OUTPUT**

**INSPECTION
CERTIFICATE**

- Meet DIN863-4
- Resolution 0.001mm/0.00005"
- IP54 dust/waterproof
- Buttons: on/off, set, mm/inch, ABS/INC
- Data output
- LR44 battery, automatic power off
- Carbide measuring faces
- Ratchet stop
- Supplied with extension rods
- Setting rings are included (except 200-300mm)
- Optional accessory: data output cable (code 7306-30A, 7302-SPC6, 7305-SPC3A)



3128-70

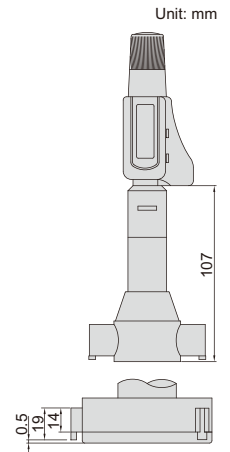

Code	Range	Accuracy	Setting ring	Extension rod (included)
3128-70*	50-70mm/1.97-2.76"	5µm	Ø50mm (included)	150mm
3128-100*	70-100mm/2.76-3.94"	5µm	Ø70mm (included)	150mm
3128-150*	100-150mm/3.94-5.91"	6µm	Ø100mm (included)	150mm
3128-250*	150-250mm/5.91-9.84"	8µm	Ø150mm (included)	150mm
3128-300*	200-300mm/7.87-11.81"	9µm	Ø200mm (optional)	150mm

* Supplied with manufacturer inspection certificate

INSIDE MICROMETERS

- Graduation 0.01mm
- Ratchet stop
- Carbide measuring faces
- Optional accessory: setting ring (code 6312), micrometer stand and clamp (code 6301 and 6301-1)



Unit: mm

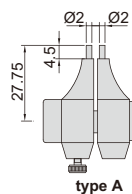

3220-50

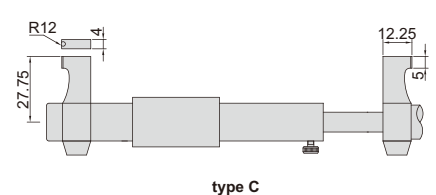
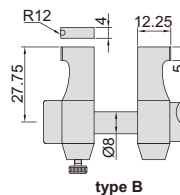

Code	Range	Type	Setting ring	Accuracy
3220-30	5-30mm	A	5mm (included)	7µm
3220-50	25-50mm	B	25mm (included)	8µm
3220-75	50-75mm	B	50mm (optional)	9µm
3220-100	75-100mm	C	75mm (optional)	10µm

DATA
OUTPUT

DIGITAL INSIDE MICROMETERS

- Resolution 0.001mm/0.00005"
- Button function: on/off, set, mm/inch, ABS/INC, data output
- Data output
- LR44 battery, automatic power off
- Ratchet stop
- Carbide measuring faces
- Optional accessory: data output cable (code **7306-30**, **7302-SPC2A**, **7305-SPC3**), setting ring (code **6312**)



3520-30

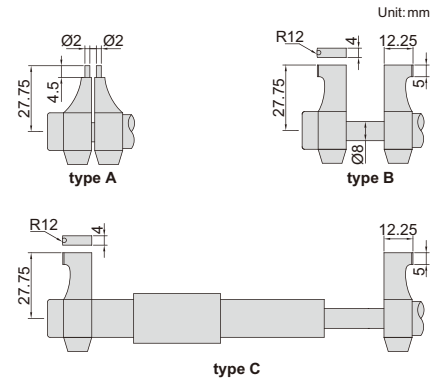

Code	Range	Type	Setting ring	Accuracy
3520-30	5-30mm/0.2-1.2"	A	5mm (included)	±5μm
3520-50	25-50mm/1-2"	B	25mm (included)	±6μm
3520-75	50-75mm/2-3"	B	50mm (optional)	±7μm
3520-100	75-100mm/3-4"	C	75mm (optional)	±8μm



INTERNAL SCREW THREAD MICROMETERS

- Measure pitch diameter of screw thread
- Graduation 0.01mm
- Ratchet stop
- Optional accessory: measuring tips for internal screw thread micrometer (code **7385**)

tips are not included



3640-45

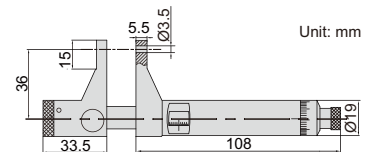

Code	Range	Accuracy	Applicable tips
3640-45	20-45mm	4μm	stem length L=5mm
3640-70	45-70mm	5μm	stem length L=5mm
3640-95	70-95mm	5μm	stem length L=13.5mm
3640-120	95-120mm	6μm	stem length L=13.5mm

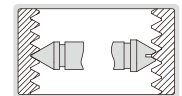

RELATIVE PRODUCT:
GEAR BORE GAGE (CODE 2428)



INTERNAL GEAR TOOTH MICROMETERS

- Measure over-pin diameter of gears
- Graduation 0.01mm
- Ratchet stop
- Optional accessory: ball tips (code **7383**)

before ball tips
are installed



3637-50

ball tips are not included

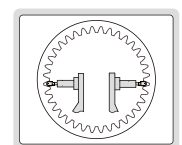
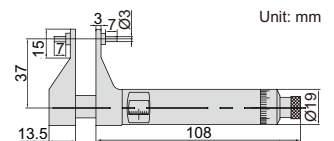

Code	Range	Accuracy
3637-50	25-50mm	4μm
3637-75	50-75mm	5μm

TUBULAR INSIDE MICROMETERS

- Micrometers up to 500mm meet DIN863-4
- Graduation 0.01mm
- Carbide measuring faces

Code	Range	Type	Accuracy
3229-75	50-75mm	A	5µm
3229-100	75-100mm	B	5µm
3229-125	100-125mm	C	6µm
3229-150	125-150mm	C	6µm
3229-175	150-175mm	C	7µm
3229-200	175-200mm	C	7µm
3229-225	200-225mm	C	8µm
3229-250	225-250mm	C	8µm
3229-275	250-275mm	C	9µm
3229-300	275-300mm	C	9µm
3229-325	300-325mm	C	9µm
3229-350	325-350mm	C	9µm
3229-375	350-375mm	C	10µm
3229-400	375-400mm	C	10µm
3229-425	400-425mm	C	10µm
3229-450	425-450mm	C	10µm
3229-475	450-475mm	C	11µm
3229-500	475-500mm	C	11µm
3229-525	500-525mm	C	11µm
3229-550	525-550mm	C	11µm
3229-575	550-575mm	C	11µm
3229-600	575-600mm	C	12µm
3229-625	600-625mm	C	12µm
3229-650	625-650mm	C	12µm
3229-675	650-675mm	C	13µm
3229-700	675-700mm	C	13µm
3229-725	700-725mm	C	13µm
3229-750	725-750mm	C	14µm
3229-775	750-775mm	C	14µm
3229-800	775-800mm	C	14µm



3229-225

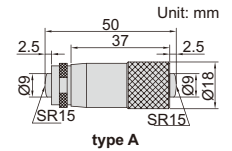

type A

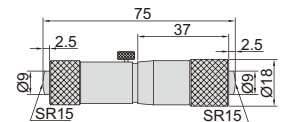

type B

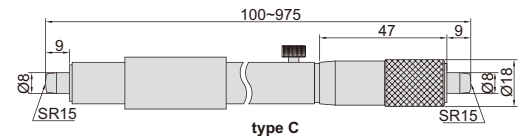

type C

Code	Range	Type	Accuracy
3229-825	800-825mm	C	15µm
3229-850	825-850mm	C	15µm
3229-875	850-875mm	C	15µm
3229-900	875-900mm	C	16µm
3229-925	900-925mm	C	16µm
3229-950	925-950mm	C	16µm
3229-975	950-975mm	C	17µm
3229-1000	975-1000mm	C	17µm

TUBULAR INSIDE MICROMETERS

- Graduation 0.01mm
- Accuracy: $(6+L/50)\mu\text{m}$
L=maximum measuring length (mm)
- Optional accessory: setting ring (code 6312)



3221-200

Code	Range	Travel of micrometer head	Extension rods
3221-32	25-32mm	7mm	—
3221-50	25-50mm	7mm	2pcs
3221-63	50-63mm	13mm	—
3221-200	50-200mm	13mm	6pcs
3221-300	50-300mm	13mm	10pcs
3221-225	200-225mm	25mm	—
3221-500	200-500mm	25mm	3pcs
3221-1000	200-1000mm	25mm	8pcs

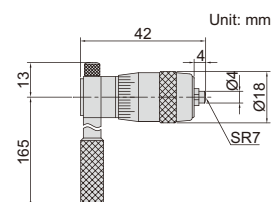

TUBULAR INSIDE MICROMETERS

- Graduation 0.01mm
- Accuracy: $(3+n+L/50)\mu\text{m}$
n=number of rods
L=maximum measuring length (mm)
- Supplied with setting standards
- Carbide measuring faces



3222-150

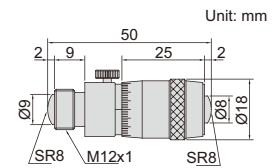

Code	Range	Travel of micrometer head	Extension rods
3222-63	50-63mm	13mm	—
3222-150	50-150mm	13mm	13mm, 25mm, 50mm
3222-300	50-300mm	13mm	13mm, 25mm, 50mm (2pcs), 100mm
3222-500	50-500mm	13mm	13mm, 25mm, 50mm (2pcs), 100mm, 200mm
3222-600	50-600mm	13mm	13mm, 25mm, 50mm, 100mm, 150mm, 200mm
3222-1000	50-1000mm	13mm	13mm, 25mm, 50mm (2pcs), 100mm, 200mm (2pcs), 300mm
3222-1500	50-1500mm	13mm	13mm, 25mm, 50mm (2pcs), 100mm, 200mm (3pcs), 300mm (2pcs)

TUBULAR INSIDE MICROMETERS

- Graduation 0.01mm
- Accuracy: $(3+n+L/50)\mu\text{m}$
n=number of rods
L=maximum measuring length (mm)
- Travel of micrometer head 25mm
- Supplied with setting standards
- Carbide measuring faces

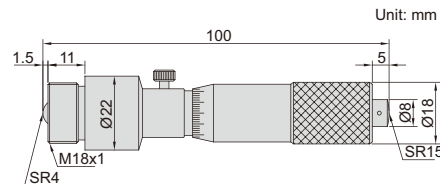

3225-500

Code	Range	Extension rods
3225-125	100-125mm	—
3225-500	100-500mm	25mm, 50mm, 100mm, 200mm
3225-900	100-900mm	25mm, 50mm, 100mm, 200mm, 400mm
3225-1300	100-1300mm	25mm, 50mm, 100mm, 200mm, 400mm (2pcs)
3225-1700	100-1700mm	25mm, 50mm, 100mm, 200mm, 400mm (3pcs)
3225-2100	100-2100mm	25mm, 50mm, 100mm, 200mm, 400mm (4pcs)

TUBULAR INSIDE MICROMETERS



3224-2000

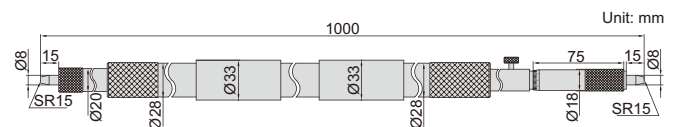

Code	Range	Extension rods
3224-2000	1000-2000mm	50mm, 100mm (2pcs), 200mm, 500mm
3224-3000	1000-3000mm	50mm, 100mm (2pcs), 200mm, 500mm, 1000mm
3224-4000	1000-4000mm	50mm, 100mm (2pcs), 200mm, 500mm, 1000mm (2pcs)
3224-5000	1000-5000mm	50mm, 100mm (2pcs), 200mm, 500mm, 1000mm (3pcs)

- Graduation 0.01mm
- Accuracy: $(7+n+L/50)\mu\text{m}$
n=number of rods
L=maximum measuring length (mm)
- Travel of micrometer head 50mm
- Carbide measuring faces

DIGITAL NON-ROTATING SPINDLE TUBULAR INSIDE MICROMETERS



NON-ROTATING SPINDLE

DATA OUTPUT

SPRING LOADED MEASURING POINT



3635-950

- Micrometer head: 150-175mm
- Carbide measuring faces for micrometer head and extension rods
- Points of extension rods are spring loaded
- Data output
- Button function: mm/inch, max./min. value tracking, tolerance measurement, hold, on/off, zero
- CR2032 battery, automatic power off

Code	Range	Extension rods
3635-350	150-350mm	25mm, 50mm, 100mm
3635-550	150-550mm	25mm, 50mm, 100mm, 200mm
3635-950	150-950mm	25mm, 50mm, 100mm, 200mm, 400mm
3635-1550	150-1550mm	25mm, 50mm, 100mm, 200mm(2pcs), 400mm(2pcs)
3635-2150	150-2150mm	25mm, 50mm, 100mm, 200mm, 400mm(4pcs)
3635-3150	150-3150mm	25mm, 50mm, 100mm, 200mm(2pcs), 400mm, 1000mm(2pcs)
3635-4150	150-4150mm	25mm, 50mm, 100mm, 200mm(2pcs), 400mm, 1000mm(3pcs)
3635-5150	150-5150mm	25mm, 50mm, 100mm, 200mm(2pcs), 400mm, 1000mm(4pcs)
3635-6150	150-6150mm	25mm, 50mm, 100mm, 200mm(2pcs), 400mm, 1000mm(5pcs)

Micrometer head

Range	Resolution	Accuracy	Repeatability	Measuring force	Weight
150-175mm	0.001mm/0.00005" 0.01mm/0.0005" (switchable)	±4µm	1µm	5-10N	275g

1m carbon fiber extension rod, light weight, no deform

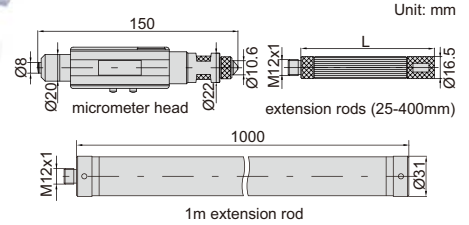
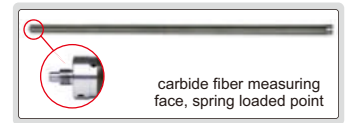

non-rotating spindle, spring loaded point and max./min. value tracking make it easy to find the right measuring position

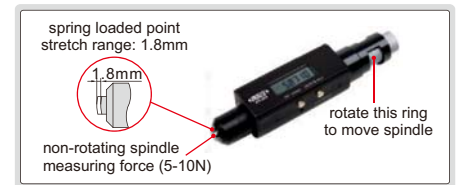

Extension rods

Length (L)	Accuracy	Weight	Material
25mm	±1.25µm	37g	steel
50mm	±1.25µm	65g	steel
100mm	±2µm	113g	steel
200mm	±3.5µm	208g	steel
400mm	±4.5µm	402g	steel
1000mm	±7.5µm	909g	carbon fiber

TUBULAR INSIDE MICROMETERS



3634-1300

- Micrometer head: 100-125mm
- Carbide measuring faces for micrometer head and extension rods
- Points of extension rods are spring loaded

Code	Range	Extension rods
3634-350	100-350mm	25mm, 200mm
3634-500	100-500mm	25mm, 50mm, 100mm, 200mm
3634-1300	100-1300mm	25mm, 50mm, 100mm, 200mm, 400mm (2pcs)
3634-1500	100-1500mm	25mm, 50mm, 100mm, 200mm (2pcs), 400mm (2pcs)
3634-2100	100-2100mm	25mm, 50mm, 100mm, 200mm, 400mm (4pcs)
3634-3100	100-3100mm	25mm, 50mm, 100mm, 200mm (2pcs), 400mm, 1000mm (2pcs)
3634-4100	100-4100mm	25mm, 50mm, 100mm, 200mm (2pcs), 400mm, 1000mm (3pcs)
3634-5100	100-5100mm	25mm, 50mm, 100mm, 200mm (2pcs), 400mm, 1000mm (4pcs)
3634-6100	100-6100mm	25mm, 50mm, 100mm, 200mm (2pcs), 400mm, 1000mm (5pcs)

1m carbon fiber extension rod, light weight, no deform

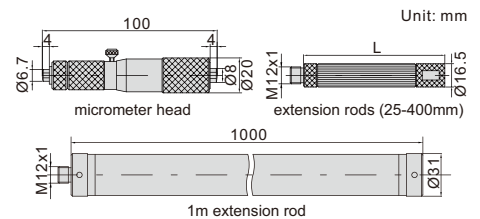
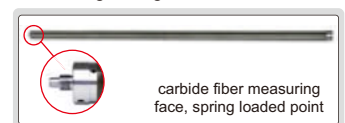

Micrometer head

Range	Graduation	Accuracy	Weight
100-125mm	0.01mm	±4µm	154g

Extension rods

Length (L)	Accuracy	Weight	Material
25mm	±1.25µm	37g	steel
50mm	±1.25µm	65g	steel
100mm	±2µm	113g	steel
200mm	±3.5µm	208g	steel
400mm	±4.5µm	402g	steel
1000mm	±7.5µm	909g	carbon fiber



RELATIVE PRODUCT:
GEAR BORE GAGE (CODE 2428)

INTERNAL GEAR TOOTH MICROMETERS

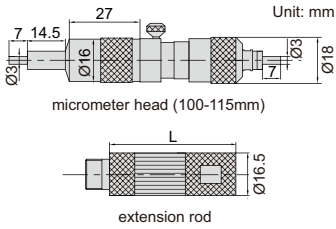

3638-200

- Measure over-pin diameter of gears
- Points of extension rods are spring loaded
- Optional accessory: ball tips (code 7383)

Micrometer head

Range	Graduation	Accuracy
100-115mm	0.01mm	±4µm
150-175mm	0.01mm	±4µm

Extension rod

Length (L)	Accuracy
15mm	±1µm
25mm	±1.25µm
30mm	±1.25µm
50mm	±1.25µm
100mm	±2µm
200mm	±3.5µm
400mm	±4.5µm

Code	Range	Micrometer head	Extension rod (L)
3638-200	100-205mm	100-115mm	15, 25, 30
3638-500	100-505mm	100-115mm	15, 25, 50, 100, 200
3638-900	100-905mm	100-115mm	15, 25, 50, 100, 200, 400
3638-1100	150-1150mm	150-175mm	25, 50, 100, 200, 200, 400

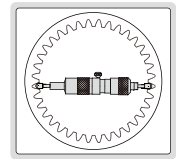

INTERNAL SCREW THREAD MICROMETERS

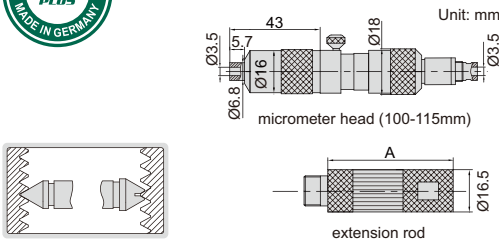

3641-200

- Measure pitch diameter of screw thread
- Points of extension rods are spring loaded
- Optional accessory: measuring tips for internal screw thread micrometer (code 7385)

Micrometer head

Range	Graduation	Accuracy
100-115mm	0.01mm	±4µm
150-175mm	0.01mm	±4µm

Extension rod

Length (A)	Accuracy
15mm	±1µm
25mm	±1.25µm
50mm	±1.25µm
100mm	±2µm
200mm	±3.5µm
400mm	±4.5µm

Code	Range	Micrometer head	Extension rod (A)	Applicable tips
3641-200	100-205mm	100-115mm	15, 25, 50	stem length L=13.5mm
3641-500	100-505mm	100-115mm	15, 25, 50, 100, 200	stem length L=13.5mm
3641-900	100-905mm	100-115mm	15, 25, 50, 100, 200, 400	stem length L=13.5mm
3641-1100	150-1150mm	150-175mm	25, 50, 100, 200, 200, 400	stem length L=13.5mm

INTERNAL SCREW THREAD MICROMETERS

- Graduation: 0.01mm
- Optional accessory: measuring tips for internal screw thread micrometer (code 7321), zero block (code 3226-SP)

Code	Range	Zero Block (optional)
3226-1001	75-100mm	100mm (code 3226-SP100)
3226-1251	100-125mm	100mm (code 3226-SP100)
3226-1501	125-150mm	150mm (code 3226-SP150)
3226-1751	150-175mm	150mm (code 3226-SP150)
3226-2001	175-200mm	200mm (code 3226-SP200)
3226-2251	200-225mm	200mm (code 3226-SP200)
3226-2501	225-250mm	250mm (code 3226-SP250)
3226-2751	250-275mm	250mm (code 3226-SP250)
3226-3001	275-300mm	300mm (code 3226-SP300)



3226-1001

zero block (optional)

measuring tips for internal screw thread micrometer (optional)



MEASURING TIPS FOR INTERNAL SCREW THREAD MICROMETERS

- Supplied in pair
- Suitable for 3226 series micrometers

Metric and unified screw (60° thread angle)

Code	Pitch
7321-T11	0.4-0.5mm/64-48TPI
7321-T12	0.6-0.9mm/44-28TPI
7321-T13	1-1.75mm/24-14TPI
7321-T14	2-3mm/13-9TPI
7321-T15	3.5-5mm/8-5TPI
7321-T16	5.5-7mm /4.5-3.5TPI
7321-T1S	6 pairs/set, including all above tips



7321-T1S

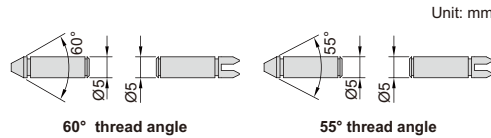

Whitworth screw (55° thread angle)

Code	Pitch
7321-T21	60-48TPI
7321-T22	48-40TPI
7321-T23	40-32TPI
7321-T24	32-24TPI
7321-T25	24-18TPI
7321-T26	18-14TPI
7321-T27	14-10TPI
7321-T28	10-7TPI
7321-T29	7-4.5TPI
7321-T210	4.5-3.5TPI
7321-T2S	10 pairs/set, including all above tips

BORE PLUG GAGES



principle of measurement

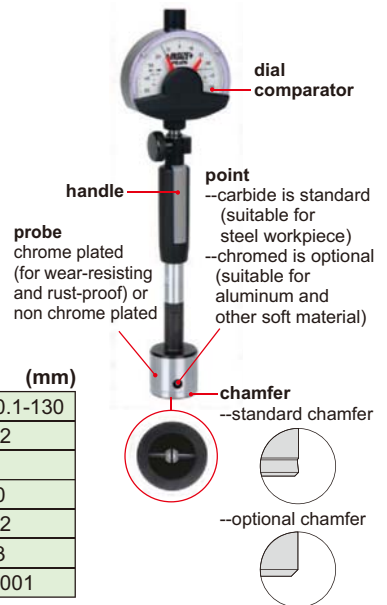
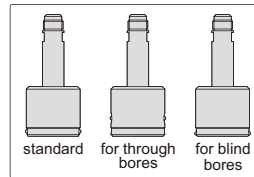
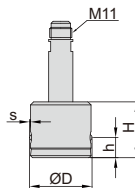
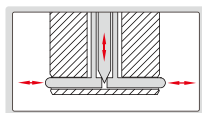

SPECIFICATION OF PROBE

	(mm)									
Range	2-3	3.1-4	4.1-6	6.1-9	9.1-12	12.1-20	20.1-40	40.1-60	60.1-130	
Travel of point (s)	0.15	0.15	0.15	0.2	0.2	0.2	0.2	0.2	0.2	
Height of point (h)	standard	1	1.5	1.5	2.5	2.5	2.5	3.5	3.5	4
	for through bores	—	6	6	6	10	10	10	10	10
for blind bores	0.7	1	1	1	1	1	1.2	1.2	1.2	
Height of probe (H)	17.5	26	10	15	15	15	20	28	33	
Repeatability	0.001	0.001	0.001	0.0005	0.0005	0.0005	0.0005	0.0005	0.001	

PROBE

Code	Type
4653-A□□□□	standard, non chrome plated
4653-B□□□□	for through bores, non chrome plated
4653-C□□□□	for blind bores, non chrome plated
4653-D□□□□	standard, chrome plated
4653-E□□□□	for through bores, chrome plated
4653-F□□□□	for blind bores, chrome plated



HANDLE

Code	Length (L)	Retraction
4653-150	45	without
4653-1105	105	without
4653-1235	235	without
4653-H70	70	with



Ordering examples:

Code	Type	Range (mm)
4653-A30D6H7 *	standard, non chrome plated	30.6H7
4653-E18D2H8 *	for through bores, chrome plated	18.2H8

* "D" stands for "."

DEPTH STOP

Code	Applicable for probe
4653-G□□□□	3.0-60mm

Ordering example:

Code	Applicable for probe (mm)
4653-G22H7	22H7



EXTENSION ROD FOR HANDLE

Code	Length (H)
4653-R50	50mm
4653-R100	100mm
4653-R250	250mm
4653-R500	500mm

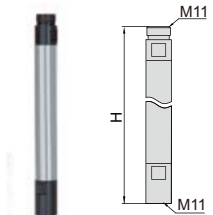

SETTING RING

Code
6312-□□□□□





INTERNAL SPLINE PLUG GAGES

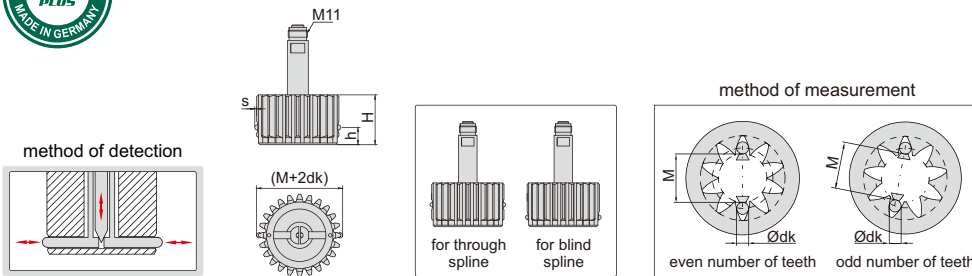

PROBE SPECIFICATION

(mm)

Range	8-15	12.1-20	20.1-40	40.1-60
Travel of point (s)	0.2	0.2	0.2	0.2
Height of point (h)	for through bores	6	10	10
	for blind bores	4	6	6
Height of sleeve (H)	for through bores	18.5	22.5	28
	for blind bores	16.5	18.5	24
Repeatability	0.002	0.002	0.002	0.002

PROBE

Code	Type
4655-A□□□□	for through spline
4655-B□□□□	for blind spline

Probe ordering examples:

Code	Type	Range
4655-A20D8 *	for through spline	20.8mm
4655-B16D6 *	for blind spline	16.6mm

* "D" stands for "."

HANDLE (OPTIONAL)

(mm)

Code	Length (L)	Retraction
4653-150	45	without
4653-1105	105	without
4653-1235	235	without
4653-H70	70	with

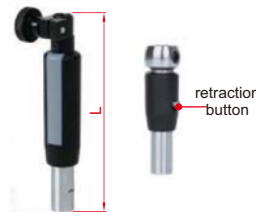

EXTENSION ROD FOR HANDLE (OPTIONAL)

Code	Length (H)
4653-R50	50
4653-R100	100
4653-R250	250
4653-R500	500

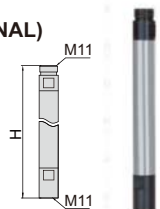

SETTING MASTER (OPTIONAL)

Code	Remark
4655-□□□□-SETTER	design according to probes



STAND FOR SPLIT DIAL BORE GAGES

- For split type dial bore gages 2421, 2426, 2427 and 2429
- Maximum working stroke: 90mm
- Accept dial indicator to show measuring depth

Code
2491-250

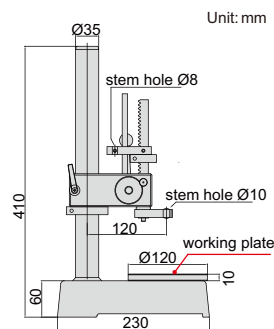

2491-250

SPLIT TYPE DIAL BORE GAGES

dial indicator
is not included



- Split type contact points
- Accuracy (without indicator):
3µm (measuring range 0.95–10mm),
4µm (measuring range 10–20.6mm)
- Repeatability (without indicator): 1µm

principle of measurement

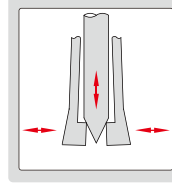

(mm)

Code	Contact point			Material	Measuring needle		Setting ring	
	Measuring range	Measuring depth (L1)	Total length (L)		Code	Code	Diameter	
2426-1	0.95-1.15	13	89	carbide tip	2426-N1D4	6312-R1	1	
2426-1D1	1.07-1.25	13	89	carbide tip		6312-R1D1	1.1	
2426-1D2	1.17-1.35	13	89	carbide tip		6312-R1D2	1.2	
2426-1D3	1.27-1.45	13	89	carbide tip		6312-R1D3	1.3	
2426-1D4	1.37-1.55	13	89	carbide tip		6312-R1D4	1.4	
2426-1D75	1.5-1.9	17	93	carbide tip	2426-N2D25	6312-1D75	1.75	
2426-2	1.8-2.2	17	93	carbide tip		6312-2	2	
2426-2D25	2.05-2.45	17	93	carbide tip		6312-2D25	2.25	
2426-2D5	2.3-2.7	25	101	carbide tip	2426-N4	6312-2D5	2.5	
2426-2D75	2.55-2.95	25	101	carbide tip		6312-2D75	2.75	
2426-3	2.8-3.2	25	101	carbide tip		6312-3	3	
2426-3D25	3.05-3.45	25	101	carbide tip		6312-3D25	3.25	
2426-3D5	3.3-3.7	25	101	carbide tip		6312-3D5	3.5	
2426-3D75	3.55-3.95	25	101	carbide tip		6312-3D75	3.75	
2426-4	3.8-4.2	25	101	carbide tip		6312-4	4	
2426-4D5	4.15-4.8	41	118	hard chromed	2426-N9	6312-4D5	4.5	
2426-5	4.7-5.3	41	118	hard chromed		6312-5	5	
2426-5D5	5.2-5.8	41	118	hard chromed		6312-5D5	5.5	
2426-6	5.7-6.3	41	118	hard chromed		6312-6	6	
2426-6D5	6.2-6.8	41	118	hard chromed		6312-6D5	6.5	
2426-7	6.7-7.3	41	118	hard chromed		6312-7	7	
2426-7D5	7.2-7.8	45	118	hard chromed		6312-7D5	7.5	
2426-8	7.7-8.3	45	118	hard chromed		6312-8	8	
2426-8D5	8.2-8.8	45	118	hard chromed		6312-8D5	8.5	
2426-9	8.7-9.3	45	118	hard chromed		6312-9	9	
2426-10	9.2-10.5	45	118	hard chromed		6312-10	10	
2426-11	10.2-11.5	45	118	hard chromed		6312-11	11	
2426-12	11.2-12.5	45	118	hard chromed	2426-N20	6312-12	12	
2426-13	12.2-13.5	45	118	hard chromed		6312-13	13	
2426-14	13.4-14.6	45	118	hard chromed		6312-14	14	
2426-15	14.4-15.6	45	118	hard chromed		6312-15	15	
2426-16	15.4-16.6	45	118	hard chromed		6312-16	16	
2426-17	16.4-17.6	45	118	hard chromed		6312-17	17	
2426-18	17.4-18.6	45	118	hard chromed		6312-18	18	
2426-19	18.4-19.6	45	118	hard chromed		6312-19	19	
2426-20	19.4-20.6	45	118	hard chromed		6312-20	20	

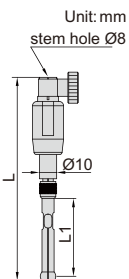
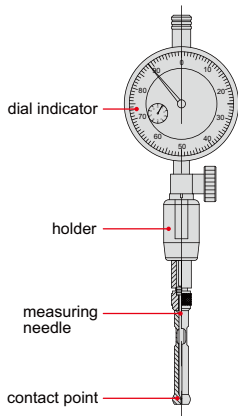

HOLDER

Code	Retraction	Applicable points
2426-HOLDER1	without	all
2426-HOLDER2	with	all



SPLIT TYPE DIAL BORE GAGE SETS

- Split type contact points
- Accuracy (without indicator): 3µm (measuring range 0.95~10mm), 4µm (measuring range 10~20.6mm)
- Repeatability (without indicator): 1µm
- Setting rings and dial indicators are optional

principle of measurement

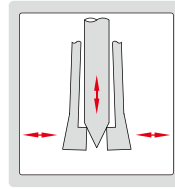

Code	Range	Quantity of points	Measuring range of point	Measuring depth (L1)	Total length (L)	Material	Type of point	Setting ring (optional)	
								Code	Diameter
2421-1D4	0.95-1.55	5	0.95-1.15	13	89	carbide tip	A	6312-R1	1
			1.07-1.25	13	89	carbide tip	A	6312-R1D1	1.1
			1.17-1.35	13	89	carbide tip	A	6312-R1D2	1.2
			1.27-1.45	13	89	carbide tip	A	6312-R1D3	1.3
			1.37-1.55	13	89	carbide tip	A	6312-R1D4	1.4
2421-4	1.5-4.2	10	1.5-1.9	17	93	carbide tip	A	6312-1D75	1.75
			1.8-2.2	17	93	carbide tip	A	6312-2	2
			2.05-2.45	17	93	carbide tip	A	6312-2D25	2.25
			2.3-2.7	25	101	carbide tip	A	6312-2D5	2.5
			2.55-2.95	25	101	carbide tip	A	6312-2D75	2.75
			2.8-3.2	25	101	carbide tip	A	6312-3	3
			3.05-3.45	25	101	carbide tip	A	6312-3D25	3.25
			3.3-3.7	25	101	carbide tip	A	6312-3D5	3.5
			3.55-3.95	25	101	carbide tip	A	6312-3D75	3.75
			3.8-4.2	25	101	carbide tip	A	6312-4	4
2421-7D5	4.15-7.8	7	4.15-4.8	41	118	hard chromed	B	6312-4D5	4.5
			4.7-5.3	41	118	hard chromed	B	6312-5	5
			5.2-5.8	41	118	hard chromed	B	6312-5D5	5.5
			5.7-6.3	41	118	hard chromed	B	6312-6	6
			6.2-6.8	41	118	hard chromed	B	6312-6D5	6.5
			6.7-7.3	41	118	hard chromed	B	6312-7	7
			7.2-7.8	45	118	hard chromed	C	6312-7D5	7.5
2421-12	7.7-12.5	6	7.7-8.3	45	118	hard chromed	C	6312-8	8
			8.2-8.8	45	118	hard chromed	C	6312-8D5	8.5
			8.7-9.3	45	118	hard chromed	C	6312-9	9
			9.2-10.5	45	118	hard chromed	C	6312-10	10
			10.2-11.5	45	118	hard chromed	C	6312-11	11
			11.2-12.5	45	118	hard chromed	C	6312-12	12
2421-20	12.2-20.6	8	12.2-13.5	45	118	hard chromed	C	6312-13	13
			13.4-14.6	45	118	hard chromed	C	6312-14	14
			14.4-15.6	45	118	hard chromed	C	6312-15	15
			15.4-16.6	45	118	hard chromed	C	6312-16	16
			16.4-17.6	45	118	hard chromed	C	6312-17	17
			17.4-18.6	45	118	hard chromed	C	6312-18	18
			18.4-19.6	45	118	hard chromed	C	6312-19	19
			19.4-20.6	45	118	hard chromed	C	6312-20	20
2421-121	4.15-12.5	13	4.15-4.8	41	118	hard chromed	B	6312-4D5	4.5
			4.7-5.3	41	118	hard chromed	B	6312-5	5
			5.2-5.8	41	118	hard chromed	B	6312-5D5	5.5
			5.7-6.3	41	118	hard chromed	B	6312-6	6
			6.2-6.8	41	118	hard chromed	B	6312-6D5	6.5
			6.7-7.3	41	118	hard chromed	B	6312-7	7
			7.2-7.8	45	118	hard chromed	C	6312-7D5	7.5
			7.7-8.3	45	118	hard chromed	C	6312-8	8
			8.2-8.8	45	118	hard chromed	C	6312-8D5	8.5
			8.7-9.3	45	118	hard chromed	C	6312-9	9
			9.2-10.5	45	118	hard chromed	C	6312-10	10
			10.2-11.5	45	118	hard chromed	C	6312-11	11
			11.2-12.5	45	118	hard chromed	C	6312-12	12

(mm)

2421-121

dial indicator is not included

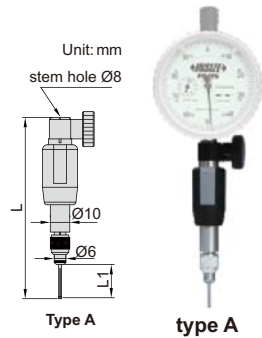

dial indicator is not included

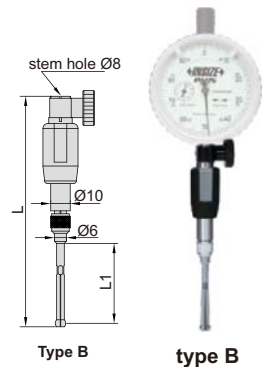

dial indicator is not included

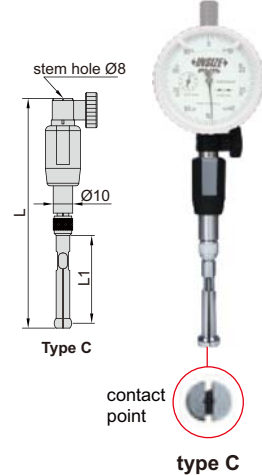

SPLIT TYPE DIAL BORE GAGES FOR BLIND HOLES

dial indicator
is not included



contact point

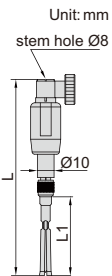
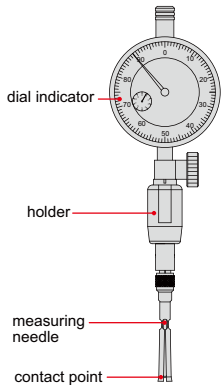

principle of measurement

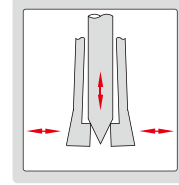

- Split type contact points
- Accuracy (without indicator):
3µm (measuring range 1.5~10mm),
4µm (measuring range 10~20.6mm)
- Repeatability (without indicator): 1µm

(mm)

Contact point				Measuring needle	Setting ring	
Code	Measuring range	Measuring depth (L1)	Total length (L)	Code	Code	Diameter
2427-1D75	1.5-1.9	17	93	2426-N2D25	6312-1D75	1.75
2427-2	1.8-2.2	17	93		6312-2	2
2427-2D25	2.05-2.45	17	93		6312-2D25	2.25
2427-2D5	2.3-2.7	25	101		6312-2D5	2.5
2427-2D75	2.55-2.95	25	101	2426-N4	6312-2D75	2.75
2427-3	2.8-3.2	25	101		6312-3	3
2427-3D25	3.05-3.45	25	101		6312-3D25	3.25
2427-3D5	3.3-3.7	25	101		6312-3D5	3.5
2427-3D75	3.55-3.95	25	101	2427-N9	6312-3D75	3.75
2427-4	3.8-4.2	25	101		6312-4	4
2427-4D5	4.15-4.8	41	118		6312-4D5	4.5
2427-5	4.7-5.3	41	118		6312-5	5
2427-5D5	5.2-5.8	41	118	2427-N9	6312-5D5	5.5
2427-6	5.7-6.3	41	118		6312-6	6
2427-6D5	6.2-6.8	41	118		6312-6D5	6.5
2427-7	6.7-7.3	41	118		6312-7	7
2427-7D5	7.2-7.8	45	118	2427-N20	6312-7D5	7.5
2427-8	7.7-8.3	45	118		6312-8	8
2427-8D5	8.2-8.8	45	118		6312-8D5	8.5
2427-9	8.7-9.3	45	118		6312-9	9
2427-10	9.2-10.5	45	118	2427-N20	6312-10	10
2427-11	10.2-11.5	45	118		6312-11	11
2427-12	11.2-12.5	45	118		6312-12	12
2427-13	12.2-13.5	45	118		6312-13	13
2427-14	13.4-14.6	45	118		6312-14	14
2427-15	14.4-15.6	45	118		6312-15	15
2427-16	15.4-16.6	45	118		6312-16	16
2427-17	16.4-17.6	45	118		6312-17	17
2427-18	17.4-18.6	45	118		6312-18	18
2427-19	18.4-19.6	45	118		6312-19	19
2427-20	19.4-20.6	45	118		6312-20	20



2426-HOLDER1



retraction
button

2426-HOLDER2

HOLDER

Code	Retraction	Applicable points
2426-HOLDER1	without	all
2426-HOLDER2	with	all



principle of measurement

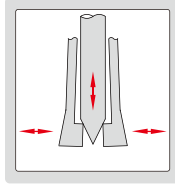

SPLIT TYPE DIAL BORE GAGE SETS FOR BLIND HOLES



2429-4

dial indicator is not included

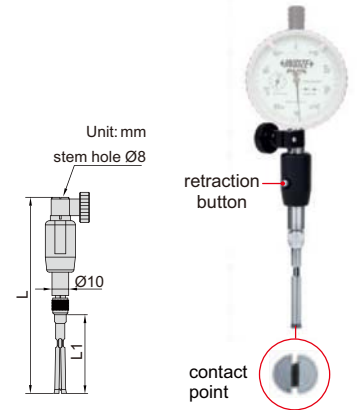

- Split type contact points
- Accuracy (without indicator): 3µm (measuring range 1.5~10mm), 4µm (measuring range 10~20.6mm)
- Repeatability (without indicator): 1µm
- Setting rings and dial indicators are optional

Code	Range	Quantity of points	Measuring range of point	Measuring depth (L1)	Total length (L)	Setting ring (optional)	
						Code	Diameter
2429-4	1.5-4.2	10	1.5-1.9	17	93	6312-1D75	1.75
			1.8-2.2	17	93	6312-2	2
			2.05-2.45	17	93	6312-2D25	2.25
			2.3-2.7	25	101	6312-2D5	2.5
			2.55-2.95	25	101	6312-2D75	2.75
			2.8-3.2	25	101	6312-3	3
			3.05-3.45	25	101	6312-3D25	3.25
			3.3-3.7	25	101	6312-3D5	3.5
			3.55-3.95	25	101	6312-3D75	3.75
			3.8-4.2	25	101	6312-4	4
2429-7D5	4.15-7.8	7	4.15-4.8	41	118	6312-4D5	4.5
			4.7-5.3	41	118	6312-5	5
			5.2-5.8	41	118	6312-5D5	5.5
			5.7-6.3	41	118	6312-6	6
			6.2-6.8	41	118	6312-6D5	6.5
			6.7-7.3	41	118	6312-7	7
			7.2-7.8	45	118	6312-7D5	7.5
2429-12	7.7-12.5	6	7.7-8.3	45	118	6312-8	8
			8.2-8.8	45	118	6312-8D5	8.5
			8.7-9.3	45	118	6312-9	9
			9.2-10.5	45	118	6312-10	10
			10.2-11.5	45	118	6312-11	11
			11.2-12.5	45	118	6312-12	12
2429-20	12.2-20.6	8	12.2-13.5	45	118	6312-13	13
			13.4-14.6	45	118	6312-14	14
			14.4-15.6	45	118	6312-15	15
			15.4-16.6	45	118	6312-16	16
			16.4-17.6	45	118	6312-17	17
			17.4-18.6	45	118	6312-18	18
			18.4-19.6	45	118	6312-19	19
			19.4-20.6	45	118	6312-20	20



- Applicable for 0.01mm or 0.001mm graduation dial indicators
- Carbide contact point and anvil
- Optional accessory: dial indicator or dial comparator, setting ring (code 6312)

BORE GAGES FOR SMALL HOLES

dial comparator is not included

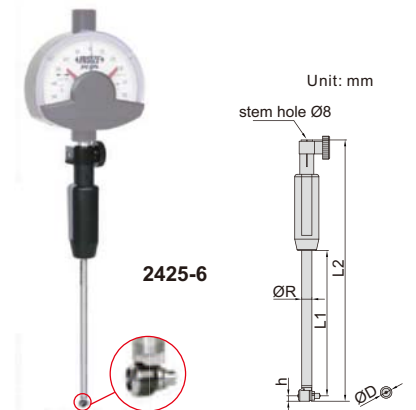

2425-6

Code	Range	Accuracy (without dial comparator)	Repeatability (without dial comparator)	(mm)				
				L1	L2	ØR	ØD	h
2425-6	4.5-6mm	2µm	0.5µm	80	147	4	4	2
2425-8	6-8mm	2µm	0.5µm	100	165	5	5.2	2.6
2425-12	8-12mm	2µm	0.5µm	100	166	5	6.5	3.25
2425-20	12-20mm	2µm	0.5µm	110	204	8	9	4.5

BORE GAGES



dial comparator
is not included



2422-150

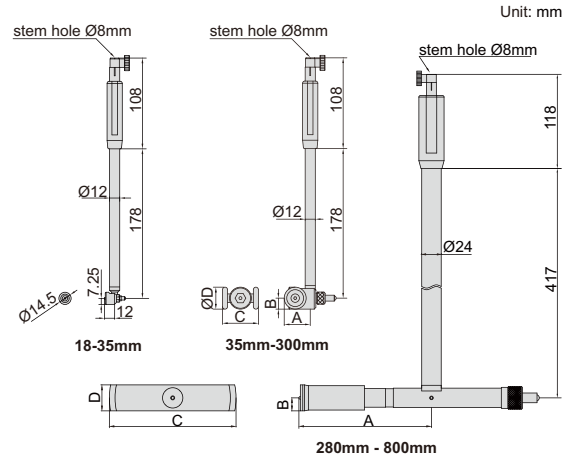

- Applicable for 0.01mm or 0.001mm graduation dial indicators
- Optional accessory:
 - Dial indicator or dial comparator
 - Setting ring (code **6312**)
 - Long handle (code **7352**)

Code	Range	Accuracy (without dial comparator)	Repeatability (without dial comparator)
2422-35	18-35mm	4µm	2µm
2422-60	35-60mm	4µm	2µm
2422-150	50-150mm	4µm	2µm
2422-300	150-300mm	4µm	2µm
2422-510	280-510mm	3µm	1.5µm
2422-800	400-800mm	3µm	1.5µm

Range	A	B	C	D
35-60mm	19.5	10.5	28	21
50-150mm	30.8	13	42.5	26
150-300mm	30.8	13	76.5	26
280-510mm	164	16	156	32
400-800mm	305	18	300	36

BORE GAGE SET

dial comparator
is not included



2423-S2



18-50mm



50-150mm

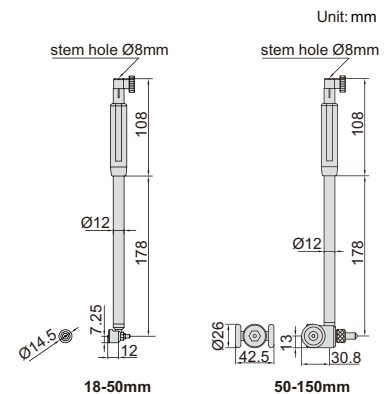

- Includes bore gages 18-50mm and 50-150mm
- Optional accessory:
 - 0.01mm or 0.001mm graduation dial indicator or dial comparator
 - Setting ring (code **6312**)
 - Long handle (code **7352**)

Code	Range	Accuracy (without dial comparator)	Repeatability (without dial comparator)
2423-S2	18 - 150mm	4µm	2µm



SELF-POSITIONING, NO NEED TO FIND TURNING POINT (MINIMUM VALUE)

- Self-positioning, no need to find turning point (minimum value)
- Carbide contact point
- Optional accessory:
 - 0.01mm or 0.001mm graduation dial indicators or dial comparator
 - Setting ring (code 6312)

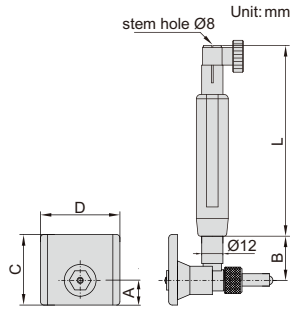

BORE GAGES

dial indicator is not included



2431-80

(mm)

Code	Range	Accuracy (without dial indicator)	Repeatability (without dial indicator)	A	B	C	D	L
2431-35	20-35mm	2µm	1µm	9	21	12	16	89
2431-55	35-55mm	2µm	1µm	10	23	30	28	96
2431-80	50-80mm	2µm	1µm	15	25	40	45	108
2431-120	80-120mm	2µm	1µm	15	25	40	60	108
2431-170	120-170mm	2µm	1µm	18	30	50	88	119

GEAR BORE GAGES

RELATIVE PRODUCT: INTERNAL GEAR TOOTH MICROMETER (CODE 3637, 3638)

- Tungsten carbide ball points, diameter accuracy 2µm
- Optional accessory:
 - Dial indicator or dial comparator
 - Ball points
 - Thread adaptor
 - Setting ring (code 6312)
 - Long handle (code 7352)

dial comparator is not included



2428-55

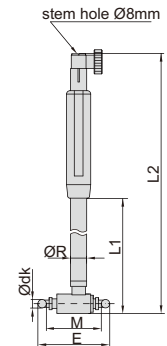

(mm)

Code	Range (E)	Accuracy (without dial comparator)	Repeatability (without dial comparator)	ØR	L1	L2	Thread for ball points
2428-12	8-12mm	2µm	0.5µm	5	100	165	M1.6
2428-22	12-22mm	2µm	0.5µm	5	102	168	M1.6
2428-55	22-55mm	2µm	0.5µm	8	110	204	M2.5
2428-250	55-250mm	2µm	0.5µm	12	177	290	M4
2428-510	250-510mm	2µm	0.5µm	18	235	363	M4

ball points (optional)

Ball points (optional)

Ball point diameter Ødk	2428-12	2428-22	2428-55	2428-250	2428-510
	point thread M1.6	point thread M1.6	point thread M2.5	point thread M4	point thread M4
	point code	point code	point code	point code	point code
1mm	2428-A1	2428-A1	2428-B1	2428-C1	2428-C1
1.5mm	2428-A1D5	2428-A1D5	2428-B1D5	2428-C1D5	2428-C1D5
2mm	2428-A2	2428-A2	2428-B2	2428-C2	2428-C2
2.5mm	—	2428-A2D5	2428-B2D5	2428-C2D5	2428-C2D5
3mm	—	2428-A3	2428-B3	2428-C3	2428-C3
3.5mm	—	2428-A3D5	2428-B3D5	2428-C3D5	2428-C3D5
4mm	—	2428-A4	2428-B4	2428-C4	2428-C4
4.5mm	—	—	2428-B4D5	2428-C4D5	2428-C4D5
5mm	—	—	2428-B5	2428-C5	2428-C5
5.5mm	—	—	2428-B5D5	2428-C5D5	2428-C5D5
6mm	—	—	2428-B6	2428-C6	2428-C6
6.5mm	—	—	2428-B6D5	2428-C6D5	2428-C6D5
7mm	—	—	2428-B7	2428-C7	2428-C7
7.5mm	—	—	2428-B7D5	2428-C7D5	2428-C7D5
8mm	—	—	2428-B8	2428-C8	2428-C8
8.5mm	—	—	2428-B8D5	2428-C8D5	2428-C8D5
9mm	—	—	2428-B9	2428-C9	2428-C9
9.5mm	—	—	2428-B9D5	2428-C9D5	2428-C9D5
10mm	—	—	2428-B10	2428-C10	2428-C10

ball points (optional), in pair



extension rod for points (included)

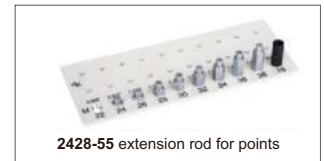

2428-55 extension rod for points

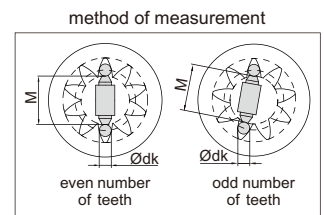
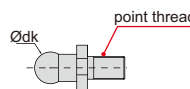

Thread adaptor (optional)

Code	Thread	Remark
2428-D1	M1.6/M2.5	For example, use 2428-A1 with 2428-D1 to replace 2428-B1
2428-D2	M2.5/M4	For example, use 2428-B1 with 2428-D2 to replace 2428-C1

BORE GAGES FOR BLIND HOLES

- To measure diameter of shallow and blind holes
- Optional accessory:
 - 0.01mm or 0.001mm graduation dial indicators
 - Setting ring (code **6312**)
 - Long handle (code **7352**)



(mm)

Code	Range	Accuracy (without dial indicator)	Repeatability (without dial indicator)	C
2424-50	20-50mm	4µm	1µm	18
2424-110	50-110mm	4µm	1µm	34
2424-300	110-300mm	4µm	1µm	81
2424-600	300-600mm	4µm	1µm	140

dial indicator is not included

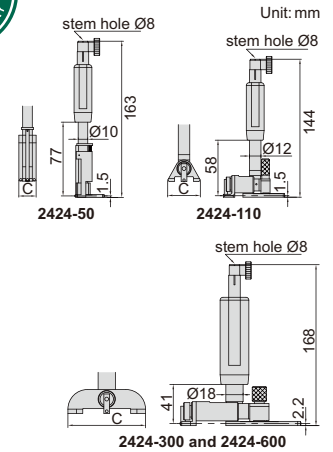

ROTARY BORE GAGE

- Rotary anvil, to measure bores with small opening
- D: bore diameter to be measured, d: minimum opening diameter (see right drawing)
- d=57mm (D≤95mm)
- d=D-38 (D>95mm)
- Optional accessory:
 - 0.01mm or 0.001mm graduation dial indicator or dial comparator
 - Setting ring (code **6312**)
 - Long handle (code **7352**)

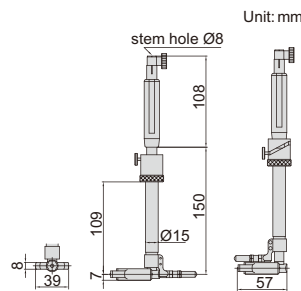

Unit: mm

Code	Range	Accuracy (without dial indicator)	Repeatability* (without dial indicator)
2921-150	80-150mm	2µm	1µm

* Repeatability includes the error of rotary anvil

dial indicator is not included



2921-150

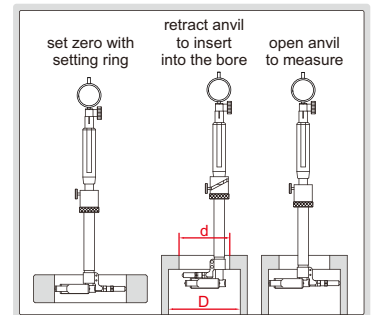

BORE GAGES

MEASURE DIAMETER OF BORES WITH BARRIER INSIDE

ATTENTION: NOT SUITABLE FOR 0.001MM DIAL INDICATORS

- Measure diameter of bores with barrier inside
- Optional accessory:
 - 0.01mm graduation dial indicators
 - Setting ring (code **6312**)

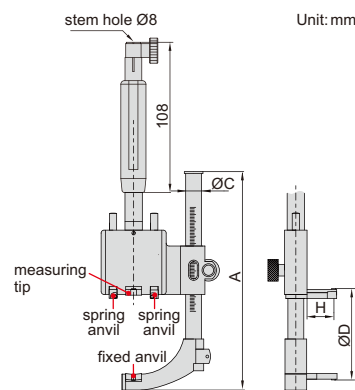
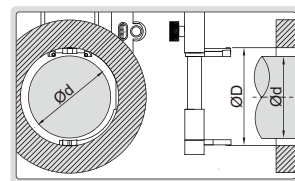

Unit: mm

dial indicator is not included

Code	Range ØD	Diameter of barrier Ød	Travel of measuring tip	Measuring depth H	Accuracy (without dial indicator)	Measuring force	A	ØC
2432-70	25-70mm	<D-6 (less than 45mm)*	2.5	12	0.01	1.5N	115	10
2432-105	35-105mm	<D-11 (less than 70mm)*	3.0	18	0.01	2.5N	150	11
2432-210	100-210mm	<D-20 (less than 130mm)*	3.5	30	0.015	2.5N	233	15
2432-280	100-280mm	<D-20 (less than 130mm)*	3.5	30	0.015	2.5N	303	15
2432-500	200-500mm	<D-20 (less than 240mm)*	3.5	30	0.02	2.5N	622	30

(mm)



2432-105

* For example, range of 2432-70 is 25-70mm, diameter of barrier is <D-6 (less than 45mm). When measuring size is 40mm, D-6=34mm, so the maximum diameter of barrier is 34mm. When measuring size is 60mm, D-6=54mm, however it should be less than 45mm, so the maximum diameter of barrier is 45mm.



INTERNAL GROOVE BORE GAGES

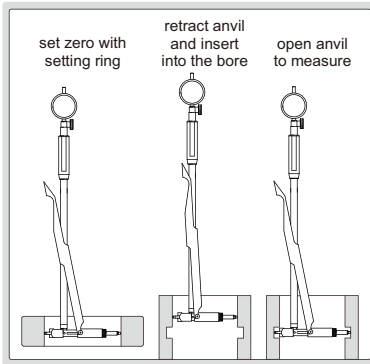

dial indicator is not included

2433-180

anvil (optional)

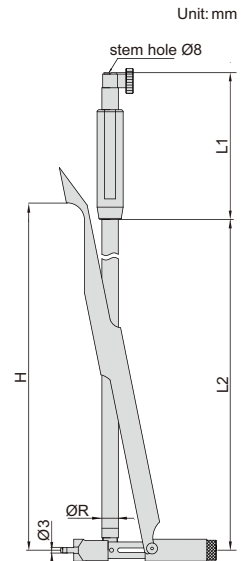

- Measure diameter of internal grooves (width of groove > 3mm)
- Anvil is needed
- Optional accessory:
 - 0.001mm graduation dial indicators
 - Setting ring (code 6312)

Code	Range	Retraction of anvil	Measuring depth H	Accuracy (without dial indicator)	Repeatability (without dial indicator)	ØR	L1	L2
2433-120	60-120mm	8.5	180	2µm	1µm	10	105	215
2433-180	120-180mm	23	230	2µm	1µm	12	108	285
2433-300	180-300mm	30	230	2µm	1µm	18	130	285

(mm)

ANVIL (OPTIONAL)

Code	Remark
2433-P□□□□	We design and make anvils according to the grooves to be measured. *

* Note: please provide the dimension of grooves to be measured.



LONG HANDLES

- To assist deep-hole measurement
- Can be used for bore gages 2422, 2423, 2424 and 2921



7352-500

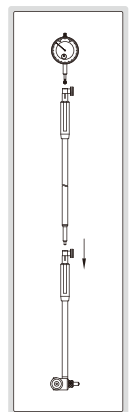
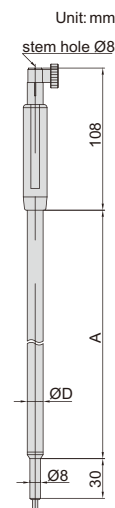

Code	Applicable bore gages	A	ØD
7352-500	above 35mm	438	12
7352-1000		938	12

(mm)

BORE GAGES FOR SMALL HOLES

ATTENTION: NOT SUITABLE FOR 0.001MM DIAL INDICATORS

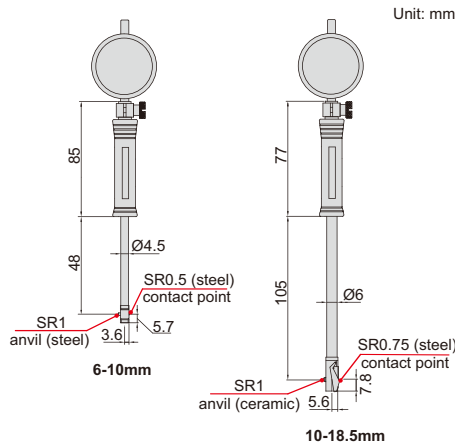
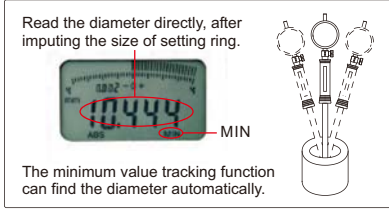
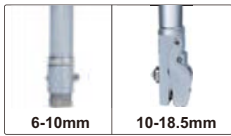

Optional accessory: setting ring (code 6312)

Code	Range	Indicator	Accuracy	Repeatability
2852-10	6-10mm	dial indicator, range 3mm, graduation 0.01mm (code 2311-3F)	±0.012mm	0.003mm
2852-18	10-18.5mm	dial indicator, range 3mm, graduation 0.01mm (code 2311-3F)	±0.012mm	0.003mm

Code	Range	Indicator	Accuracy	Repeatability
2152-10	6-10mm	digital indicator, range 12.7mm/0.5", resolution 0.002mm/0.0001" (code 2108-10F)	±0.012mm	0.003mm
2152-18	10-18.5mm	digital indicator, range 12.7mm/0.5", resolution 0.002mm/0.0001" (code 2108-10F)	±0.012mm	0.003mm

BORE GAGES

ATTENTION: NOT SUITABLE FOR 0.001MM DIAL INDICATORS

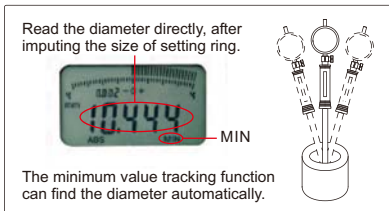

(mm)

Range	A	B	C	ØD	ØE	F	L
35-60mm	22	9	27	13	12.8	SR2	141
50-100mm	26	9	35	13	12.8	SR2	141
50-160mm	26	9	35	13	12.8	SR2	141
100-160mm	26	9	35	13	12.8	SR2	141
160-250mm	56.5	13	74.5	15	12.8	SR2	241
250-450mm	86.5	15	101.5	15	14.5	SR2.5	241

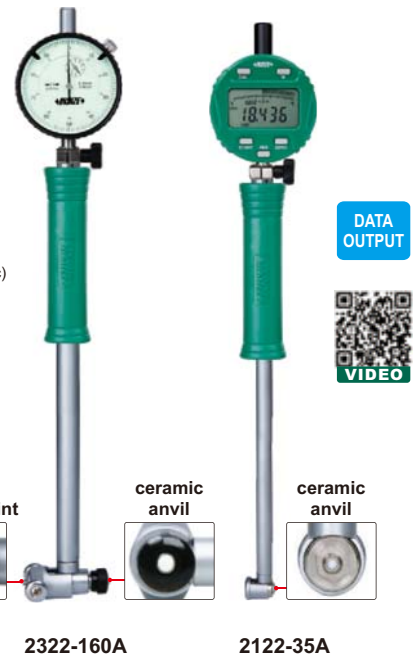
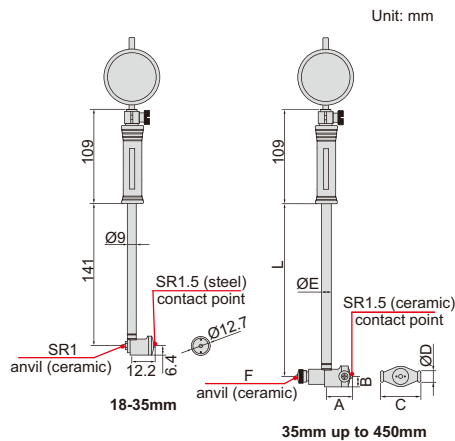

Code	Range	Indicator	Accuracy	Repeatability
2322-35A	18-35mm	dial indicator, range 10mm, graduation 0.01mm (code 2308-10FA)	±0.015mm	0.003mm
2322-60A	35-60mm		±0.018mm	0.003mm
2322-100A	50-100mm		±0.018mm	0.003mm
2322-160A	50-160mm		±0.018mm	0.003mm
2322-161A	100-160mm		±0.018mm	0.003mm
2322-250A	160-250mm		±0.018mm	0.003mm
2322-450A	250-450mm		±0.018mm	0.003mm

Code	Range	Indicator	Accuracy	Repeatability
2122-35A	18-35mm	digital indicator, range 12.7mm/0.5", resolution 0.002mm/0.0001" (code 2108-10F)	±0.015mm	0.003mm
2122-60A	35-60mm		±0.018mm	0.003mm
2122-100A	50-100mm		±0.018mm	0.003mm
2122-160A	50-160mm		±0.018mm	0.003mm
2122-161A	100-160mm		±0.018mm	0.003mm
2122-250A	160-250mm		±0.018mm	0.003mm
2122-450A	250-450mm		±0.018mm	0.003mm

Optional accessory: setting ring (code 6312), long handle (code 7351)

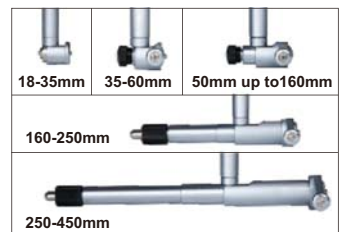

BORE GAGE SETS

ATTENTION: NOT SUITABLE FOR 0.001MM DIAL INDICATORS



packaging (code 2824-S3)



■ Optional accessory: setting ring (code 6312)

Code	Range	Indicator	Bore gages included	Accuracy	Repeatability
2824-S160	35-160mm	dial indicator, code 2308-10FA range 10mm, graduation 0.01mm	① 35-50mm (dial indicator and handle are not included) ② 50-160mm	35-50mm ±0.018mm 50-160mm ±0.018mm	0.003mm
2824-S3	18-160mm	dial indicator, code 2308-10FA range 10mm, graduation 0.01mm	① 18-35mm ② 35-60mm (dial indicator is not included) ③ 50-160mm (dial indicator is not included)	18-35mm ±0.015mm 35-60mm ±0.018mm 50-160mm ±0.018mm	0.003mm

BORE GAGES

ATTENTION: NOT SUITABLE FOR 0.001MM DIAL INDICATORS

■ Optional accessory: setting ring (code 6312)



2827-160A

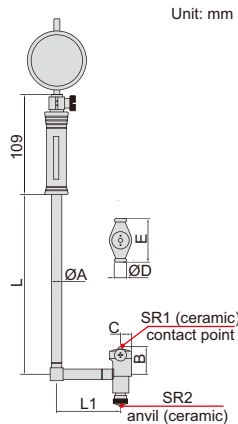

Unit: mm

Range	ØA	B	C	ØD	E	L	L1
35-60mm	12.8	22	9	13	27	141	75
50-160mm	12.8	28.5	9.2	13	35	141	76.2
160-250mm	14.5	62.0	12.7	15	74.5	391	100
250-450mm	14.5	91.5	15.0	15	101.5	391	100

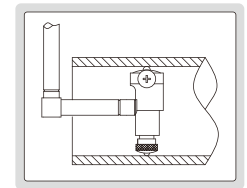

Code	Range	Indicator	Accuracy	Repeatability
2827-60A	35-60mm	dial indicator code 2308-10FA range 10mm, graduation 0.01mm	±0.018mm	0.003mm
2827-160A	50-160mm		±0.018mm	0.003mm
2827-250A	160-250mm		±0.018mm	0.003mm
2827-450A	250-450mm		±0.018mm	0.003mm

ATTENTION: NOT SUITABLE FOR 0.001MM DIAL INDICATORS

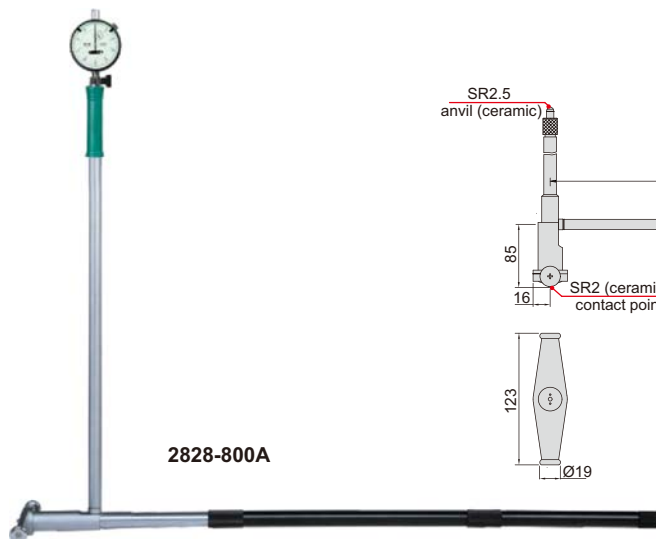

2828-800A

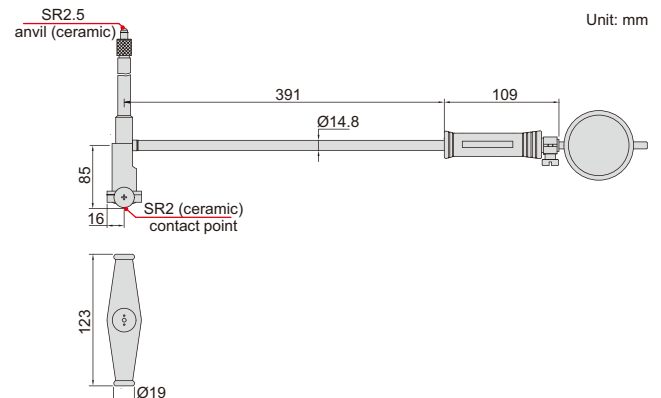

Unit: mm

Code	Range	Indicator	Accuracy	Repeatability
2828-800A	400-800mm	dial indicator code 2308-10FA, range 10mm, graduation 0.01mm	±0.025mm	0.003mm

LONG HANDLES

- To assist deep-hole measurement
- Can be used for bore gages 2322 and 2122

Code	Applicable bore gages	A	ØD	Type
7351-EX11	35-60mm,	475	13	B
7351-EX12	50-100mm,	980	13	
7351-EX13	50-160mm,	1480	14.5	A
7351-EX14	100-160mm	1980	14.5	
7351-EX21	160-250mm, 250-450mm	480	14.5	B
7351-EX22		980	14.5	A
7351-EX23		1480	14.5	
7351-EX24		1980	14.5	

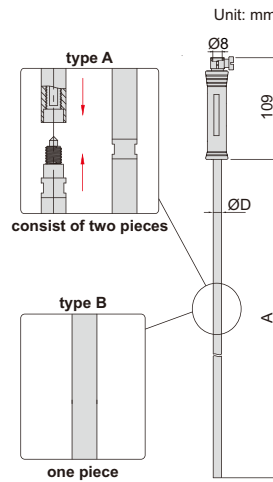

7351-EX11

method of use (replace the original handle with long handle)

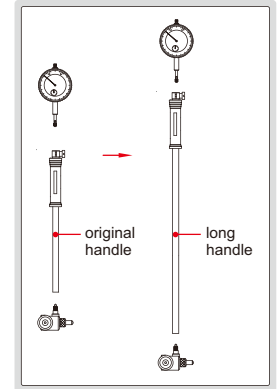

ANVILS FOR BORE GAGES



7350-160

- For 2852, 2152, 2322, 2122, 2824, 2827

Code	Applicable bore gages	Material of measuring face	Quantity per set	Measuring range of anvil (mm)
7350-10	6-10mm	steel	9pcs	6, 6.5, 7, 7.5, 8, 8.5, 9, 9.5, 10
7350-18	10-18.5mm	ceramic	9pcs	10, 11, 12, 13, 14, 15, 16, 17, 18
7350-35	18-35mm	ceramic	9pcs	18, 20, 22, 24, 26, 28, 30, 32, 34
7350-60	35-60mm	ceramic	6pcs	35, 40, 45, 50, 55, 60
7350-100	50-100mm	ceramic	11pcs	50, 55, 60, 65, 70, 75, 80, 85, 90, 95, 100
7350-160	50-160mm	ceramic	12pcs	50, 55, 60, 65, 70, 75, 80, 85, 90, 95, 100, 105
7350-161	100-160mm	ceramic	12pcs	50, 55, 60, 65, 70, 75, 80, 85, 90, 95, 100, 105
7350-250	160-250mm	ceramic	5pcs	160, 170, 180, 190, 200
7350-450	250-450mm	ceramic	5pcs	250, 260, 270, 280, 290

BORE GAGE SETTER

- Used together with gage blocks to set bore gages

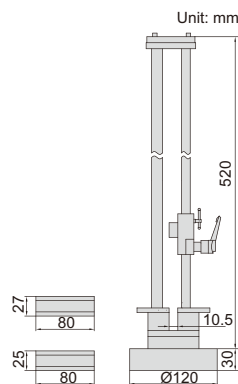

2395-400

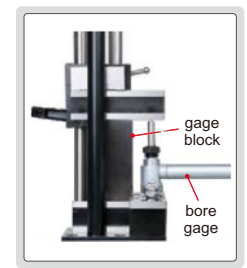

Code	Setting range
2395-400	18-400mm

SETTING RINGS

CAN SUPPLY CUSTOM SETTING RING FROM Ø1.500MM TO Ø315.000MM, FOR EXAMPLE, Ø17.085MM



6312-20

- For zero setting of inside micrometers, three points internal micrometers and bore gages
- Deviation (difference between the ordered size and the size marked on the setting ring when supplied):
For example, the ordered size is Ø10.125mm, the size marked on the setting ring when supplied may be Ø10.127mm
- Meet DIN2250-1:2008

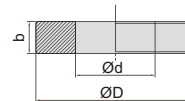

Ø1.5mm-100mm

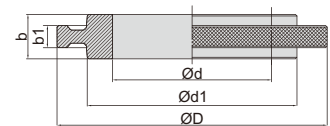

Ø100mm-315mm

(mm)

Diameter d**	b	D	Deviation	Roundness and cylindricity
Ø1.5-2.5	4	22	±2.0µm	0.3µm
Ø2.5-3	5	22	±2.0µm	0.3µm
Ø3-5	5	22	±2.0µm	0.4µm
Ø5-10	8	32	±2.0µm	0.4µm
Ø10-15	10	38	±3.0µm	0.5µm
Ø15-18	12	45	±3.0µm	0.5µm
Ø18-20	12	45	±3.0µm	0.6µm
Ø20-25	14	53	±3.0µm	0.6µm
Ø25-30	16	63	±4.0µm	0.6µm
Ø30-32	16	63	±4.0µm	0.7µm
Ø32-40	18	71	±4.0µm	0.7µm
Ø40-50	20	85	±4.0µm	0.7µm
Ø50-60	20	100	±4.0µm	0.8µm
Ø60-70	24	112	±4.0µm	0.8µm
Ø70-80	24	125	±4.0µm	0.8µm
Ø80-90	24	140	±4.0µm	1.0µm
Ø90-100	24	160	±4.0µm	1.0µm

** For example Ø3-5mm means Ø3mm< diameter d ≤ 5mm

(mm)

Diameter d**	b	b1	d1	D	Deviation	Roundness and cylindricity
Ø100-110	28	14	132	170	±5.0µm	1.0µm
Ø110-120	28	16	140	180	±5.0µm	1.0µm
Ø120-130	28	16	150	190	±6.0µm	1.2µm
Ø130-140	28	18	160	200	±6.0µm	1.2µm
Ø140-150	28	18	170	212	±6.0µm	1.2µm
Ø150-160	28	20	180	224	±6.0µm	1.2µm
Ø160-170	32	20	190	236	±6.0µm	1.2µm
Ø170-180	32	20	200	250	±6.0µm	1.2µm
Ø180-190	32	22	212	265	±7.0µm	1.4µm
Ø190-200	32	22	224	280	±7.0µm	1.4µm
Ø200-212	32	22	236	300	±7.0µm	1.4µm
Ø212-224	32	25	250	315	±7.0µm	1.4µm
Ø224-236	36	25	265	335	±7.0µm	1.4µm
Ø236-250	36	28	280	355	±7.0µm	1.4µm
Ø250-265	36	28	300	375	±8.0µm	1.6µm
Ø265-280	36	28	315	400	±8.0µm	1.6µm
Ø280-300	36	32	335	425	±8.0µm	1.6µm
Ø300-315	36	32	355	450	±8.0µm	1.6µm

(mm)

Code	Size
6312-1D5*	Ø1.5
6312-2*	Ø2
6312-3*	Ø3
6312-4*	Ø4
6312-5*	Ø5
6312-6*	Ø6
6312-7*	Ø7
6312-8*	Ø8
6312-9*	Ø9
6312-10*	Ø10
6312-11*	Ø11
6312-12*	Ø12
6312-13*	Ø13
6312-14*	Ø14
6312-15*	Ø15
6312-16*	Ø16

(mm)

Code	Size
6312-17*	Ø17
6312-18*	Ø18
6312-19*	Ø19
6312-20*	Ø20
6312-21*	Ø21
6312-22*	Ø22
6312-23*	Ø23
6312-24*	Ø24
6312-25*	Ø25
6312-26*	Ø26
6312-27*	Ø27
6312-28*	Ø28
6312-29*	Ø29
6312-30*	Ø30
6312-31*	Ø31
6312-32*	Ø32

(mm)

Code	Size
6312-33*	Ø33
6312-34*	Ø34
6312-35*	Ø35
6312-36*	Ø36
6312-37*	Ø37
6312-38*	Ø38
6312-39*	Ø39
6312-40*	Ø40
6312-41*	Ø41
6312-42*	Ø42
6312-43*	Ø43
6312-44*	Ø44
6312-45*	Ø45
6312-46*	Ø46
6312-47*	Ø47
6312-48*	Ø48

(mm)

Code	Size
6312-49*	Ø49
6312-50*	Ø50
6312-55*	Ø55
6312-60*	Ø60
6312-62*	Ø62
6312-65*	Ø65
6312-70*	Ø70
6312-75*	Ø75
6312-80*	Ø80
6312-85*	Ø85
6312-87*	Ø87
6312-90*	Ø90
6312-95*	Ø95
6312-100*	Ø100
6312-112D5	Ø112.5
6312-125*	Ø125

(mm)

Code	Size
6312-137D5*	Ø137.5
6312-150*	Ø150
6312-162D5*	Ø162.5
6312-175*	Ø175
6312-187D5*	Ø187.5
6312-200*	Ø200
6312-212D5*	Ø212.5
6312-225*	Ø225
6312-237D5*	Ø237.5
6312-250*	Ø250
6312-262D5*	Ø262.5
6312-275*	Ø275
6312-287D5*	Ø287.5
6312-300*	Ø300

* Supplied with manufacturer inspection certificate

INTERNAL CHAMFER GAGES

- Measure end diameter of chamfer or taper holes
- With limit pointers

Code	Range $\varnothing D$	Applicable angle α	Graduation	Accuracy	$\varnothing d$
2941-20	0.5-20.1mm	0-90°	0.01mm	±0.02mm	28.3
2941-40	20-40mm	0-90°	0.01mm	±0.02mm	50
2941-203	0.5-20.1mm	90-127°	0.02mm	±0.04mm	28.3
2941-403	20-40mm	90-127°	0.02mm	±0.04mm	50

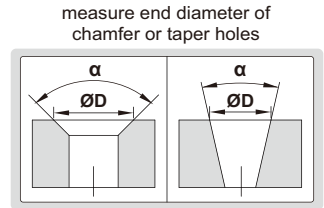
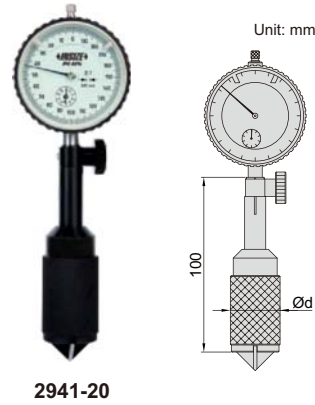

DIGITAL INTERNAL CHAMFER GAGES

- Measure end diameter of chamfer or taper holes
- Resolution: 0.01mm/0.0005"

Code	Range $\varnothing D$	Applicable angle α	Accuracy	$\varnothing d$
2942-20	0.5-20.1mm	0-90°	±0.02mm	28.3
2942-40	20-40mm	0-90°	±0.02mm	50
2942-203	0.5-20.1mm	90-127°	±0.04mm	28.3
2942-403	20-40mm	90-127°	±0.04mm	50

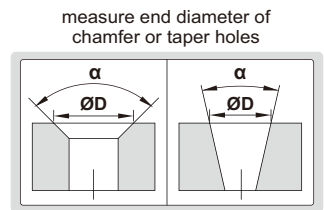
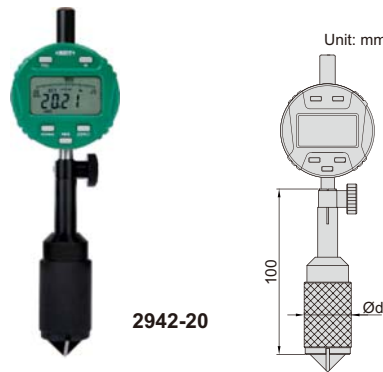

SMALL HOLE GAGE SET

- 4 gages per set
- For small holes, slots and grooves, etc.
- Satin chrome finish

Range	L	a	$\varnothing b$
3-5mm	90	22.5	5.5
5-7.5mm	97.6	30	5.5
7.5-10mm	102.8	35	8.5
10-13mm	108	40	8.5

Code	Total range	Gages included
4208-1	3-13mm	3-5mm, 5-7.5mm, 7.5-10mm, 10-13mm

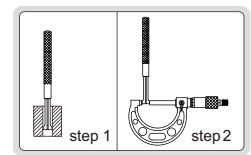
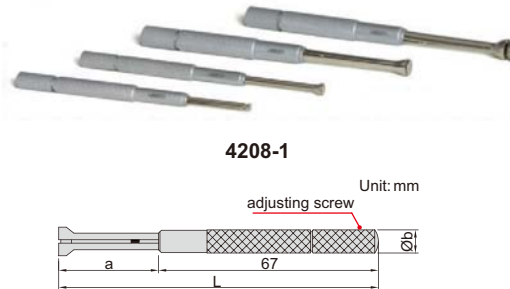

TELESCOPING GAGE SET

- 6 gages per set
- For quick measurement of inside diameter of holes and width of slots
- Satin chrome finish

Range	L	$\varnothing a$	$\varnothing b$	$\varnothing c$
8-12.7mm	115	3.9	2.9	6.2
12.7-19mm	115	5.3	3.8	6.2
19-32mm	115	5.3	3.8	6.2
32-54mm	137	7.6	6.1	7.2
54-90mm	137	7.6	6.1	7.2
90-150mm	137	7.6	6.1	7.2

Code	Total range	Gages included
4206-1	8-150mm	8-12.7mm, 12.7-19mm, 19-32mm, 32-54mm, 54-90mm, 90-150mm

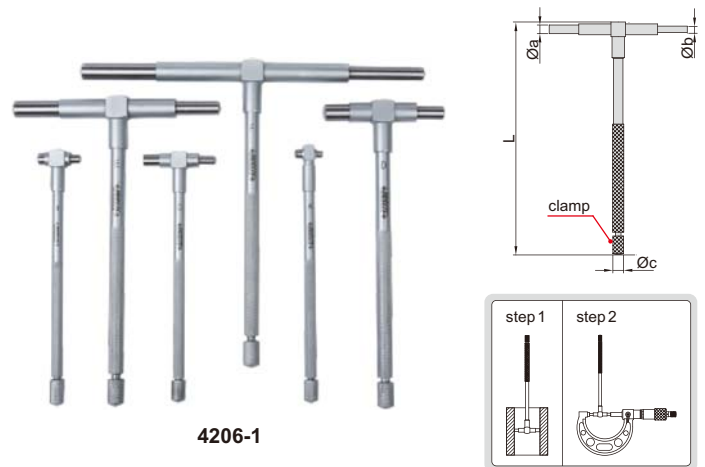

LONG HANDLE TELESCOPING GAGES

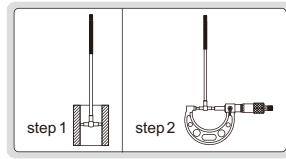
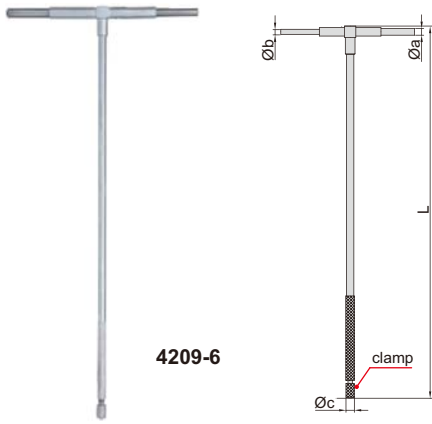

- For quick measurement of inside diameter of deep holes and width of slots
- Satin chrome finish

(mm)					
Code	Range	L	Øa	Øb	Øc
4209-1	8-12.7mm	250	3.9	2.9	6.2
4209-2	12.7-19mm	250	5.3	3.8	6.2
4209-3	19-32mm	250	5.3	3.8	6.2
4209-4	32-54mm	300	7.6	6.1	7.2
4209-5	54-90mm	300	7.6	6.1	7.2
4209-6	90-150mm	300	7.6	6.1	7.2



DATA OUTPUT



LARGE DIAMETER GAGE CODE ISQ-RA600

- To measure large external or internal diameters
- Automatic judgment and display external or internal diameter
- Titanium arm, light in weight
- Backlight LCD display, can rotate 180° for easy reading
- Memory of 12 readings and average calculation
- With minimum and maximum measurement mode
- Angle can be displayed

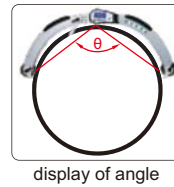
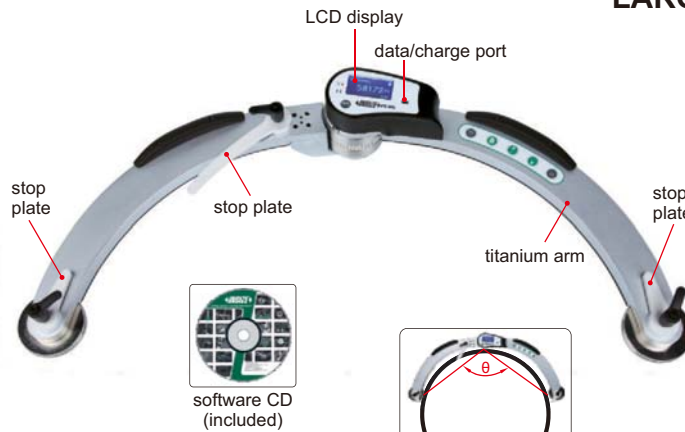

Accuracy sample by diameters

Diameter	Accuracy
500mm	±0.018mm
1000mm	±0.043mm
1500mm	±0.085mm
2000mm	±0.143mm
2500mm	±0.218mm
3000mm	±0.310mm
4000mm	±0.543mm
5000mm	±0.843mm
6000mm	±1.210mm

SPECIFICATION

Range	external	Ø500~6000mm/19.69~236.22"
	internal	Ø1100~6000mm/43.31~236.22"
Resolution	0.01mm/0.001"	
Accuracy	±(0.01+D²/30)mm (D is the diameter to be measured, in meter)	
Power supply	rechargeable battery (for 8 hours working)	
Weight	3.8kg	

STANDARD DELIVERY

Main unit	1pc
AC/DC adapter	1pc
USB cable and software	1pc

- Buttons: on/off, hold, mm/inch, s (select jaws), zero
- Measure radius of internal or external arcs
- Display can be rotated by 320°
- Supplied with 5 jaws for different sizes of arc
- Battery CR2032, automatic power off

ATTENTION: NO DATA OUTPUT



DIGITAL RADIUS GAGE

Measuring jaw	Range of radius (R)
10mm	5-11mm
20mm	11-22mm
30mm	22-83mm
60mm	83-250mm
100mm	250-910mm

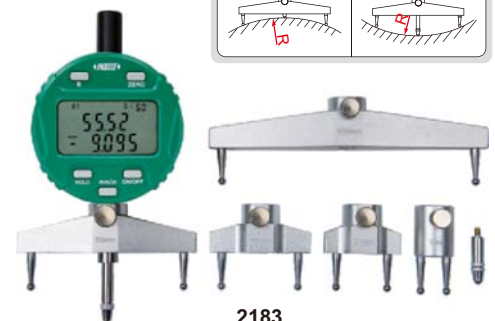
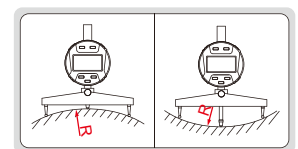
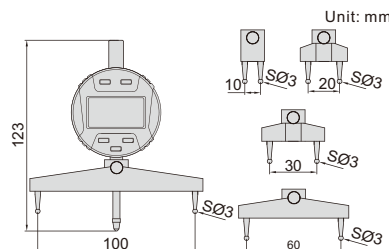

2183

Code	Range of radius (R)	Resolution	Accuracy (mm)
2183	5-910mm/0.2-35.83"	0.005mm/0.00005"	±0.01R*

* R is the radius to be measured

TAPE BORE GAGES



MEASURE INTERNAL DIAMETER OF FLEXIBLE MATERIALS (FOR EXAMPLE, BELT)

- Graduation: 0.1mm
- Accuracy: 0.2mm

(mm)				
Code	Range ØD	Ød	ØA	Measuring depth
2430-24	14-24mm	13.5	13	15-60
2430-40	22-40mm	21.5	21	15-60
2430-60	35-60mm	34.5	30.5	15-96
2430-100	55-100mm	54.5	30.5	15-106
2430-180	95-180mm	94.5	30.5	15-106
2430-255	170-255mm	169.5	30.5	15-106
2430-330	245-330mm	244.5	30.5	15-106

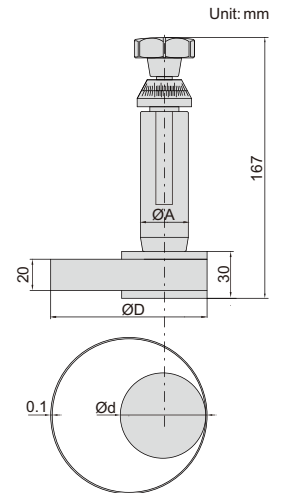

CIRCUMFERENCE TAPES

ATTENTION: BASIC MODEL

- Graduation: 0.1mm
- Measure diameter and circumference of pipes, trees, tires, etc.
- Laser engraved scale
- Made of stainless steel



7114-950

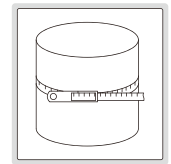

Code	Circumference range	Diameter range	Accuracy	
			Circumference	Diameter
7114-950	60-950mm	Ø20-300mm	±1.5mm	±0.5mm
7114-2200	940-2200mm	Ø300-700mm	±1.5mm	±0.5mm
7114-3460	2190-3460mm	Ø700-1100mm	±1.5mm	±0.5mm

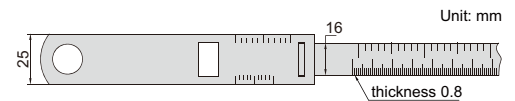

CIRCUMFERENCE TAPES



- Graduation: 0.1mm
- Measure diameter and circumference of pipes, trees, tires, etc.
- Laser engraved scale
- Made of stainless steel



7115-3460

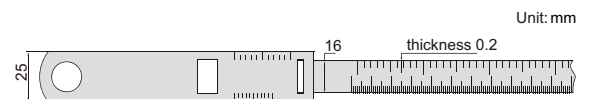

Code	Circumference range	Diameter range	Accuracy	
			Circumference	Diameter
7115-950*	150-950mm	Ø50-300mm	±0.60mm	±0.20mm
7115-2200	940-2200mm	Ø300-700mm	±0.60mm	±0.20mm
7115-3460	2190-3460mm	Ø700-1100mm	±0.60mm	±0.20mm
7115-4720	3450-4720mm	Ø1100-1500mm	±0.90mm	±0.30mm
7115-5980	4710-5980mm	Ø1500-1900mm	±0.90mm	±0.30mm

* When diameter range Ø50-100mm, the accuracy of circumference is ±0.90mm, diameter is ±0.30mm.

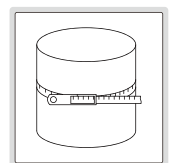



CIRCUMFERENCE TAPES

- Measure diameter of cables, thin plastic pipes, etc., which may deform
- Laser engraved scale
- Made of stainless steel

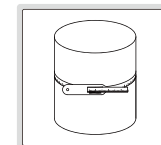

7116-115

Code	Diameter range	Graduation	Accuracy
7116-115	Ø20-115mm	0.05mm	±0.10mm
7116-230	Ø100-230mm	0.05mm	±0.10mm
7116-330	Ø200-330mm	0.05mm	±0.15mm
7116-620	Ø300-620mm	0.05mm	±0.20mm

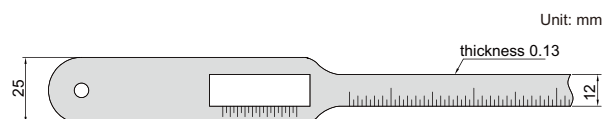

Unit: mm



INTERNAL CIRCUMFERENCE TAPES

- Measure internal diameter and circumference of tubes, belts, etc.
- Laser engraved scale
- Made of stainless steel
- Optional accessory: Holder (code 7125-HOLDER)



7125-1550

Code	Circumference range	Diameter range	Graduation	Accuracy	
				Circumference	Diameter
7125-1550	720-1550mm	Ø230-490mm	0.1mm	±0.35mm	±0.20mm
7125-2200	940-2200mm	Ø300-700mm	0.1mm	±0.35mm	±0.20mm
7125-3620	2190-3620mm	Ø700-1100mm	0.1mm	±0.45mm	±0.23mm
7125-4720	3450-4720mm	Ø1100-1500mm	0.1mm	±0.45mm	±0.23mm
7125-5980	4710-5980mm	Ø1500-1900mm	0.1mm	±0.50mm	±0.25mm
7125-7230	5970-7230mm	Ø1900-2300mm	0.1mm	±0.55mm	±0.27mm
7125-8500	7220-8500mm	Ø2300-2700mm	0.1mm	±0.55mm	±0.27mm

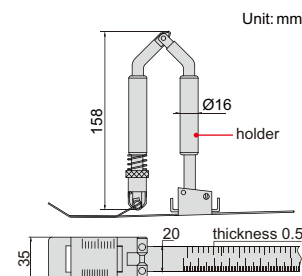

Unit: mm

application



HOLDER (OPTIONAL)

Code	Remark
7125-HOLDER	Suitable for internal circumference taps

- Button function:
 - in/mm: short press for inch/metric conversion
 - long press to change measuring direction
 - ABS: short press for absolute/incremental measurement
 - long press to preset data
 - 0/ON: short press to turn on when power is off
 - short press to set zero when power is on
 - long press to turn off
- CR1632 battery, automatic power off
- Data output
- Optional accessory: data output cable (code 7306-40, 7302-SPC3A, 7305-SPC1A), contact points (page 102~103)



DATA OUTPUT

COMPACT DIGITAL INDICATORS



2114-51F

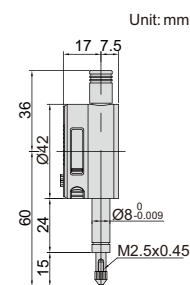

Unit: mm

Code	Range	Resolution	Accuracy	Hysteresis	Remark
2114-5F *	5mm/0.2"	0.01mm/0.0005"	20µm	10µm	flat back
2114-51F *	5mm/0.2"	0.001mm/0.00005"	5µm	2µm	flat back

* Supplied with manufacturer inspection certificate traceable to NIST USA

DIGITAL INDICATORS (STANDARD MODEL)

INSPECTION CERTIFICATE
TRACEABLE TO NIST

DATA OUTPUT

spindle lift knob is included

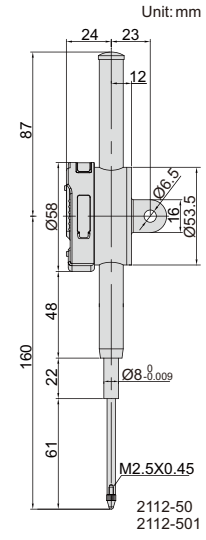
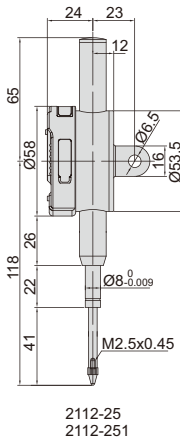
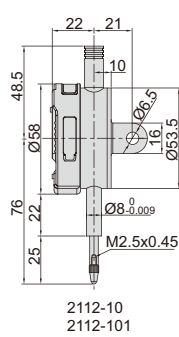

- Button function: on/off, inch/mm, zero
- CR2032 battery, automatic power off
- Data output
- Optional accessory: data output cable (code **7306-40**, **7302-SPC3A**, **7305-SPC1A**), backs (page 104~105), contact points (page 102~103)

Resolution 0.001mm/0.00005"

Code	Range	Accuracy	Hysteresis	Remark
2112-101F*	12.7mm/0.5"	5µm	2µm	flat back
2112-251F*	25.4mm/1"	5µm	3µm	flat back
2112-501F*	50.8mm/2"	6µm	3µm	flat back
2112-101*	12.7mm/0.5"	5µm	2µm	lug back
2112-251*	25.4mm/1"	5µm	3µm	lug back
2112-501*	50.8mm/2"	6µm	3µm	lug back

Resolution 0.01mm/0.0005"

Code	Range	Accuracy	Hysteresis	Remark
2112-10F*	12.7mm/0.5"	20µm	10µm	flat back
2112-25F*	25.4mm/1"	20µm	10µm	flat back
2112-50F*	50.8mm/2"	30µm	10µm	flat back
2112-10*	12.7mm/0.5"	20µm	10µm	lug back
2112-25*	25.4mm/1"	20µm	10µm	lug back
2112-50*	50.8mm/2"	30µm	10µm	lug back

* Supplied with manufacturer inspection certificate traceable to NIST USA

METRIC DIGITAL INDICATORS

INSPECTION CERTIFICATE
TRACEABLE TO NIST

DATA OUTPUT

spindle lift knob is included

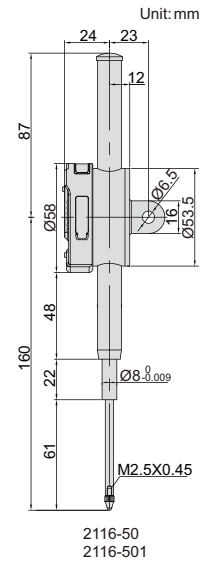
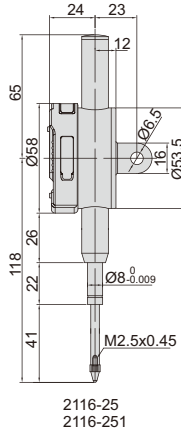
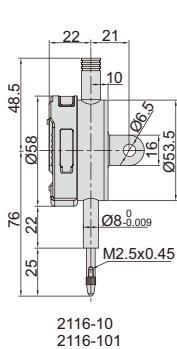

- Button function: on/off, +/-, zero
- CR2032 battery, automatic power off
- Data output
- Optional accessory: data output cable (code **7306-40**, **7302-SPC3A**, **7305-SPC1A**), backs (page 104~105), contact points (page 102~103)

Resolution 0.001mm

Code	Range	Accuracy	Hysteresis	Remark
2116-101F*	12.7mm	5µm	2µm	flat back
2116-251F*	25.4mm	5µm	3µm	flat back
2116-501F*	50.8mm	6µm	3µm	flat back
2116-101*	12.7mm	5µm	2µm	lug back
2116-251*	25.4mm	5µm	3µm	lug back
2116-501*	50.8mm	6µm	3µm	lug back

Resolution 0.01mm

Code	Range	Accuracy	Hysteresis	Remark
2116-10F*	12.7mm	20µm	10µm	flat back
2116-25F*	25.4mm	20µm	10µm	flat back
2116-50F*	50.8mm	30µm	10µm	flat back
2116-10*	12.7mm	20µm	10µm	lug back
2116-25*	25.4mm	20µm	10µm	lug back
2116-50*	50.8mm	30µm	10µm	lug back

* Supplied with manufacturer inspection certificate traceable to NIST USA

INSPECTION CERTIFICATE
TRACEABLE TO NIST

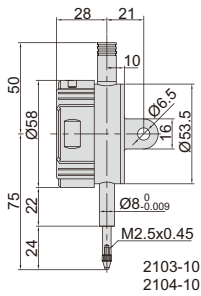
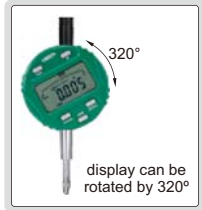

DATA OUTPUT

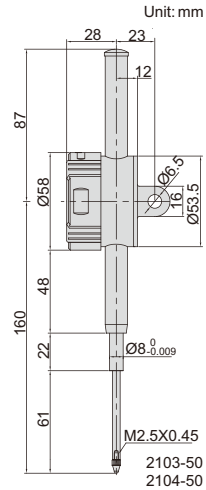
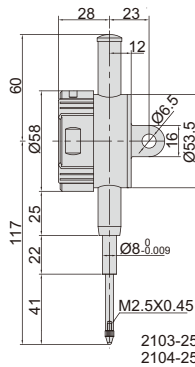

- Reading in digital and analog
- Display can be rotated by 320°
- Button function: tolerance Go and No-Go display, data preset, measuring direction change, max./min./TIR measurement, inch/metric conversion, absolute/incremental measurement
- CR2032 battery, automatic power off
- Data output
- Optional accessory: data output cable (code **7306-40**, **7302-SPC3A**, **7305-SPC1A**), backs (page 104~105), contact points (page 102~103)

spindle lift knob is included



max./min./TIR

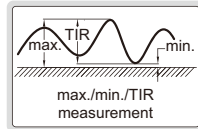

analog pointer



Resolution 0.001mm/0.00005"

Code	Range	Accuracy	Hysteresis	Remark
2103-10F*	12.7mm/0.5"	5µm	2µm	flat back
2103-25F*	25.4mm/1"	5µm	3µm	flat back
2103-50F*	50.8mm/2"	6µm	3µm	flat back
2103-10*	12.7mm/0.5"	5µm	2µm	lug back
2103-25*	25.4mm/1"	5µm	3µm	lug back
2103-50*	50.8mm/2"	6µm	3µm	lug back

Resolution 0.01mm/0.0005"

Code	Range	Accuracy	Hysteresis	Remark
2104-10F*	12.7mm/0.5"	20µm	10µm	flat back
2104-25F*	25.4mm/1"	20µm	10µm	flat back
2104-50F*	50.8mm/2"	30µm	10µm	flat back
2104-10*	12.7mm/0.5"	20µm	10µm	lug back
2104-25*	25.4mm/1"	20µm	10µm	lug back
2104-50*	50.8mm/2"	30µm	10µm	lug back

* Supplied with manufacturer inspection certificate traceable to NIST USA

INSPECTION CERTIFICATE
TRACEABLE TO NIST

ONE BATTERY FOR 4000 WORKING HOURS

DATA OUTPUT

data output cable (optional)



spindle lift knob is included

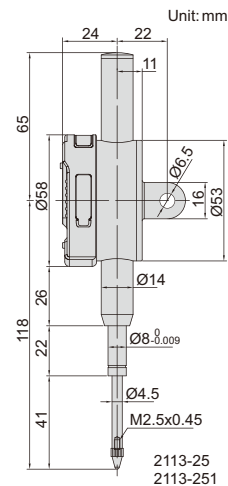
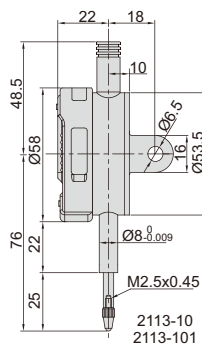

- No auto power off, tracking the deformation of mould and steel structure for a long time
- Low power consumption
- Button function: on/off, zero, inch/mm
- CR2032 battery
- Data output
- Optional accessory: backs (page 104~105), contact points (page 102~103), data output cable (code **7305-SPC1A**)

Resolution 0.001mm/0.00005"

Code	Range	Accuracy	Hysteresis	Remark
2113-101F*	12.7mm/0.5"	5µm	2µm	flat back
2113-251F*	25.4mm/1"	5µm	3µm	flat back
2113-101*	12.7mm/0.5"	5µm	2µm	lug back
2113-251*	25.4mm/1"	5µm	3µm	lug back

Resolution 0.01mm/0.0005"

Code	Range	Accuracy	Hysteresis	Remark
2113-10F*	12.7mm/0.5"	20µm	10µm	flat back
2113-25F*	25.4mm/1"	20µm	10µm	flat back
2113-10*	12.7mm/0.5"	20µm	10µm	lug back
2113-25*	25.4mm/1"	20µm	10µm	lug back

* Supplied with manufacturer inspection certificate traceable to NIST USA

WATERPROOF DIGITAL INDICATORS

**INSPECTION
CERTIFICATE**
TRACEABLE TO NIST

WATERPROOF

DATA
OUTPUT

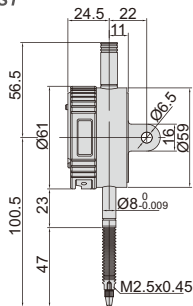

2115-10
2115-101



2115-10

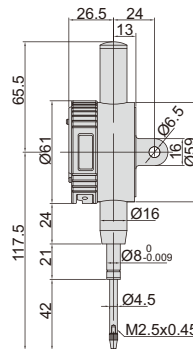

2115-25
2115-251



2115-25

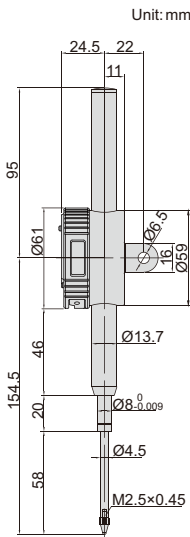

2115-50
2115-501



2115-50

spindle lift knob is included
(except 2115-101/101F, 2115-10/10F)



Resolution 0.001mm/0.00005"

Code	Range	Dust/waterproof	Accuracy	Hysteresis	Remark
2115-101*	12.7mm/0.5"	IP65	5µm	2µm	lug back
2115-251*	25.4mm/1"	IP54	5µm	3µm	lug back
2115-501*	50.8mm/2"	IP54	6µm	3µm	lug back
2115-101F*	12.7mm/0.5"	IP65	5µm	2µm	flat back
2115-251F*	25.4mm/1"	IP54	5µm	3µm	flat back
2115-501F*	50.8mm/2"	IP54	6µm	3µm	flat back

Resolution 0.01mm/0.0005"

Code	Range	Dust/waterproof	Accuracy	Hysteresis	Remark
2115-10*	12.7mm/0.5"	IP65	20µm	10µm	lug back
2115-25*	25.4mm/1"	IP54	20µm	10µm	lug back
2115-50*	50.8mm/2"	IP54	30µm	10µm	lug back
2115-10F*	12.7mm/0.5"	IP65	20µm	10µm	flat back
2115-25F*	25.4mm/1"	IP54	20µm	10µm	flat back
2115-50F*	50.8mm/2"	IP54	30µm	10µm	flat back

* Supplied with manufacturer inspection certificate traceable to NIST USA

- Dust/waterproof
- Button function: on/off, zero, mm/inch
- CR2032 battery, automatic power off
- Data output
- Optional accessory: data output cable (code 7306-40, 7302-SPC3A, 7305-SPC1A), backs (page 104~105), contact points (page 102~103)

DIGITAL INDICATORS FOR BORE GAGES

**INSPECTION
CERTIFICATE**
TRACEABLE TO NIST

DATA
OUTPUT

- Specially designed for bore gages
- The minimum value tracking function can find the diameter automatically
- Read the diameter directly, after inputting the size of setting ring
- Reading in digital and analog
- Display can be rotated by 320°
- Button function: minimum value tracking, calibration, data preset, inch/metric conversion, absolute/incremental measurement
- CR2032 battery, automatic power off
- Data output
- Optional accessory: data output cable (code 7306-40, 7302-SPC3A, 7305-SPC1A), backs (page 104~105), contact points (page 102~103)

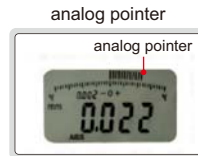

2108-10F

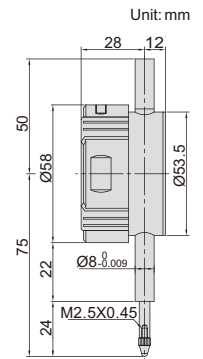

Code	Range	Resolution	Accuracy	Hysteresis	Remark
2108-10F*	12.7mm/0.5"	0.002mm/0.0001"	20µm	10µm	flat back
2108-101F*	12.7mm/0.5"	0.001mm/0.00005"	5µm	2µm	flat back

* Supplied with manufacturer inspection certificate traceable to NIST USA



DIGITAL INDICATORS WITH LIFTING LEVER

DATA OUTPUT

- Reading in digital and analog
- Display can be rotated by 320°
- Button function: tolerance Go and No-Go display, data preset, measuring direction change, max./min./TIR measurement, inch/metric conversion, absolute/incremental measurement
- CR2032 battery, automatic power off
- Data output
- Optional accessory: data output cable (code **7306-40**, **7302-SPC3A**, **7305-SPC1A**), backs (page 104~105), contact points (page 102~103)



2109-10

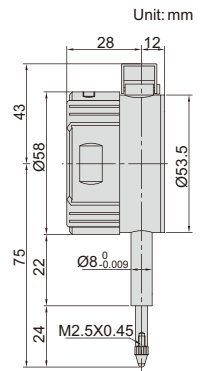

Code	Range	Resolution	Accuracy	Hysteresis	Remark
2109-10*	10mm/0.4"	0.01mm/0.0005"	20µm	10µm	flat back
2109-101*	10mm/0.4"	0.001mm/0.00005"	5µm	2µm	flat back

* Supplied with manufacturer inspection certificate traceable to NIST USA



BACK PLUNGER TYPE DIGITAL INDICATORS



2118-10

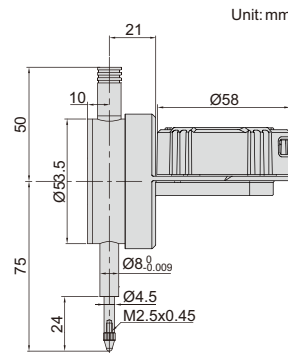

DATA OUTPUT

- Display can rotate 320°, and display direction is changeable
- Reading in digital and analog
- Button function: tolerance Go and No-Go display, data preset, measuring direction change, max./min./TIR measurement, inch/metric conversion, absolute/incremental measurement
- CR2032 battery, automatic power off
- Data output
- Optional accessory: data output cable (code **7306-40**, **7302-SPC3A**, **7305-SPC1A**), backs (page 104~105), contact points (page 102~103)

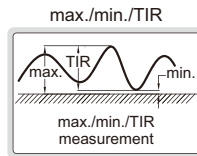

spindle lift knob is included



analog pointer



display can rotate 320°



display direction is changeable

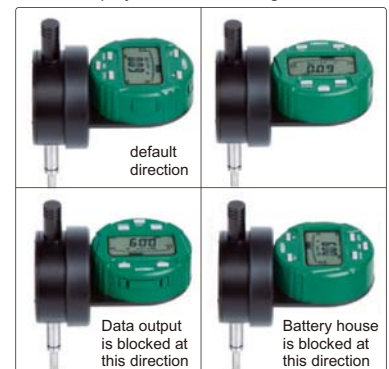

Code	Range	Resolution	Accuracy	Hysteresis	Remark
2118-10*	12.7mm/0.5"	0.01mm/0.0005"	20µm	10µm	flat back
2118-101*	12.7mm/0.5"	0.001mm/0.00005"	5µm	2µm	flat back

* Supplied with manufacturer inspection certificate traceable to NIST USA

Remark: To change above direction, 4 fixing screws on the back of display need to be removed first.

LARGE STROKE DIGITAL INDICATORS

spindle lift knob is included



- Button function: on/off, zero, mm/inch
- CR2032 battery, automatic power off
- Data output
- Optional accessory: data output cable (code **7306-40, 7302-SPC3A, 7305-SPC1A**), backs (page 104~105), contact points (page 102~103)

Resolution 0.01mm/0.0005"

Code	Range	Accuracy	Hysteresis	Remark
2117-100	100mm/4"	30µm	10µm	lug back

Resolution 0.001mm/0.00005"

Code	Range	Accuracy	Hysteresis	Remark
2117-1001	100mm/4"	9µm	3µm	lug back



2117-100

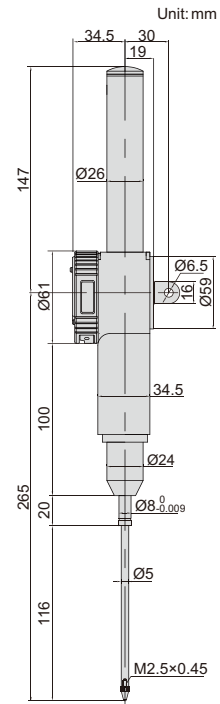

DATA OUTPUT

DIAL COMPARATOR

INSPECTION CERTIFICATE
TRACEABLE TO NIST



- Meet DIN879-1
- Shockproof
- Jeweled bearing
- Overtravel: 3mm
- Shadow free dial face cover
- Supplied with limit pointers
- Initial measuring force 1.2N
- Optional accessory: lifting lever (code **6289-150**)

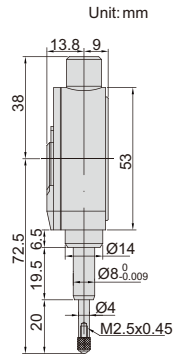

2881-01

JEWELLED BEARING

SHOCK PROOF

lever construction

within the measuring range, the spindle is in contact with the lever



when the measuring range is exceeded, the spindle leaves the lever



lifting lever (optional)

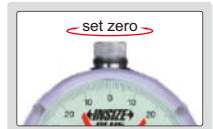

Code	Range	Graduation	Accuracy	Hysteresis	Dial reading	Remark
2881-01*	0.1mm	0.001mm	1.2µm	0.5µm	50-0-50	flat back

* Supplied with manufacturer inspection certificate traceable to NIST USA

HIGH PRECISION COMPACT DIAL INDICATORS

INSPECTION CERTIFICATE
TRACEABLE TO NIST



- Shockproof
- Jeweled bearing
- With limit pointers
- Optional accessory: backs (page 104~105), contact points (page 102~103), lifting lever (code **6289-150**)

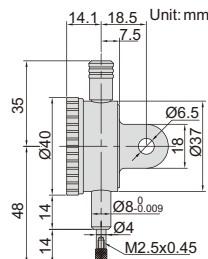

2890-1

SHOCK PROOF

lifting lever (optional)



lever device



Within the measuring range, the spindle is in contact with the lever



When the measuring range is exceeded, the spindle leaves the lever

Code	Range	Graduation	Accuracy	Hysteresis	Range/rev	Dial reading	Remark
2890-1*	1mm	0.001mm	3µm	1.5µm	0.1mm	0-100	lug back
2890-1F*	1mm	0.001mm	3µm	1.5µm	0.1mm	0-100	flat back

* Supplied with manufacturer inspection certificate traceable to NIST USA

HIGH PRECISION DIAL INDICATORS



- Shockproof
- Jeweled bearing
- With limit pointers
- Optional accessory: backs (page 104~105), contact points (page 102~103), lifting lever (code 6289-150)



2891-1

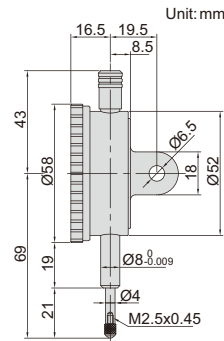

SHOCK PROOF

INSPECTION CERTIFICATE TRACEABLE TO NIST

lifting lever (optional)



lever device

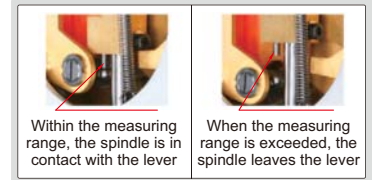

Code	Range	Graduation	Accuracy	Hysteresis	Range/rev	Dial reading	Remark
2891-1*	1mm	0.001mm	3µm	1.5µm	0.1mm	0-100	lug back
2891-1F*	1mm	0.001mm	3µm	1.5µm	0.1mm	0-100	flat back

* Supplied with manufacturer inspection certificate traceable to NIST USA

PRECISION DIAL INDICATORS



- Shockproof
- Jeweled bearing
- With limit pointers
- Optional accessory: backs (page 104~105), contact points (page 102~103)



2830-1

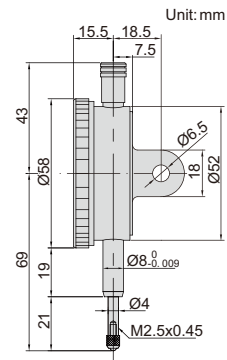

JEWELLED BEARING

SHOCK PROOF

Code	Range	Graduation	Accuracy	Hysteresis	Range/rev	Dial reading	Remark
2830-1*	1mm	0.001mm	5µm	2µm	0.2mm	0-100-0	lug back
2830-1F*	1mm	0.001mm	5µm	2µm	0.2mm	0-100-0	flat back

* Supplied with manufacturer inspection certificate traceable to NIST USA

COMPACT DIAL INDICATOR



- Meet DIN878
- With limit pointers
- Optional accessory: backs (page 104~105), contact points (page 102~103)



2886-3F

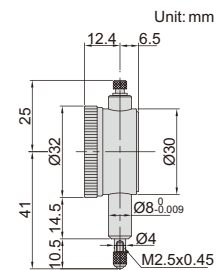

Code	Range	Graduation	Accuracy	Hysteresis	Range/rev	Dial reading	Remark
2886-3F*	3mm	0.01mm	12µm	3µm	0.5mm	0-50	flat back

* Supplied with manufacturer inspection certificate traceable to NIST USA

COMPACT DIAL INDICATORS



- Meet DIN878
- With limit pointers
- Optional accessory: backs (page 104~105), contact points (page 102~103)



2887-5

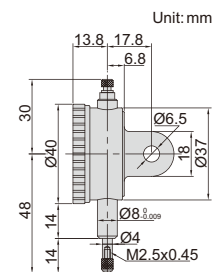

Code	Range	Graduation	Accuracy	Hysteresis	Range/rev	Dial reading	Remark
2887-5*	5mm	0.01mm	14µm	3µm	0.5mm	0-50	lug back
2887-5F*	5mm	0.01mm	14µm	3µm	0.5mm	0-50	flat back

* Supplied with manufacturer inspection certificate traceable to NIST USA

LARGE DIAL FACE DIAL INDICATOR

INSPECTION CERTIFICATE
TRACEABLE TO NIST

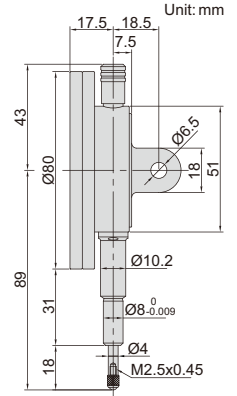

2888-10

- Large, easy-to-read dial face
- With limit pointers
- Optional accessory: backs (page 104~105), contact points (page 102~103)

Code	Range	Graduation	Accuracy	Hysteresis	Range/rev	Dial reading	Remark
2888-10 *	10mm	0.01mm	17µm	5µm	1mm	0-100	flat back, with spare lug back

* Supplied with manufacturer inspection certificate traceable to NIST USA

DIAL INDICATORS

INSPECTION CERTIFICATE
TRACEABLE TO NIST

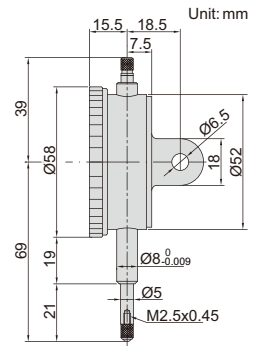

2892-10

- Meet DIN878
- With limit pointers
- Optional accessory: backs (page 104~105), contact points (page 102~103)

Code	Range	Graduation	Accuracy	Hysteresis	Range/rev	Dial reading	Remark
2892-10 *	10mm	0.01mm	17µm	3µm	1mm	0-100	lug back
2892-10F *	10mm	0.01mm	17µm	3µm	1mm	0-100	flat back

* Supplied with manufacturer inspection certificate traceable to NIST USA

BACK PLUNGER DIAL INDICATOR

INSPECTION CERTIFICATE
TRACEABLE TO NIST

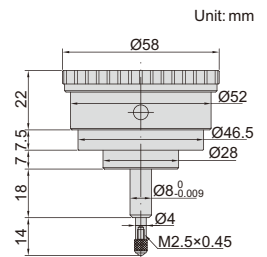

2893-3

- With limit pointers
- Optional accessory: contact points (page 102~103)

Code	Range	Graduation	Accuracy	Hysteresis	Range/rev	Dial reading
2893-3 *	3mm	0.01mm	15µm	5µm	1mm	0-100

* Supplied with manufacturer inspection certificate traceable to NIST USA

WATERPROOF DIAL INDICATOR

INSPECTION CERTIFICATE
TRACEABLE TO NIST

SHOCK PROOF

IP67 WATERPROOF

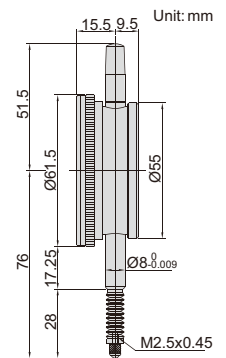

2894-10F

- Meet DIN878
- Shockproof
- IP67 dust/waterproof
- Optional accessory: contact points (page 102~103)

Code	Range	Graduation	Accuracy	Hysteresis	Range/rev	Dial reading	Remark
2894-10F *	10mm	0.01mm	17µm	3µm	1mm	0-100	flat back

* Supplied with manufacturer inspection certificate traceable to NIST USA



INSPECTION CERTIFICATE
TRACEABLE TO NIST

DIAL INDICATORS (LONG STROKE)



2889-30

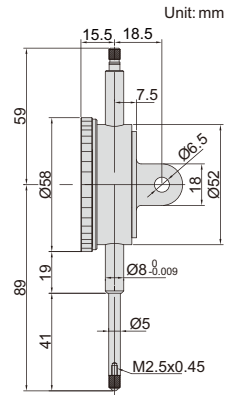

- With limit pointers
- Optional accessory: backs (page 104~105), contact points (page 102~103)

Code	Range	Graduation	Accuracy	Hysteresis	Range/rev	Dial reading	Remark
2889-30 *	30mm	0.01mm	25µm	5µm	1mm	0-100	lug back
2889-30F *	30mm	0.01mm	25µm	5µm	1mm	0-100	flat back

* Supplied with manufacturer inspection certificate traceable to NIST USA

INSPECTION CERTIFICATE
TRACEABLE TO NIST

SHOCK PROOF

ONE REVOLUTION PRECISION DIAL INDICATORS



lifting lever (optional)

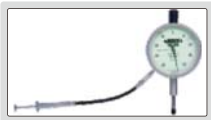

2885-008

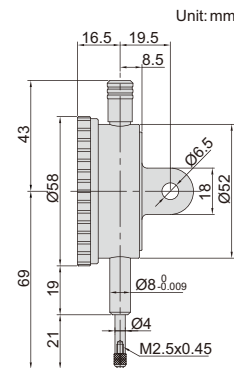

- Eliminate the possibility of reading errors due to miscounting
- Shockproof
- Jeweled bearing
- Free stroke: 4.5mm
- With limit pointers
- Optional accessory: backs (page 104~105), contact points (page 102~103), lifting lever (code 6289-150)

Code	Range	Graduation	Accuracy	Hysteresis	Range/rev	Dial reading	Remark
2885-008 *	0.08mm	0.001mm	3µm	1.5µm	1mm	40-0-40	lug back
2885-008F *	0.08mm	0.001mm	3µm	1.5µm	1mm	40-0-40	flat back

* Supplied with manufacturer inspection certificate traceable to NIST USA

lever device



Within the measuring range, the spindle is in contact with the lever



When the measuring range is exceeded, the spindle leaves the lever

INSPECTION CERTIFICATE
TRACEABLE TO NIST

SHOCK PROOF

ONE REVOLUTION DIAL INDICATORS



2882-08

- Meet DIN878
- Eliminate the possibility of reading errors due to miscounting
- Shockproof
- Free stroke: 7mm
- With limit pointers
- Optional accessory: backs (page 104~105), contact points (page 102~103)

Code	Range	Graduation	Accuracy	Hysteresis	Range/rev	Dial reading	Remark
2882-08 *	0.8mm	0.01mm	9µm	3µm	1mm	40-0-40	lug back
2882-08F *	0.8mm	0.01mm	9µm	3µm	1mm	40-0-40	flat back

* Supplied with manufacturer inspection certificate traceable to NIST USA

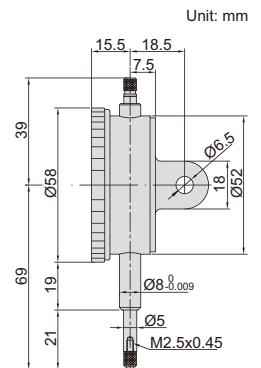

PRECISION DIAL INDICATORS

INSPECTION CERTIFICATE
TRACEABLE TO NIST

JEWELLED BEARING



2313-1A

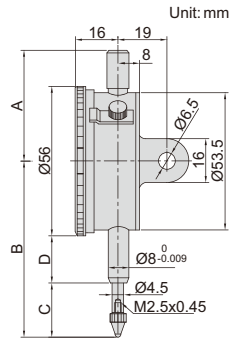

- Graduation: 0.001mm
- Jeweled bearing
- Supplied with limit pointers and bezel clamp
- Optional accessory: backs (page 104~105), contact points (page 102~103)

(mm)

Code	Range	Accuracy	Hysteresis	Range/rev	Dial reading	Remark	A	B	C	D
2313-1FA *	1mm	5µm	2µm	0.2mm	0-100-0	flat back	45	62.5	19.5	15
2313-2FA *	2mm	8µm	2.5µm	0.2mm	0-100-0	flat back	45	62.5	19.5	15
2313-1A *	1mm	5µm	2µm	0.2mm	0-100-0	lug back	45	62.5	19.5	15
2313-2A *	2mm	8µm	2.5µm	0.2mm	0-100-0	lug back	45	62.5	19.5	15

* Supplied with manufacturer inspection certificate traceable to NIST USA

COMPACT DIAL INDICATORS

INSPECTION CERTIFICATE
TRACEABLE TO NIST

JEWELLED BEARING



2311-5

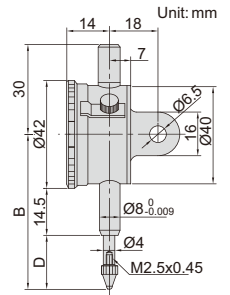

- Meet DIN878
- Jeweled bearing
- Supplied with limit pointers and bezel clamp
- Optional accessory: backs (page 104~105), contact points (page 102~103)

(mm)

Code	Range	Graduation	Accuracy	Hysteresis	Range/rev	Dial reading	Remark	B	D
2311-3F *	3mm	0.01mm	14µm	3µm	0.5mm	0-50	flat back	46	10.5
2311-5F *	5mm	0.01mm	16µm	3µm	0.5mm	0-50	flat back	48	12.5
2311-3 *	3mm	0.01mm	14µm	3µm	0.5mm	0-50	lug back	46	10.5
2311-5 *	5mm	0.01mm	16µm	3µm	0.5mm	0-50	lug back	48	12.5

* Supplied with manufacturer inspection certificate traceable to NIST USA

DIAL INDICATORS (PROMOTION MODEL)

INSPECTION CERTIFICATE
TRACEABLE TO NIST

carton box



2301-10

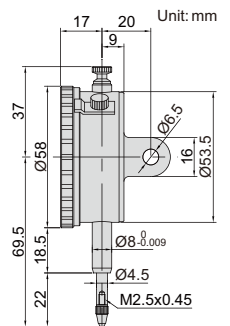

- Meet DIN878
- Jeweled bearing
- Supplied with limit hands and bezel clamp
- Packed in carton box
- Optional accessory: backs (page 104~105), contact points (page 102~103)

Code	Range	Graduation	Accuracy	Hysteresis	Range/rev	Dial reading	Remark
2301-10F *	10mm	0.01mm	17µm	3µm	1mm	0-100	flat back
2301-10 *	10mm	0.01mm	17µm	3µm	1mm	0-100	lug back with spare flat back

* Supplied with manufacturer inspection certificate traceable to NIST USA

**INSPECTION
CERTIFICATE**
TRACEABLE TO NIST

**JEWELLED
BEARING**

DIAL INDICATORS (STANDARD MODEL)



2308-10A

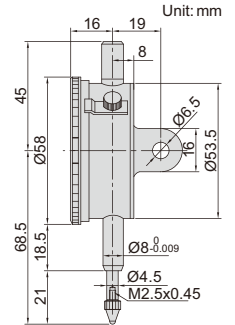

- Meet DIN878
- Jeweled bearing
- Supplied with limit pointers and bezel clamp
- Optional accessory: backs (page 104~105), contact points (page 102~103)

Code	Range	Graduation	Accuracy	Hysteresis	Range/rev	Dial reading	Remark
2308-3FA *	3mm	0.01mm	14µm	3µm	1mm	0-100	flat back
2308-5FA *	5mm	0.01mm	16µm	3µm	1mm	0-100	flat back
2308-10FA *	10mm	0.01mm	17µm	3µm	1mm	0-100	flat back
2308-3A *	3mm	0.01mm	14µm	3µm	1mm	0-100	lug back
2308-5A *	5mm	0.01mm	16µm	3µm	1mm	0-100	lug back
2308-10A *	10mm	0.01mm	17µm	3µm	1mm	0-100	lug back

* Supplied with manufacturer inspection certificate traceable to NIST USA

**INSPECTION
CERTIFICATE**
TRACEABLE TO NIST

**JEWELLED
BEARING**

REVERSE READING DIAL INDICATORS



2801-10

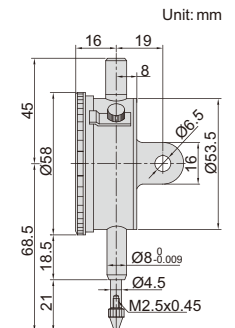

- Meet DIN878
- Suitable for depth and step measurements
- Jeweled bearing
- Supplied with limit pointers and bezel clamp
- Optional accessory: backs (page 104~105), contact points (page 102~103)

Code	Range	Graduation	Accuracy	Hysteresis	Range/rev	Dial reading	Remark
2801-10F *	10mm	0.01mm	17µm	3µm	1mm	100-0	flat back
2801-10 *	10mm	0.01mm	17µm	3µm	1mm	100-0	lug back

* Supplied with manufacturer inspection certificate traceable to NIST USA

**INSPECTION
CERTIFICATE**
TRACEABLE TO NIST

**SHOCK
PROOF**

**JEWELLED
BEARING**

SHOCKPROOF DIAL INDICATORS



2314-10A

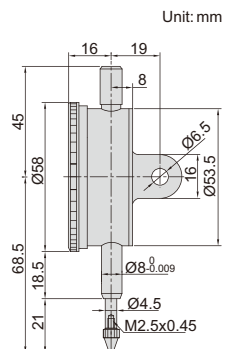

- Meet DIN878
- Shockproof
- Jeweled bearing
- Supplied with limit pointers and bezel clamp
- Optional accessory: backs (page 104~105), contact points (page 102~103)

Code	Range	Graduation	Accuracy	Hysteresis	Range/rev	Dial reading	Remark
2314-3FA *	3mm	0.01mm	14µm	3µm	1mm	0-100	flat back
2314-5FA *	5mm	0.01mm	16µm	3µm	1mm	0-100	flat back
2314-10FA *	10mm	0.01mm	20µm	3µm	1mm	0-100	flat back
2314-3A *	3mm	0.01mm	14µm	3µm	1mm	0-100	lug back
2314-5A *	5mm	0.01mm	16µm	3µm	1mm	0-100	lug back
2314-10A *	10mm	0.01mm	20µm	3µm	1mm	0-100	lug back

* Supplied with manufacturer inspection certificate traceable to NIST USA

BACK PLUNGER TYPE DIAL INDICATORS

**INSPECTION
CERTIFICATE**
TRACEABLE TO NIST



2357-5

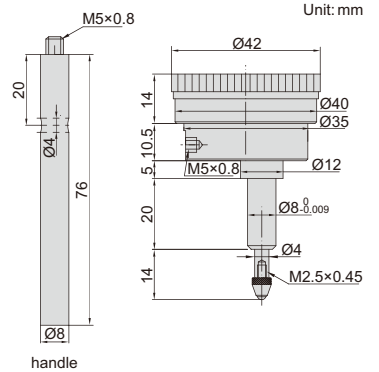

- Supplied with handle
- With limit pointers
- Optional accessory: contact points (page 102~103)

Code	Range	Graduation	Accuracy	Hysteresis	Range/rev	Dial reading
2357-5*	5mm	0.01mm	15µm	5µm	1mm	0-100

* Supplied with manufacturer inspection certificate traceable to NIST USA

WATERPROOF DIAL INDICATORS

**IP54
WATERPROOF**

**JEWELLED
BEARING**

**INSPECTION
CERTIFICATE**
TRACEABLE TO NIST



2324-10

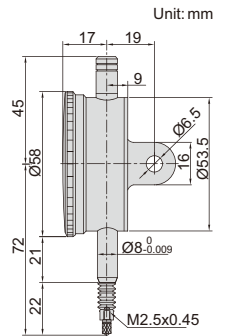

- Meet DIN878
- IP54 dust/waterproof
- Jeweled bearing

Code	Range	Graduation	Accuracy	Hysteresis	Range/rev	Dial reading	Remark
2324-10F*	10mm	0.01mm	17µm	3µm	1mm	0-100	flat back
2324-10*	10mm	0.01mm	17µm	3µm	1mm	0-100	lug back

* Supplied with manufacturer inspection certificate traceable to NIST USA

DOUBLE FACE DIAL INDICATOR

**INSPECTION
CERTIFICATE**
TRACEABLE TO NIST

- Meet DIN878
- Read from both sides
- Jeweled bearing
- Supplied with limit pointers
- Optional accessory: contact points (page 102~103)



2328-10

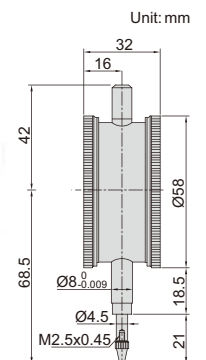

Code	Range	Graduation	Accuracy	Hysteresis	Range/rev	Dial reading
2328-10*	10mm	0.01mm	17µm	3µm	1mm	0-100

* Supplied with manufacturer inspection certificate traceable to NIST USA



DIAL INDICATORS (LONG STROKE)



2310-30A

- Supplied with limit pointers and bezel clamp
- Optional accessory: backs (page 104~105), contact points (page 102~103)

Code	Range	Graduation	Accuracy	Hysteresis	Range/rev	Dial reading	Remark	B	D
2310-20FA*	20mm	0.01mm	25µm	5µm	1mm	0-100	flat back	83	35
2310-30FA*	30mm	0.01mm	35µm	7µm	1mm	0-100	flat back	88	40
2310-20A*	20mm	0.01mm	25µm	5µm	1mm	0-100	lug back	83	35
2310-30A*	30mm	0.01mm	35µm	7µm	1mm	0-100	lug back	88	40

* Supplied with manufacturer inspection certificate traceable to NIST USA

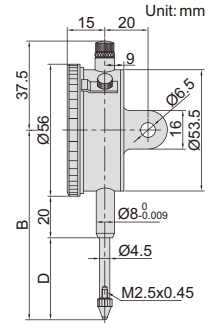

DIAL INDICATORS (LONG STROKE)



2302-25

carton box



- Supplied with limit pointers and bezel clamp
- Packed in carton box
- Optional accessory: backs (page 104~105), contact points (page 102~103)

Code	Range	Graduation	Accuracy	Hysteresis	Range/rev	Dial reading	Remark
2302-25F*	25mm	0.01mm	35µm	7µm	1mm	0-100	flat back
2302-25*	25mm	0.01mm	35µm	7µm	1mm	0-100	lug back with spare flat back

* Supplied with manufacturer inspection certificate traceable to NIST USA

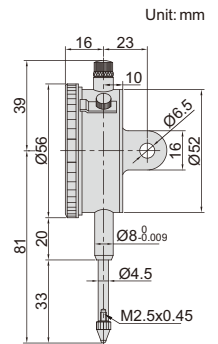

DIAL INDICATORS (GRADUATION 0.1mm)



2318-30

- Supplied with limit pointers and bezel clamp
- Optional accessory: backs (page 104~105), contact points (page 102~103)

Code	Range	Graduation	Accuracy	Hysteresis	Range/rev	Dial reading	Remark	B	D
2318-10F	10mm	0.1mm	40µm	20µm	10mm	0-10	flat back	70	20
2318-20F	20mm	0.1mm	50µm	20µm	10mm	0-10	flat back	85	35
2318-25F	25mm	0.1mm	60µm	20µm	10mm	0-10	flat back	85	35
2318-30F	30mm	0.1mm	60µm	20µm	10mm	0-10	flat back	90	40
2318-10	10mm	0.1mm	40µm	20µm	10mm	0-10	lug back	70	20
2318-20	20mm	0.1mm	50µm	20µm	10mm	0-10	lug back	85	35
2318-25	25mm	0.1mm	60µm	20µm	10mm	0-10	lug back	85	35
2318-30	30mm	0.1mm	60µm	20µm	10mm	0-10	lug back	90	40

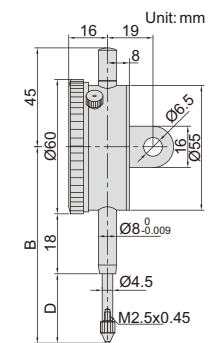

ONE REVOLUTION DIAL INDICATORS

SHOCK PROOF

INSPECTION CERTIFICATE
TRACEABLE TO NIST

- Meet DIN878
- Eliminate the possibility of reading errors due to miscounting
- Shockproof
- Supplied with limit pointers
- Optional accessory: backs (page 104~105), contact points (page 102~103)



2316-05

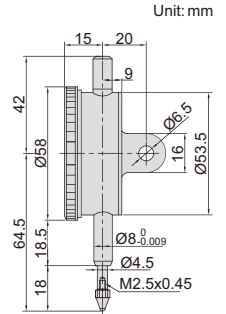

Unit: mm

Code	Range	Graduation	Accuracy	Hysteresis	Dial reading	Remark
2316-05F *	0.5mm	0.01mm	9μm	3μm	25-0-25	flat back
2316-1F *	1mm	0.01mm	9μm	3μm	50-0-50	flat back
2316-05 *	0.5mm	0.01mm	9μm	3μm	25-0-25	lug back
2316-1 *	1mm	0.01mm	9μm	3μm	50-0-50	lug back

* Supplied with manufacturer inspection certificate traceable to NIST USA

DIAL INDICATORS (LONG STROKE)

INSPECTION CERTIFICATE
TRACEABLE TO NIST

JEWELLED BEARING

SHOCK PROOF

- Shockproof
- Jeweled bearing
- Supplied with limit pointers
- Optional accessory: backs (page 104~105), contact points (page 102~103)



2309-50

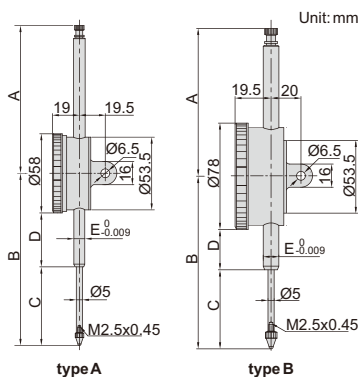

Unit: mm

type A

type B

back of type B



stem clamp Ø10mm for 2309-100D



Code	Type	A	B	C	D	E
2309-30F	A	37.5	89.5	40.9	19.5	Ø8
2309-30	A	37.5	89.5	40.9	19.5	Ø8
2309-50	A	108.3	126.2	57.7	39.5	Ø8
2309-50D	B	108.3	126.2	57.7	29.5	Ø8
2309-80	A	138.4	168.4	88	51.3	Ø8
2309-80D	B	138.4	168.4	88	41.3	Ø8
2309-100D	B	167.6	207.8	108	60.8	Ø10

Code	Range	Graduation	Type	Accuracy	Hysteresis	Range/rev	Dial reading	Remark
2309-30F *	30mm	0.01mm	A	35μm	7μm	1mm	0-100	flat back
2309-30 *	30mm	0.01mm	A	35μm	7μm	1mm	0-100	lug back
2309-50 *	50mm	0.01mm	A	40μm	8μm	1mm	0-100	flat back with spare lug back
2309-50D *	50mm	0.01mm	B	40μm	8μm	1mm	0-100	flat back with spare lug back
2309-80	80mm	0.01mm	A	50μm	9μm	1mm	0-100	flat back with spare lug back
2309-80D	80mm	0.01mm	B	50μm	9μm	1mm	0-100	flat back with spare lug back
2309-100D	100mm	0.01mm	B	50μm	9μm	1mm	0-100	flat back with spare lug back

Note: 1) 2309-80, 2309-80D and 2309-100D can only be used vertically
 2) 2309-100D is supplied with stem clamp Ø10mm for magnetic stands (code 6200-60, 6201-60, 6202-80, 6202-100)
 3) 2309-30 and 2309-30F can not accept optional backs (page 104~105)

* Supplied with manufacturer inspection certificate traceable to NIST USA

BALL POINTS

Code	Material of measuring face	L (mm)	Code	Material of measuring face	L (mm)	Code	Material of measuring face	L (mm)
6282-0101	carbide	7.3	6282-0109	ceramic	15	6282-0115	carbide	25
6282-0103	ceramic	7.3	6282-0110	carbide	17	6282-0116	ceramic	25
6282-0104	carbide	8.3	6282-0111	carbide	19.3	6282-0117	carbide	30
6282-0106	carbide	12.1	6282-0112	carbide	20	6282-0118	ceramic	30
6282-0107	carbide	14	6282-0113	ceramic	20			
6282-0108	carbide	15	6282-0114	carbide	22			

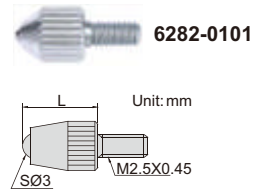

Code	Material of measuring face	SØD (mm)	Code	Material of measuring face	SØD (mm)
6282-0301	steel	1	6282-0304	carbide	2.5
6282-0302	carbide	1.5	6282-0305	carbide	4
6282-0303	carbide	1.8			

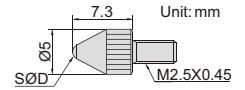

Code	Material of measuring face	L (mm)	Code	Material of measuring face	L (mm)
6282-0202	steel	5	6282-0207	steel	20
6282-0203	steel	10	6282-0208	steel	25
6282-0205	steel	15	6282-0210	steel	30

SHELL TYPE POINTS

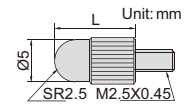

Code	Material of measuring face
6282-0401	steel



6282-0401

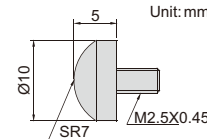

SPHERICAL POINT

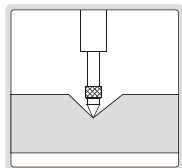

Code	Material of measuring face
6282-0601	steel
6282-0701	steel
6282-0801	steel
6282-0901	steel

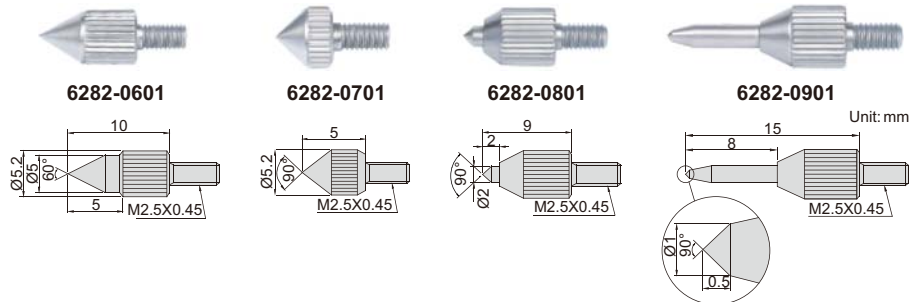

CONICAL POINTS

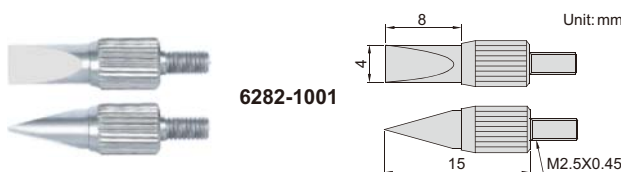
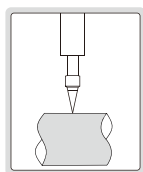

6282-1001

KNIFE EDGE POINT

Code	Material of measuring face
6282-1001	steel

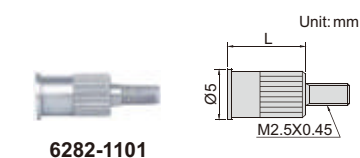

6282-1101

Code	Material of measuring face	L (mm)
6282-1101	steel	8
6282-1102	steel	10

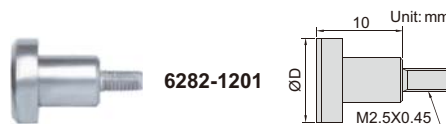

6282-1201

Code	Material of measuring face	ØD (mm)
6282-1201	steel	10
6282-1202	steel	15
6282-1203	steel	20
6282-1204	steel	25
6282-1205	steel	30

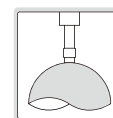

6282-1301

Code	Material of measuring face
6282-1301	carbide

FLAT POINTS

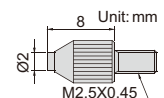

NEEDLE POINTS

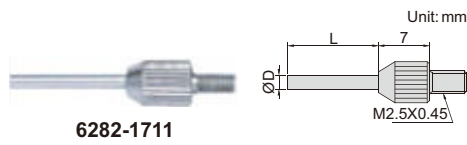

6282-1711

Code	Material of measuring face	ØD	L
6282-1701	steel	0.45	3
6282-1702	steel	0.45	5
6282-1703	carbide	1	3
6282-1704	carbide	1	5
6282-1705	carbide	1	8
6282-1706	carbide	1	10
6282-1707	carbide	1	20
6282-1708	carbide	1	40
6282-1709	carbide	1.5	5

Code	Material of measuring face	ØD	L
6282-1710	carbide	1.5	10
6282-1711	carbide	1.5	13
6282-1712	carbide	1.5	20
6282-1713	carbide	1.5	40
6282-1714	carbide	2	8
6282-1715	carbide	2	18
6282-1716	carbide	2	28
6282-1717	carbide	2	40

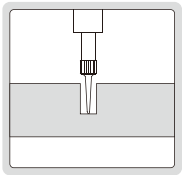

6282-1601

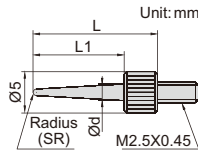

Code	Material of measuring face	L1	L	SR	Ød
6282-1601	steel	11	15	0.4	2
6282-1602	steel	13	17	0.2	2
6282-1603	steel	21	25	0.4	3
6282-1604	steel	31	35	0.4	3

BLADE POINTS

Code	Material of measuring face	D	W
6282-1801	steel	0.4	2
6282-1802	steel	0.6	2
6282-1803	steel	1	4

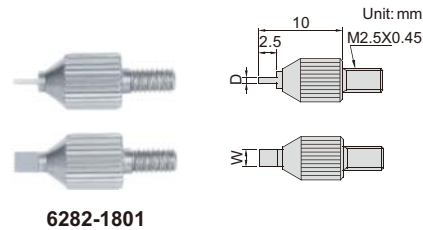

6282-1801

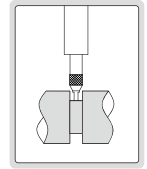

ROLLER POINT

Code	Material of measuring face
6282-1901	steel

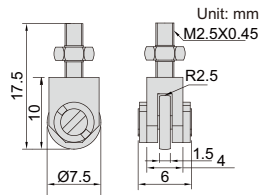

6282-1901

EXTENSION RODS

Code	Material	L (mm)
6282-2001	steel	10
6282-2002	steel	15
6282-2003	steel	20
6282-2004	steel	25
6282-2005	steel	30
6282-2006	steel	35

Code	Material	L (mm)
6282-2007	steel	40
6282-2008	steel	45
6282-2009	steel	50
6282-2010	steel	55
6282-2011	steel	60
6282-2012	steel	65

Code	Material	L (mm)
6282-2013	steel	70
6282-2014	steel	75
6282-2015	steel	80
6282-2016	steel	90
6282-2017	steel	100

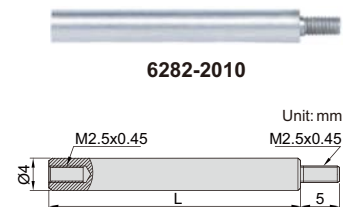

6282-2010

POINT SET

Code	Material of measuring face
6282-S6	steel

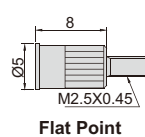

Flat Point

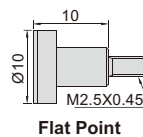

Flat Point

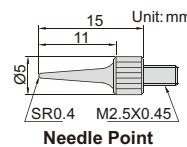

Needle Point

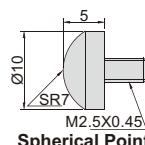

Spherical Point

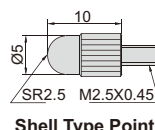

Shell Type Point

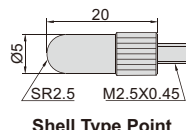

Shell Type Point



6282-S6

LIFTING LEVER



6289-150

Code
6289-150

- The lifting cable permits quick lifting of the spindle of 2881, 2890, 2891, 2885 series

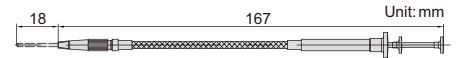

SPINDLE LIFT KNOB



7332



Code
7332

- For dial/digital indicators with spindle diameter Ø4.5mm or Ø5mm

MAGNETIC BACKS

Code	ØD	For digital/dial indicators
7331-M1	51.5	2103
		2104
		2108
		2109
		2112
		2113
		2115
		2116
		2117
		2118
		2301
		2302
		2308
7331-M2	54	2313
		2314
		2316
		2801
		2318



7331-M2

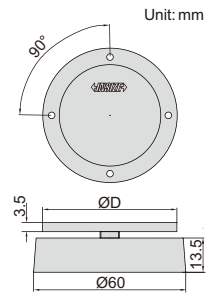

LUG BACKS

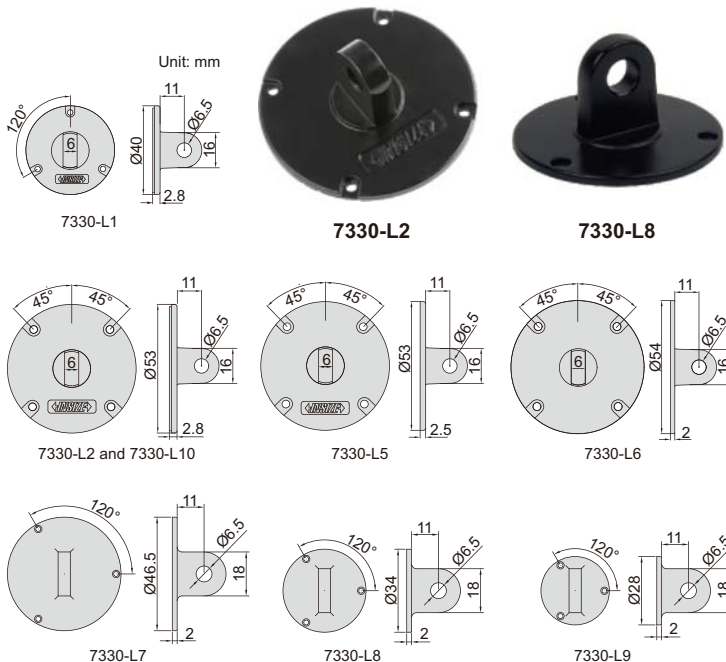

Code	For digital/dial indicators	Code	For digital/dial indicators
7330-L1	2311	7330-L5	2115
	2301		2116
	2302		2117
	2308	2118	
7330-L2	2309 (except 2309-30, 2309-30F)	7330-L6	2318
	2313	7330-L7	2830
	2314		2882
	2316		2885
	2801		2888
			2889
7330-L5	2103	7330-L8	2891
	2104		2892
	2108		2890
	2109	7330-L9	2887
	2112		2886
	2113		2310

FLAT BACKS



Code	For digital/dial indicators	Code	For digital/dial indicators		
7330-F1	2311	7330-F5	2115		
	2301		2116		
	2302		2118		
	2308		7330-F6	2318	
	2309 (except 2309-30, 2309-30F)			2830	
7330-F2	2313	7330-F7	2882		
	2314		2885		
	2316		2888		
	2801		2889		
	2103		2891		
	7330-F5	2104	2892	7330-F8	2890
		2108	2887		
2109		7330-F9	2886		
2112			2310		
2113					

PRECISION DIAL TEST INDICATOR

ANTI MAGNETIC CARBIDE CONTACT POINT



INSPECTION CERTIFICATE
TRACEABLE TO NIST

- Meet DIN2270
- Ceramic bearing
- Anti magnetic carbide contact point
- Two measuring directions
- Supplied with one clamp: diameter Ø8mm
- Optional accessory: styli (page 109)

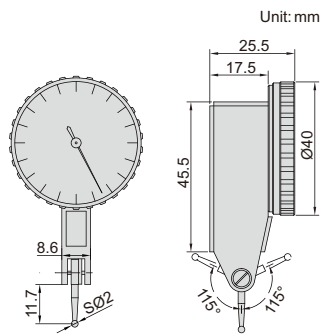

2897-02

clamp (included)

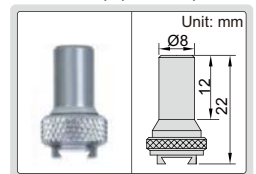

Code	Range	Graduation	Accuracy	Hysteresis	Dial reading
2897-02 *	0.2mm	0.001mm	4µm	2µm	0-100-0

* Supplied with manufacturer inspection certificate traceable to NIST USA

PRECISION DIAL TEST INDICATORS



INSPECTION CERTIFICATE
TRACEABLE TO NIST

- Meet DIN2270
- Ceramic bearing
- Two measuring directions
- Supplied with one clamp: diameter Ø8mm
- Optional accessory: styli (page 109)

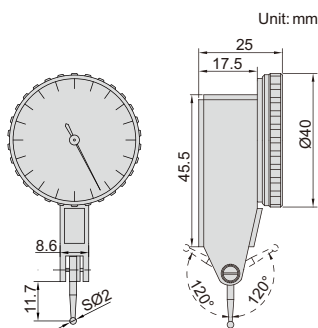

ruby contact point of 2880-02R



2880-02

clamp (included)

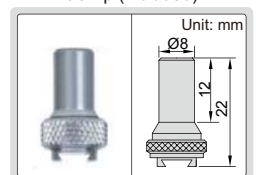

Code	Range	Graduation	Accuracy	Hysteresis	Dial reading	Remark
2880-02 *	0.2mm	0.002mm	4µm	2µm	0-100-0	anti magnetic carbide contact point
2880-02R *	0.2mm	0.002mm	4µm	2µm	0-100-0	ruby contact point

* Supplied with manufacturer inspection certificate traceable to NIST USA



DIAL TEST INDICATOR

ANTI MAGNETIC
CARBIDE CONTACT POINT



2895-08

- Meet DIN2270
- Ceramic bearing
- Anti magnetic carbide contact point
- Two measuring directions
- Supplied with one clamp: diameter Ø8mm
- Optional accessory: styli (page 109)

Code	Range	Graduation	Accuracy	Hysteresis	Dial reading
2895-08*	0.8mm	0.01mm	13µm	3µm	0-40-0

* Supplied with manufacturer inspection certificate traceable to NIST USA

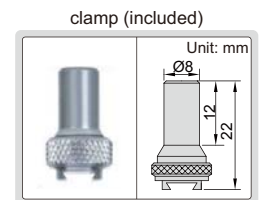
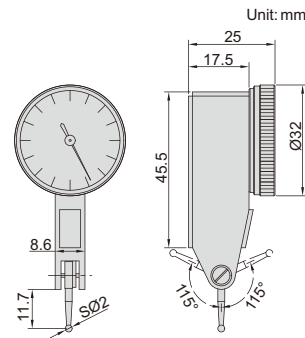

ANTI MAGNETIC
CARBIDE CONTACT POINT

LONG STYLI DIAL TEST INDICATOR



2896-05

- Meet DIN2270
- Ceramic bearing
- Anti magnetic carbide contact point
- Two measuring directions
- Supplied with one clamp: diameter Ø8mm
- Optional accessory: styli (page 109)

Code	Range	Graduation	Accuracy	Hysteresis	Dial reading
2896-05*	0.5mm	0.01mm	13µm	3µm	0-25-0

* Supplied with manufacturer inspection certificate traceable to NIST USA

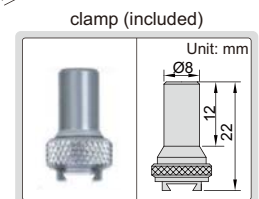
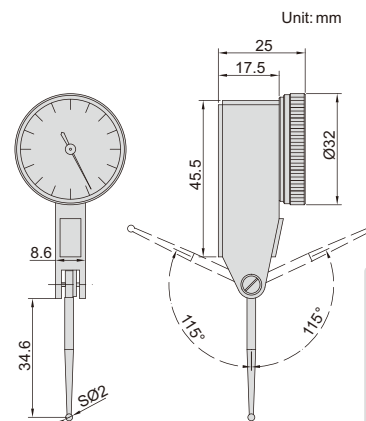

ANTI MAGNETIC
CARBIDE CONTACT POINT

BACK PLUNGER LONG STYLI DIAL TEST INDICATOR



2899-05

- Meet DIN2270
- Ceramic bearing
- Anti magnetic carbide contact point
- Two measuring directions
- Supplied with one clamp: diameter Ø8mm
- Optional accessory: styli (page 109)

Code	Range	Graduation	Accuracy	Hysteresis	Dial reading
2899-05*	0.5mm	0.01mm	13µm	3µm	0-25-0

* Supplied with manufacturer inspection certificate traceable to NIST USA

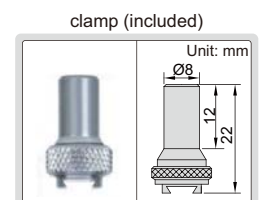
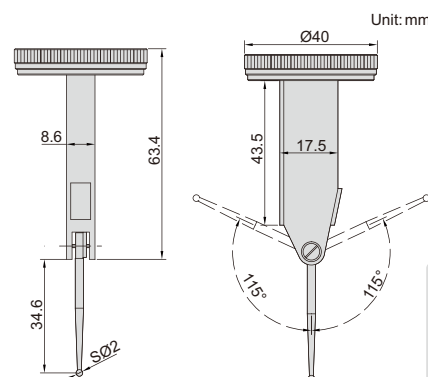

SIDE TYPE DIAL TEST INDICATOR

ANTI MAGNETIC
CARBIDE CONTACT POINT



**INSPECTION
CERTIFICATE**
TRACEABLE TO NIST

- Meet DIN2270
- Ceramic bearing
- Anti magnetic carbide contact point
- Two measuring directions
- Supplied with one clamp: diameter Ø8mm
- Optional accessory: styli (page 109)



2898-08

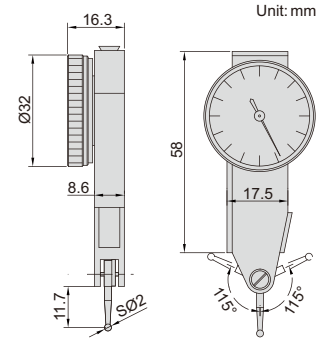
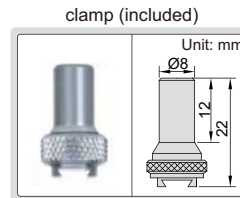

Code	Range	Graduation	Accuracy	Hysteresis	Dial reading
2898-08*	0.8mm	0.01mm	13µm	3µm	0-40-0

* Supplied with manufacturer inspection certificate traceable to NIST USA

DIAL TEST INDICATORS

**INSPECTION
CERTIFICATE**
TRACEABLE TO NIST

JEWELLED
BEARING

- Meet DIN2270 (except 2380-02, 2381-02)
- Jeweled bearing
- Carbide contact point
- Two measuring directions
- Anti magnetic body
- Supplied with two clamps: diameter Ø4mm and Ø8mm
- Optional accessory: styli (page 109)

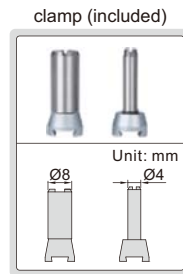

2380-08

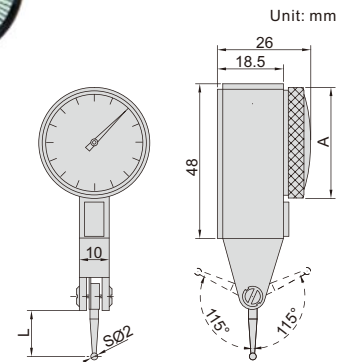

Code	Range	Graduation	Accuracy	Hysteresis	Dial reading	A	L
2380-08*	0.8mm	0.01mm	13µm	3µm	0-40-0	Ø30	13.5
2381-08*	0.8mm	0.01mm	13µm	3µm	0-40-0	Ø37	13.5
2380-02*	0.2mm	0.002mm	6µm	2µm	0-100-0	Ø30	12.5
2381-02*	0.2mm	0.002mm	6µm	2µm	0-100-0	Ø37	12.5

* Supplied with manufacturer inspection certificate traceable to NIST USA

BACK PLUNGER TYPE DIAL TEST INDICATOR

**INSPECTION
CERTIFICATE**
TRACEABLE TO NIST

JEWELLED
BEARING

- Meet DIN2270
- Jeweled bearing
- Carbide contact point
- Two measuring directions
- Anti magnetic body
- Supplied with two clamps: diameter Ø4mm and Ø8mm
- Optional accessory: styli (page 109)

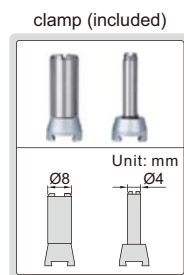

2398-08

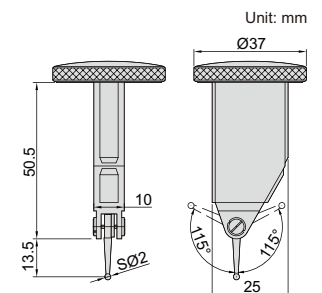

Code	Range	Graduation	Accuracy	Hysteresis	Dial reading
2398-08*	0.8mm	0.01mm	13µm	3µm	0-40-0

* Supplied with manufacturer inspection certificate traceable to NIST USA

**INSPECTION
CERTIFICATE**
TRACEABLE TO NIST

JEWELLED
BEARING

TILTED FACE TYPE DIAL TEST INDICATOR

- Meet DIN2270
- Jeweled bearing
- Carbide contact point
- Two measuring directions
- Anti magnetic body
- Supplied with two clamps:
diameter Ø4mm and Ø8mm
- Optional accessory: styli (page 109)

clamp (included)

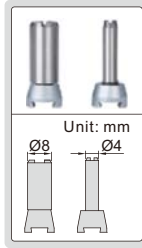

2399-08

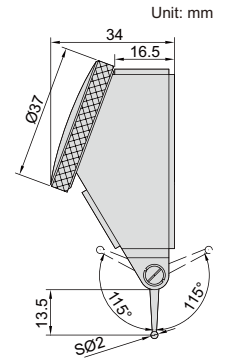

Code	Range	Graduation	Accuracy	Hysteresis	Dial reading
2399-08*	0.8mm	0.01mm	13µm	3µm	0-40-0

* Supplied with manufacturer inspection certificate traceable to NIST USA

**INSPECTION
CERTIFICATE**
TRACEABLE TO NIST

JEWELLED
BEARING

LONG STYLI DIAL TEST INDICATOR

- Meet DIN2270
- Jeweled bearing
- Carbide contact point
- Two measuring directions
- Anti magnetic body
- Supplied with two clamps:
diameter Ø4mm and Ø8mm
- Optional accessory:
styli (page 109)

clamp (included)

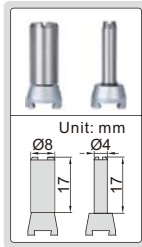

2383-08A

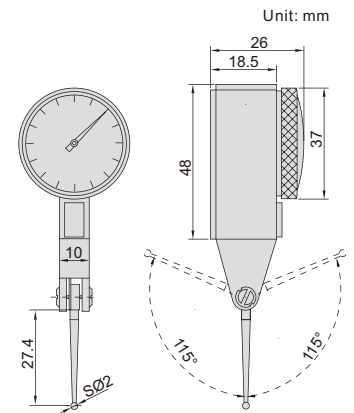

Code	Range	Graduation	Accuracy	Hysteresis	Dial reading
2383-08A*	0.8mm	0.01mm	13µm	3µm	0-40-0

* Supplied with manufacturer inspection certificate traceable to NIST USA

**INSPECTION
CERTIFICATE**
TRACEABLE TO NIST

JEWELLED
BEARING

LARGE RANGE DIAL TEST INDICATOR

- Dial Reading: 0-40-0
- Jeweled bearing
- Carbide contact point
- Two measuring directions
- Anti magnetic body
- Supplied with two clamps:
diameter Ø4mm and Ø8mm
- Optional accessory: styli (page 109)

clamp (included)

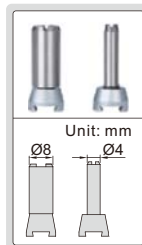

2386-16A

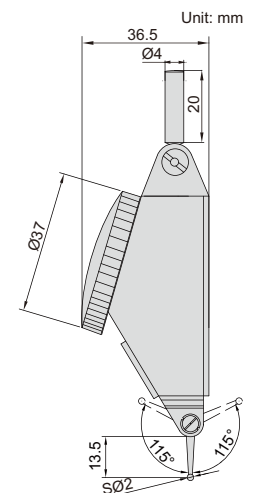

Code	Range	Graduation	Accuracy	Hysteresis
2386-16A*	1.6mm	0.01mm	25µm	8µm

* Supplied with manufacturer inspection certificate traceable to NIST USA

ROUND BODY DIAL TEST INDICATOR

JEWELLED BEARING

INSPECTION CERTIFICATE
TRACEABLE TO NIST

- Meet DIN2270
- Jeweled bearing
- Carbide contact point
- Adjustable two measuring directions
- Anti magnetic body
- Supplied with two clamps: diameter Ø4mm and Ø8mm
- Optional accessory: styli (page 109)

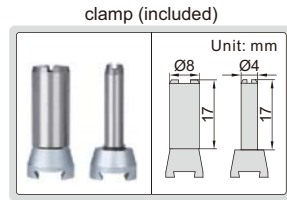

2391-08

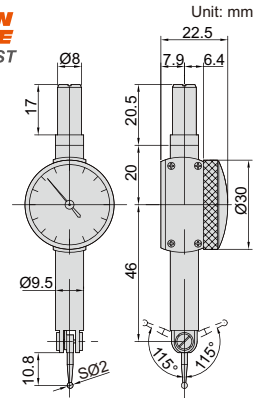

Code	Range	Graduation	Accuracy	Hysteresis	Dial reading
2391-08 *	0.8mm	0.01mm	13µm	3µm	0-40-0

* Supplied with manufacturer inspection certificate traceable to NIST USA

CLAMPS FOR DIAL TEST INDICATORS

Code	ØD
6298-1	Ø4mm
6298-2	Ø8mm

6298-1



6298-2

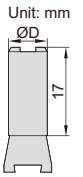

STYLI FOR DIAL TEST INDICATORS



6284-3

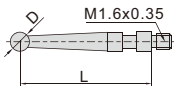

Code	For dial test indicator	Material of contact point	L (mm)	D (mm)
6284-1	2380-08,	steel	13.5	SØ1
6284-3	2398-08	carbide	13.5	SØ2
6284-4	2381-08,	ruby	13.5	SØ2
6284-8	2399-08	carbide	13.5	SØ3
6284-21	2380-02	steel	12.5	SØ1
6284-22	2381-02	carbide	12.5	SØ2
6284-23		carbide	12.5	SØ3
6284-44	2880-02	carbide	11.7	SØ0.4
6284-41	2880-02R	carbide	11.7	SØ1
6284-42	2895-08	carbide	11.7	SØ2
6284-45	2897-02	ruby	11.7	SØ2
6284-43	2898-08	carbide	11.7	SØ3
6284-71	2391-08	carbide	10.8	SØ2

Code	For dial test indicator	Material of contact point	L (mm)	D (mm)
6284-51		carbide	34.6	SØ1
6284-52	2896-05	carbide	34.6	SØ2
6284-55	2899-05	ruby	34.6	SØ2
6284-53		carbide	34.6	SØ3
6284-61		steel	13.5	SØ1
6284-62	2386-16A	carbide	13.5	SØ2
6284-63		ruby	13.5	SØ2
6284-64		carbide	13.5	SØ3
6284-81		steel	27.4	SØ1
6284-82	2383-08A	carbide	27.4	SØ2
6284-83		ruby	27.4	SØ2
6284-84		carbide	27.4	SØ3

DIAL TEST INDICATOR UNIVERSAL HOLDER

- Set the indicators at the desired attitude to the workpiece

Code
6297-1



6297-1

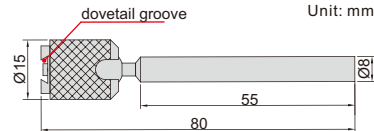

DIAL TEST INDICATOR HOLDER

- Supplied with hex key

Code
6296-1



6296-1

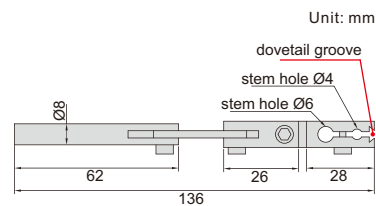

DIAL TEST INDICATOR HOLDERS



6293-1



6293-2

Unit: mm

Code	Stem section	Stem length (L)
6293-1	9x9mm	100mm
6293-6	9x9mm	50mm
6293-2	Ø8mm	115mm

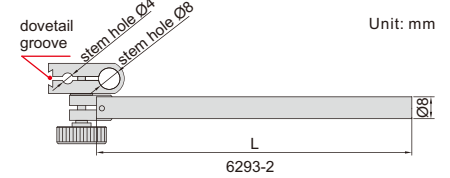
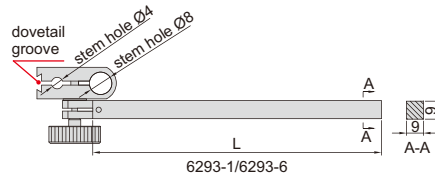

- Center cylinders or holes on machine tools

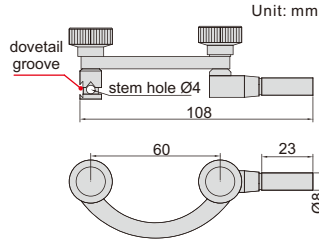

Unit: mm

Code
6291-1

DIAL TEST INDICATOR CENTERING HOLDER



6291-1

ATTENTION: NOT SUITABLE FOR GAGES WITH GRADUATION 0.001MM

- To calibrate dial indicators, test indicators and dial bore gages
- Dimension: 270x210x205mm
- Weight: 11kg



DIAL GAGE TESTER CODE 2396-25A

Micrometer head

Range	Sampling interval	Accuracy	Hysteresis
0-25mm	0.1mm	4µm (0-25mm), 3µm (0-10mm), 2µm (0-1mm)	1µm

Force gage

Range	Graduation	Accuracy
0-1.6N	0.05N	±5% (of load capacity)

Platform

Diameter	Flatness	Roughness
50mm	1µm	0.05µm

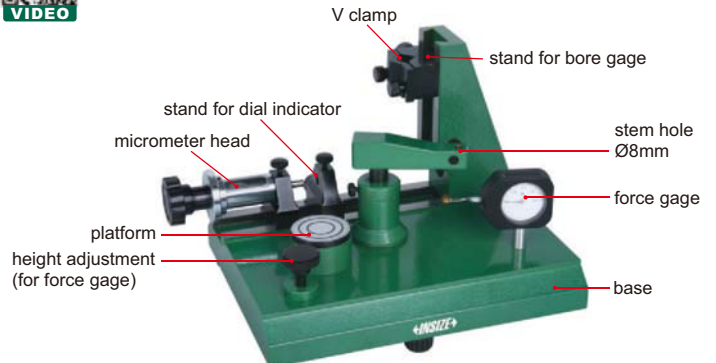

2396-25A



half round gage block code 2396-block (optional)

Half round gage block (optional)

Code	Parallelism
2396-block	1µm



Inspect accuracy of dial indicators (range 0-25mm)



Inspect accuracy of dial bore gages (range 6-450mm)



Inspect accuracy of test indicators



Test force of dial indicators



Test repeatability of dial indicators



Test the effect of lateral force on accuracy of dial indicators (half round gage block is required)



Test the effect of lateral force on accuracy of test indicators (half round gage block is required)

MAGNETIC STANDS

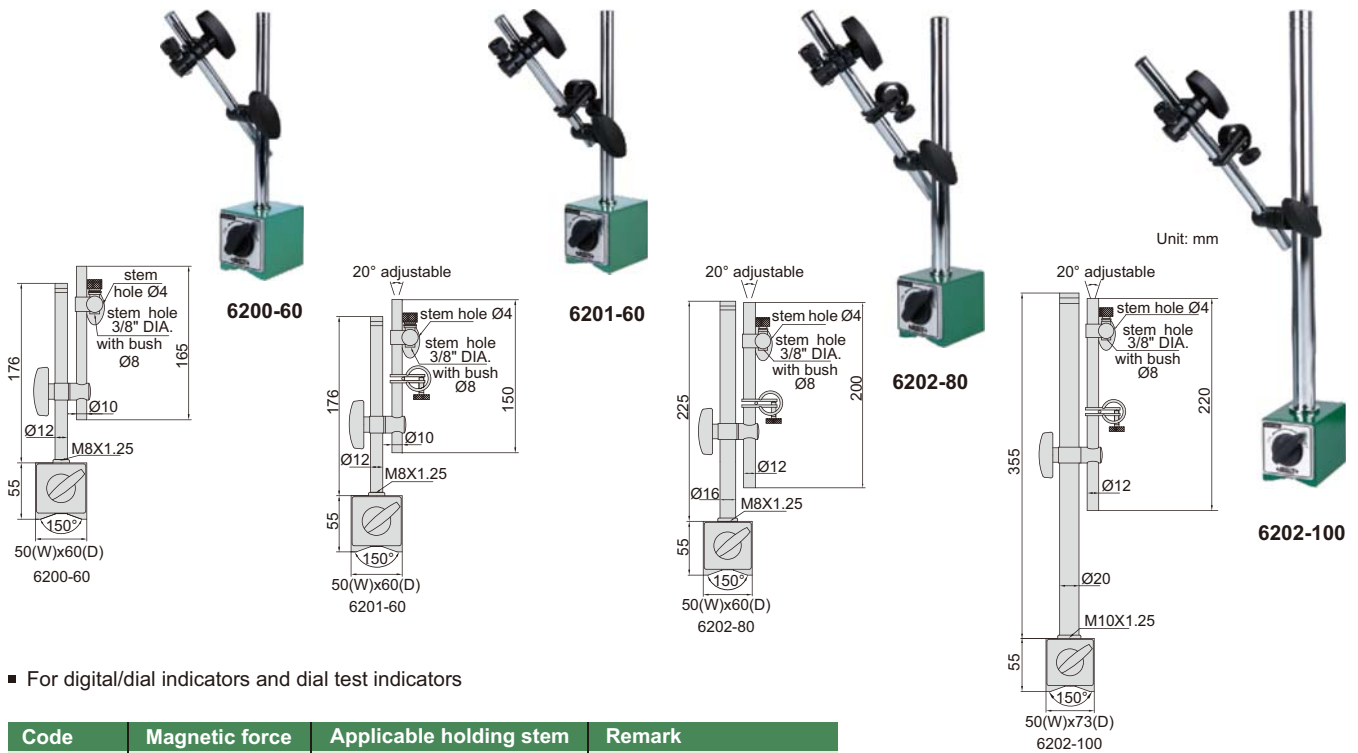

■ For digital/dial indicators and dial test indicators

Code	Magnetic force	Applicable holding stem	Remark
6200-60	60kgf	Ø8mm, Ø4mm, 3/8" DIA.	without fine adjustment
6201-60	60kgf	Ø8mm, Ø4mm, 3/8" DIA.	with fine adjustment
6202-80	80kgf	Ø8mm, Ø4mm, 3/8" DIA.	with fine adjustment
6202-100	100kgf	Ø8mm, Ø4mm, 3/8" DIA.	with fine adjustment

UNIVERSAL MAGNETIC STANDS (HEAVY DUTY)

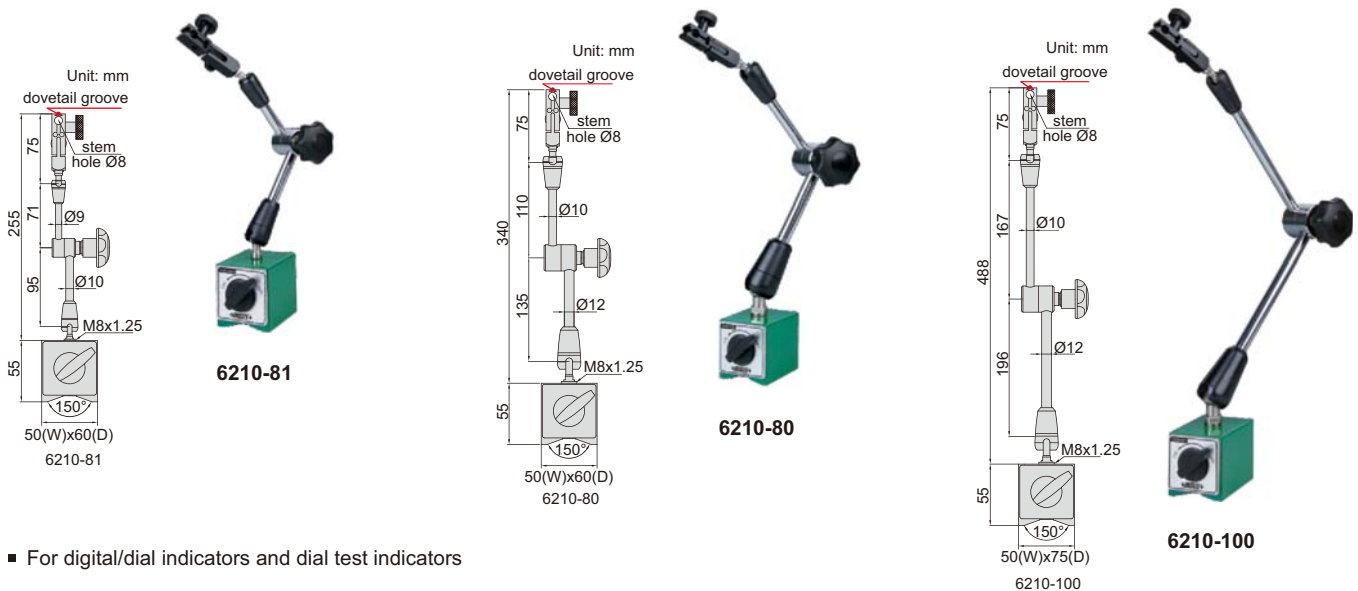

■ For digital/dial indicators and dial test indicators

Code	Magnetic force	Applicable holding stem	Remark
6210-81	80kgf	Ø8mm	with fine adjustment and dovetail groove
6210-80	80kgf	Ø8mm	with fine adjustment and dovetail groove
6210-100	100kgf	Ø8mm	with fine adjustment and dovetail groove

UNIVERSAL MAGNETIC STAND (LIGHT DUTY)

ATTENTION: LOW LOCKING FORCE

- For digital/dial indicators and dial test indicators

Code	Magnetic force	Applicable holding stem	Remark
6208-80A	80kgf	Ø8mm	with fine adjustment and dovetail groove



6208-80A

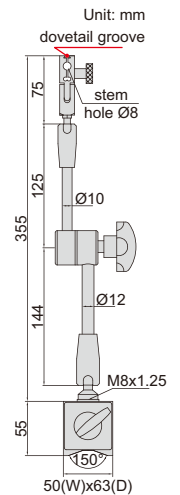

MAGNETIC STAND WITH DOUBLE FINE ADJUSTMENT

- With double fine adjustments on the head and on the base
- For digital/dial indicators and dial test indicators

Code	Magnetic force	Applicable holding stem	Remark
6272-80	80kgf	Ø8mm	with double fine adjustment and dovetail groove

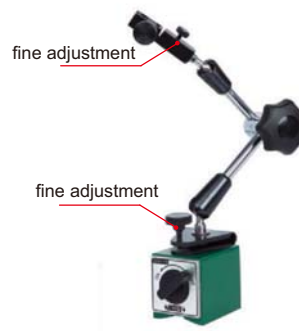

6272-80

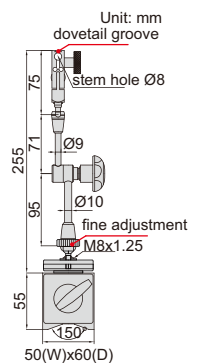

MAGNETIC STAND FOR UNEVEN SURFACE

- For digital/dial indicators and dial test indicators
- With fine adjustment

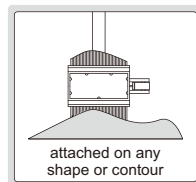

Code	Magnetic force	Applicable holding stem
6215-60	60kgf	Ø8mm, Ø4mm, 3/8" DIA.



6215-60

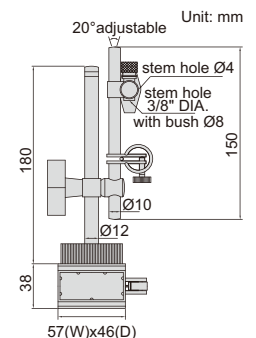

VACUUM STAND

- For granite surface plates or cast iron surface plates
- For digital/dial indicators and dial test indicators

Code	Diameter of vacuum disc	Vacuum force	Applicable holding stem	Remark
6217-B	Ø80mm	80kgf	Ø8mm	with fine adjustment and dovetail groove



6217-B

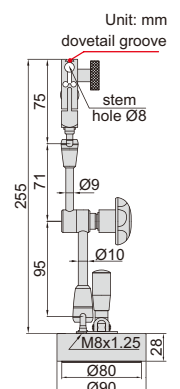

UNIVERSAL STAND

- For digital/dial indicators and dial test indicators
- With fine adjustment

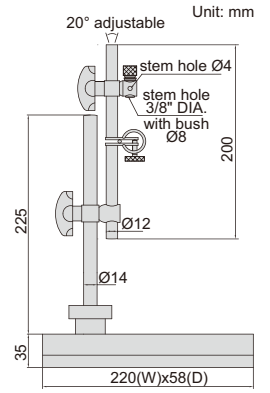

Code	Applicable holding stem
6214-A	Ø8mm, Ø4mm, 3/8" DIA.

FLEX ARM MAGNETIC STAND

ATTENTION: FOR DIAL TEST INDICATORS ONLY

- For dial test indicators

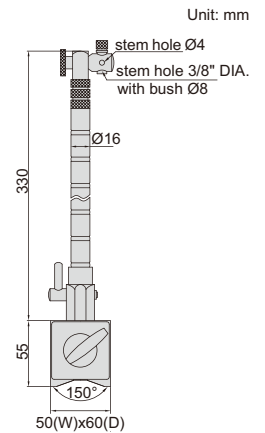

Code	Magnetic force	Applicable holding stem
6207-80A	80kgf	Ø8mm, Ø4mm, 3/8" DIA.

MINI MAGNETIC STAND

ATTENTION: FOR DIAL TEST INDICATORS ONLY

- For dial test indicators
- With fine adjustment and dovetail groove

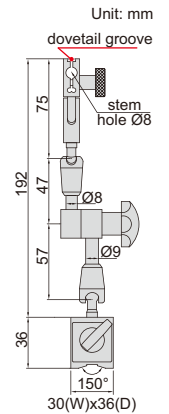

Code	Magnetic force	Applicable holding stem
6224-40	40kgf	Ø8mm

MINI MAGNETIC STAND

ATTENTION: FOR DIAL TEST INDICATORS ONLY

- For dial test indicators
- With dovetail groove

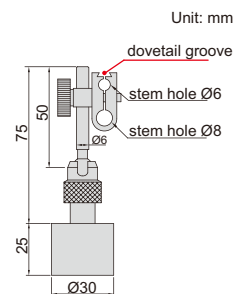

Code	Magnetic force	Applicable holding stem
6211-10	10kgf	Ø6mm, Ø8mm

GRANITE DIAL INDICATOR STAND

- Vertical travel of holder: 150mm
- Fine adjustment range: 2mm
- Supplied with dust cover

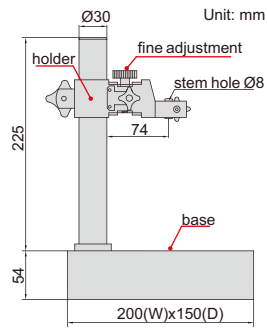

dust cover (included)



6866-150

Code	Applicable holding stem	Base
6866-150	Ø8mm	flatness 2.5µm

GRANITE DIAL INDICATOR STAND

dust cover (included)



- Vertical travel of holder: 250mm
- Fine adjustment range: entire stroke
- Supplied with dust cover

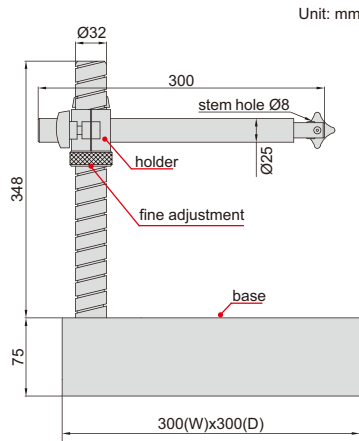

6867-250

Code	Applicable holding stem	Base
6867-250	Ø8mm	flatness 2.8µm

DIAL INDICATOR STAND

- Vertical travel of holder: 150mm
- Fine adjustment range: 2mm
- Supplied with dust cover

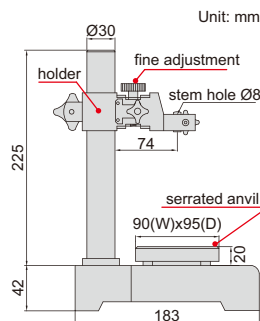

dust cover (included)



6863-150

Code	Applicable holding stem	Anvil
6863-150	Ø8mm	serrated, flatness 1.5µm, hardness HRC60±2

DIAL INDICATOR STAND

- Vertical travel of holder: 250mm
- Fine adjustment range: entire stroke
- Supplied with dust cover

dust cover (included)

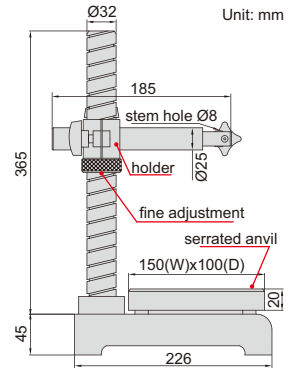

Code	Applicable holding stem	Anvil
6864-250	Ø8mm	serrated, flatness 1.5µm, hardness HRC60±2

DIAL INDICATOR STANDS

dust cover (included)



- Vertical travel of holder: 100mm
- Fine adjustment range: 2mm
- Supplied with dust cover



6862-1001



6862-1002

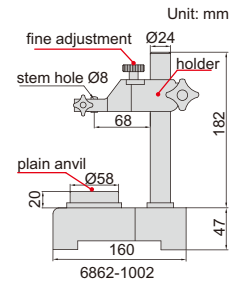
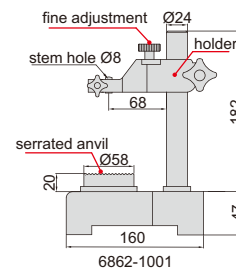

Code	Applicable holding stem	Anvil
6862-1001	Ø8mm	serrated, flatness 1.5µm, hardness HRC60±2
6862-1002	Ø8mm	plain, flatness 1.5µm, hardness HRC60±2

TRANSFER STAND

dust cover (included)



- Vertical travel of holder: 335mm
- Fine adjustment range: 2mm
- Supplied with dust cover



Application



Rigid construction, designed to make comparison height measurement (set zero with gage block then measure height of workpiece) with dial indicators or digital indicators (variation of measuring force is high)

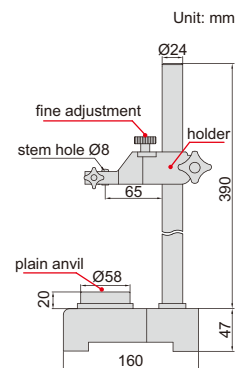

Code	Applicable holding stem	Anvil
6865-300	Ø8mm	plain, flatness 1.5µm, hardness HRC60±2

CONCENTRICITY GAGES

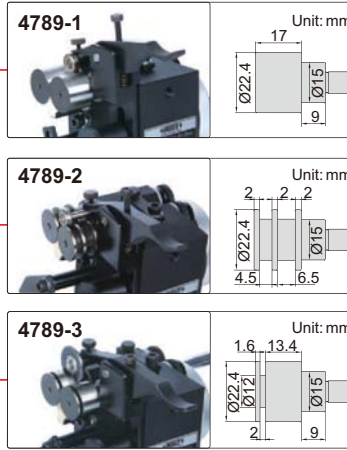

- Accuracy 2µm
- Optional accessory: dial test indicator, mini magnetic stand (code 6224-40)

Code	Applicable diameter
4789-1	Ø3.5mm-25mm
4789-2	Ø1mm-25mm
4789-3	Ø1mm-25mm

recommended outstretch length ≤ 30mm

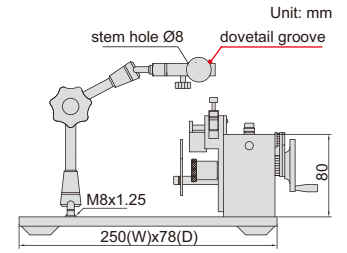
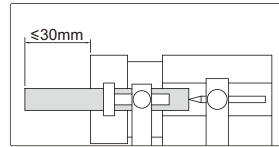

CONCENTRICITY GAGE

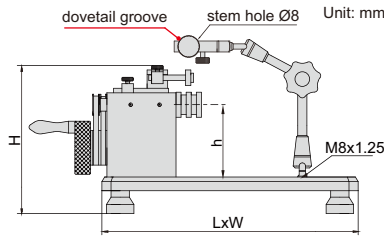

recommended outstretch length ≤ 30mm

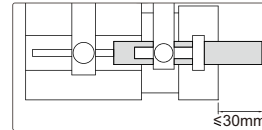

HIGH STABILITY, LONG WORKING LIFE

dial test indicator is not included



- With ball bearing, high stability, long working life

Code	Accuracy	Diameter range	Center height (h)	LxHxW	Weight
4725-45	2µm	3-45mm	80mm	280x130x150mm	6kg
4725-60	2µm	5-60mm	90mm	428x215x200mm	16.5kg
4725-80	2µm	8-80mm	130mm	445x256x260mm	29.5kg

CONCENTRICITY GAGES

QUICK-POSITIONING, SUITABLE FOR MASS MEASUREMENT

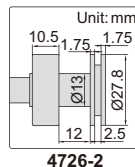
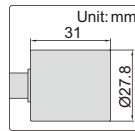
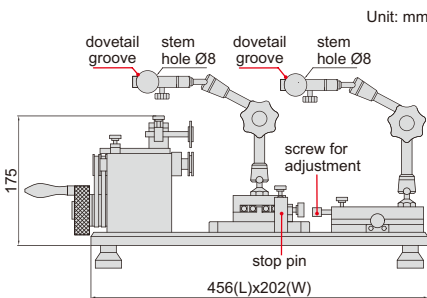

recommended outstretch length ≤ 30mm

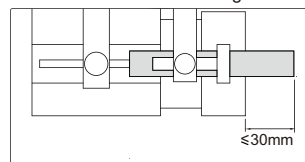

dial test indicator is not included

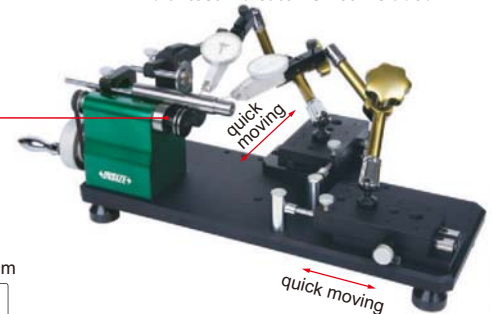

- With ball bearing, high stability, long working life
- Accuracy: 2µm
- Optional accessory: dial test indicator

Code	Applicable diameter
4726-1	Ø3-40mm
4726-2	Ø1-40mm

4726-2

CONCENTRICITY GAGE

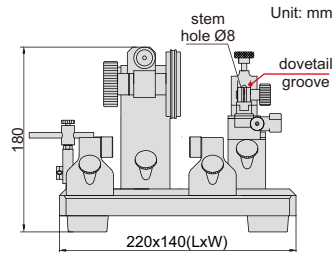

VIDEO

dial test indicator is not included



4724-25

Code	Accuracy	Diameter range	Workpiece length		Load
			Without optional stand	With optional stand	
4724-25	3µm	3-25mm	0-220mm	0-120mm	5kg

Application

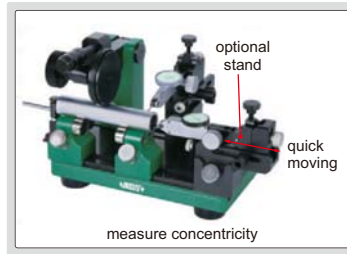

Stand (optional)

Code
4724-STAND



4724-STAND

MINI BENCH CENTER

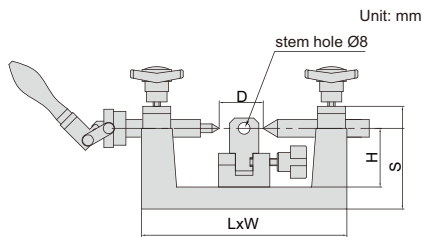

VIDEO

4721-75A

Code	Runout accuracy	Center height (H)	Distance between two centers (D)	Taper of center	Size (LxWxS)	Weight	Load
4721-75A	2µm	40mm	35-100mm	MT1	175x119x70mm	4.5kg	4kg

VERTICAL AND HORIZONTAL BENCH CENTER



VIDEO



horizontal use

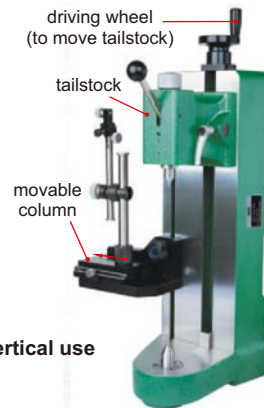

vertical use

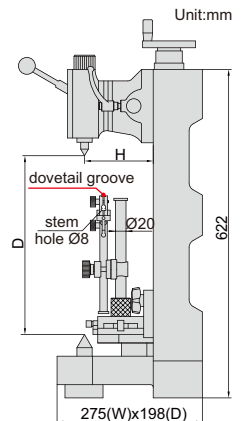

- For vertical and horizontal use
- Move tailstock by driving wheel

Code	Parallelism*	Runout accuracy	Center height (H)	Distance between two centers (D)	Taper of upper center	Taper of lower center	Weight	Load
4783-380	0.01mm	2µm	130mm	380mm	MT2	MT3	80kg	60kg

* Parallelism of two centers to the guide surface

VERTICAL AND HORIZONTAL BENCH CENTER

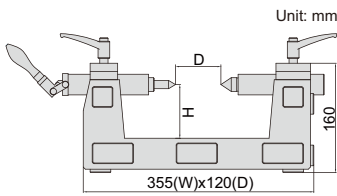

horizontal use



side use



vertical use

- For vertical, side and horizontal use

Code	Runout accuracy	Center height (H)	Distance between two centers (D)	Taper of center	Weight	Load
4722-200	2µm	80mm	200mm	MT1/MT3	22kg	25kg

BENCH CENTER WITH STRAIGHTNESS MEASUREMENT

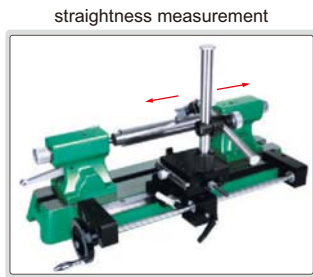

straightness measurement

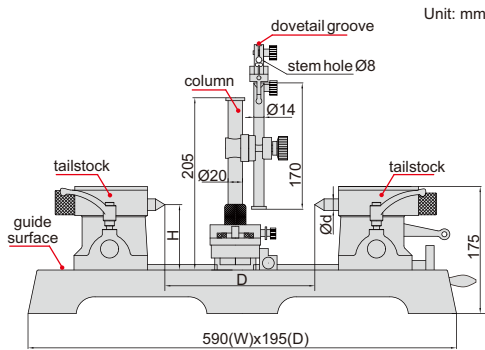

Unit: mm



4723-300

- Hardened cast-iron guide surface

Code	Parallelism *	Runout accuracy	Accuracy of straightness measurement	Center height (H)	Distance between two centers (D)	Diameter of center (Ød)	Taper of center	Weight	Load
4723-300	4µm	2µm	0.01mm	90mm	300mm	18mm	MT2	38kg	25kg

* Parallelism of two centers to the guide surface

BENCH CENTER WITH ROLLER TAILSTOCKS

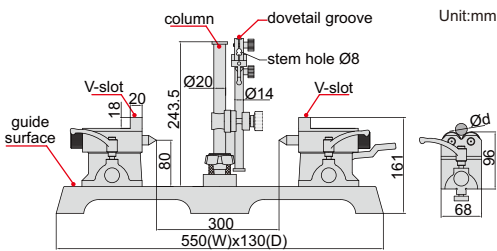

Unit: mm

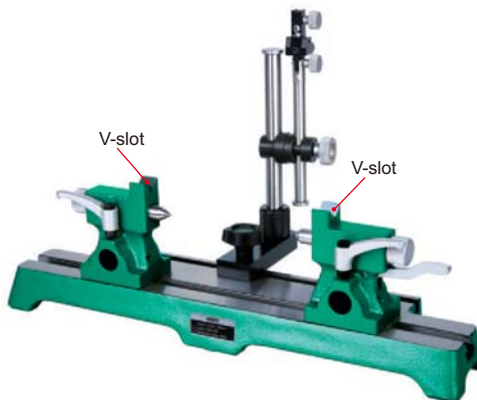

4720-300

roller tailstocks (included)



- Hardened cast-iron guide surface
- Supplied with V-slot/center tailstocks and roller tailstocks
- V-slot for cylinder Ø4~22mm
- Roller for cylinder Ø5~100mm

Code	Parallelism *	Runout accuracy	Center height	Distance between two centers	Taper of center	Load
4720-300	0.01mm	2µm	80mm	300mm	MT1	25kg (40kg for roller tailstocks)

* Parallelism of two centers to the guide surface

BENCH CENTER (BASIC MODEL)

- Hardened cast-iron guide surface
- Movable column
- V-slot for cylinder Ø4~Ø22mm

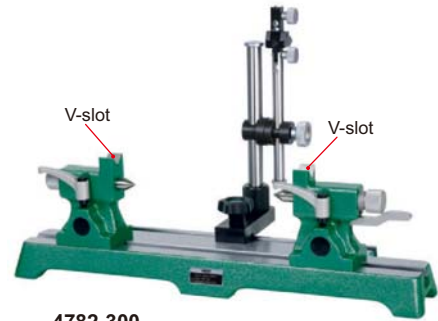
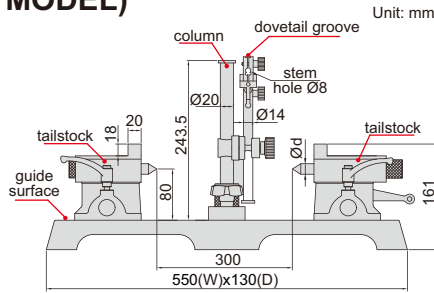

4782-300

Code	Parallelism*	Runout accuracy	Center height	Distance between two centers	Diameter of center (Ød)	Load
4782-300	0.01mm	2µm	80mm	300mm	Ø16mm	25kg

* Parallelism of two centers to the guide surface

BENCH CENTERS

- Movable column

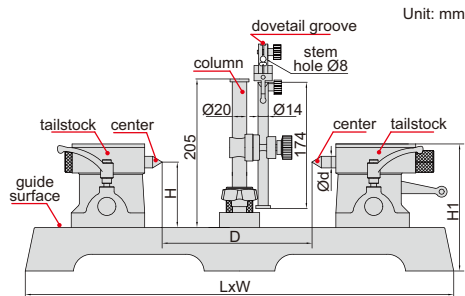

4788-300



High accuracy (heavy weight, hardened guide surface)

Code	Parallelism*	Runout accuracy	Center height (H)	Distance between two centers(D)	LxW	Height (H1)	Diameter of center (Ød)	Taper of center	Weight	Load
4788-300	0.010mm	2µm	90	300	590x192	175	18.0	MT2	34kg	25kg
4788-400	0.010mm	2µm	130	400	770x206	241	24.1	MT3	66kg	60kg
4788-600	0.010mm	2µm	130	600	930x220	250	24.1	MT3	90kg	60kg
4788-600H2	0.010mm	2µm	200	600	930x220	325	24.1	MT3	105kg	60kg
4788-1000	0.010mm	3µm	130	1000	1330x220	262	24.1	MT3	112kg	60kg
4788-1000H2	0.010mm	3µm	200	1000	1330x220	337	24.1	MT3	125kg	85kg
4788-1000H3	0.010mm	3µm	300	1000	1330x220	442	31.6	MT4	165kg	85kg

* Parallelism of two centers to the guide surface

Low accuracy (light weight, guide surface is not hardened)

Code	Parallelism*	Runout accuracy	Center height (H)	Distance between two centers(D)	LxW	Height (H1)	Diameter of center (Ød)	Taper of center	Weight	Load
4788-D2	0.010mm	3µm	90	200	490x180	175	18.0	MT2	27kg	25kg
4788-D3	0.010mm	3µm	90	300	590x195	175	18.0	MT2	36kg	25kg
4788-D4	0.012mm	3µm	130	400	730x205	241	24.1	MT3	68kg	60kg
4788-D6	0.015mm	3µm	130	600	930x220	250	24.1	MT3	91kg	60kg
4788-D8	0.015mm	3µm	130	800	1130x220	250	24.1	MT3	99kg	60kg
4788-D10	0.015mm	3µm	130	1000	1330x220	262	24.1	MT3	116kg	60kg

* Parallelism of two centers to the guide surface

SINE BENCH CENTER



4157-200

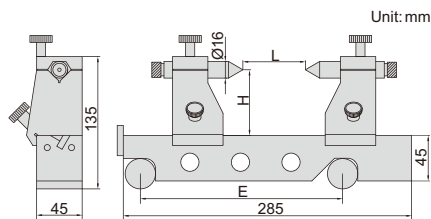

- Check taper or runout of taper bars
- Sine bar accuracy ($\alpha=30^\circ$): ± 5 seconds

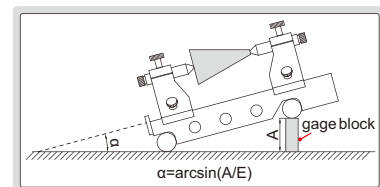

Code	Accuracy	Center height (H)	Center distance (L)
4157-200	0.01mm	65mm	200mm

INTERNAL DIAL CALIPER GAGES

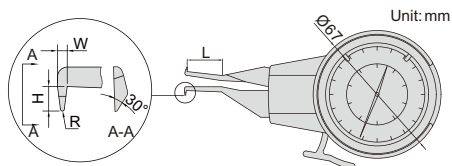

2222-15

Code	Range	Graduation	Accuracy	L	H	W	R
2222-15	5-15mm	0.01mm	±0.03mm	20	2	2.5	R0.3
2222-25	5-25mm	0.01mm	±0.03mm	35	1.5	1.0	R0.3
2222-301	10-30mm	0.01mm	±0.03mm	55	5.5	2.5	R0.5
2222-401	20-40mm	0.01mm	±0.03mm	80	6.0	3.0	R0.5
2222-501	30-50mm	0.01mm	±0.03mm	80	8.0	3.0	R0.5
2222-60	40-60mm	0.01mm	±0.03mm	80	8.0	3.0	R0.5

INTERNAL DIAL CALIPER GAGES

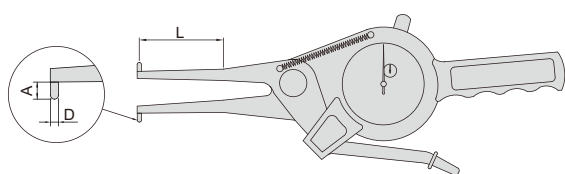

2321-35

Code	Range	Graduation	Accuracy	L	A	D
2321-35	15-35mm	0.01mm	±0.04mm	50	3	Ø3
2321-AL35	15-35mm	0.01mm	±0.04mm	200	3	Ø3
2321-55	35-55mm	0.01mm	±0.04mm	80	6	Ø3
2321-AL55	35-55mm	0.01mm	±0.04mm	250	8	Ø3
2321-75	55-75mm	0.01mm	±0.04mm	90	8	Ø3
2321-AL75	55-75mm	0.01mm	±0.04mm	250	8	Ø3
2321-95	75-95mm	0.01mm	±0.04mm	100	8	Ø3
2321-115	95-115mm	0.01mm	±0.04mm	120	10	Ø3.2
2321-135	115-135mm	0.01mm	±0.04mm	120	10	Ø3.2

■ Carbide measuring tips

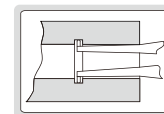

DATA OUTPUT



- Carbide measuring tips
- Reading in digit and analog
- Display can be rotated by 320°
- Button function: tolerance Go and No-Go display, data preset, measuring direction change, max./min./TIR measurement, inch/metric conversion, absolute/incremental measurement
- CR2032 battery, automatic power off
- Data output
- Optional accessory: data output cable (code 7306-40, 7302-SPC3A, 7305-SPC1A)

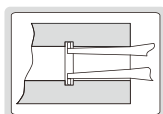

DIGITAL INTERNAL CALIPER GAGES



2151-35

Code	Range	Resolution	Accuracy	L	A	D
2151-35	15-35mm/0.6-1.4"	0.01mm/0.0005"	±0.04mm	50	3	Ø3
2151-AL35	15-35mm/0.6-1.4"	0.01mm/0.0005"	±0.04mm	200	3	Ø3
2151-55	35-55mm/1.4-2.2"	0.01mm/0.0005"	±0.04mm	80	6	Ø3
2151-AL55	35-55mm/1.4-2.2"	0.01mm/0.0005"	±0.04mm	250	8	Ø3
2151-75	55-75mm/2.2-3"	0.01mm/0.0005"	±0.04mm	90	8	Ø3
2151-AL75	55-75mm/2.2-3"	0.01mm/0.0005"	±0.04mm	250	8	Ø3
2151-95	75-95mm/3-3.8"	0.01mm/0.0005"	±0.04mm	100	8	Ø3
2151-115	95-115mm/3.8-4.6"	0.01mm/0.0005"	±0.04mm	120	10	Ø3.2
2151-135	115-135mm/4.6-5.4"	0.01mm/0.0005"	±0.04mm	120	10	Ø3.2

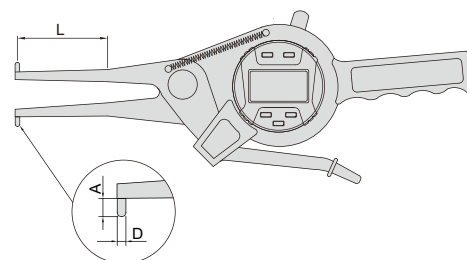

EXTERNAL DIAL CALIPER GAGES



2333-201

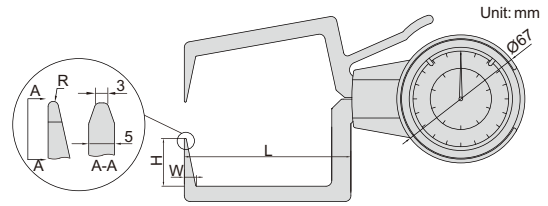

Code	Range	Graduation	Accuracy	L	H	W	R
2333-201	0-20mm	0.01mm	±0.03mm	80	25	6.5	R0.5
2333-301	10-30mm	0.01mm	±0.03mm	80	25	6.5	R0.5
2333-401	20-40mm	0.01mm	±0.03mm	80	25	6.5	R0.5
2333-501	30-50mm	0.01mm	±0.03mm	80	25	6.5	R0.5
2333-601	40-60mm	0.01mm	±0.03mm	80	25	6.5	R0.5

EXTERNAL DIAL CALIPER GAGES



2332-20

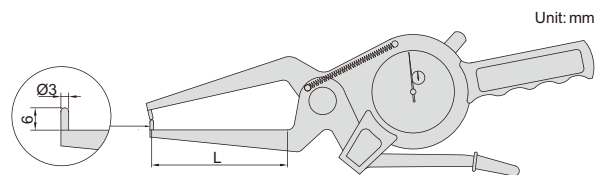

Code	Range	Graduation	Accuracy	L (mm)
2332-20	0-20mm	0.01mm	±0.04mm	60
2332-40	20-40mm	0.01mm	±0.04mm	60
2332-60	40-60mm	0.01mm	±0.04mm	55
2332-80	60-80mm	0.01mm	±0.04mm	55
2332-100	80-100mm	0.01mm	±0.04mm	55

- Carbide measuring tips

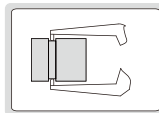

DIGITAL EXTERNAL CALIPER GAGES

DATA OUTPUT

- Carbide measuring tips
- Reading in digit and analog
- Display can be rotated by 320°
- Button function: tolerance Go and No-Go display, data preset, measuring direction change, max./min./TIR measurement, inch/metric conversion, absolute/incremental measurement
- CR2032 battery, automatic power off
- Data output
- Optional accessory: data output cable (code 7306-40, 7302-SPC3A, 7305-SPC1A)



2132-20

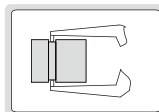

Code	Range	Resolution	Accuracy	L (mm)
2132-20	0-20mm/0-0.8"	0.01mm/0.0005"	±0.04mm	60
2132-40	20-40mm/0.8-1.6"	0.01mm/0.0005"	±0.04mm	60
2132-60	40-60mm/1.6-2.4"	0.01mm/0.0005"	±0.04mm	55
2132-80	60-80mm/2.4-3.2"	0.01mm/0.0005"	±0.04mm	55
2132-100	80-100mm/3.2-4"	0.01mm/0.0005"	±0.04mm	55

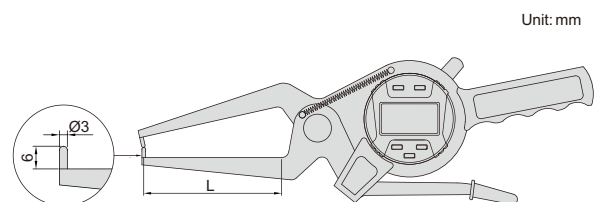

DIGITAL THICKNESS GAGES

- Ceramic spindle tip and anvil
- Buttons: on/off, zero, mm/inch
- Battery CR2032, automatic power off
- Data output
- Optional accessory: data output cable (code 7306-40, 7302-SPC3A, 7305-SPC1A)

Code	Range	Resolution	Accuracy
2871-10	0-10mm/0-0.4"	0.01mm/0.0005"	±0.02mm
2871-101	0-10mm/0-0.4"	0.001mm/0.00005"	±0.005mm

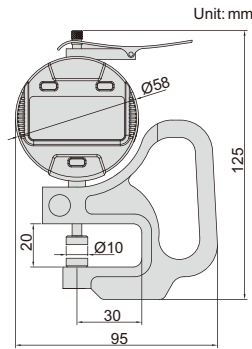

DATA
OUTPUT

2871-101

THICKNESS GAGES

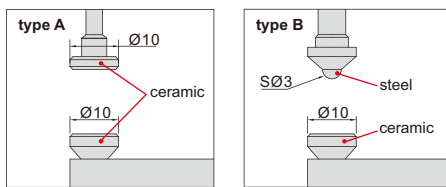

Code	Range	Graduation	Accuracy	Type
2364-10	0-10mm	0.01mm	±0.02mm	A
2364-10B	0-10mm	0.01mm	±0.02mm	B

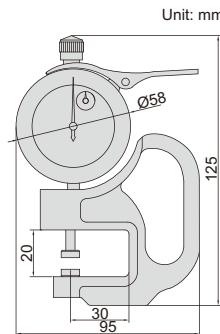

2364-10

THICKNESS GAGES

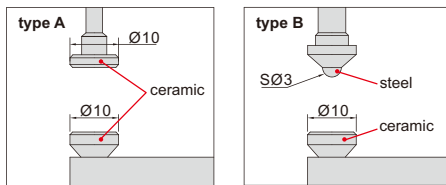

Code	Range	Graduation	Accuracy	Type
2366-30	0-30mm	0.01mm	±0.035mm	A
2366-30B	0-30mm	0.01mm	±0.035mm	B

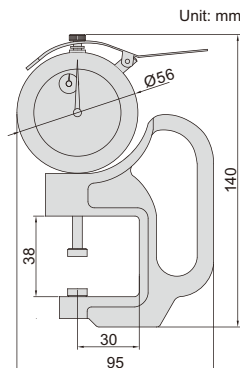

2366-30

DIGITAL THICKNESS GAGE

- Ceramic spindle tip and anvil
- Buttons: on/off, zero, mm/inch
- Battery CR2032, automatic power off
- Data output
- Optional accessory: data output cable (code 7306-40, 7302-SPC3A, 7305-SPC1A)

Code	Range	Resolution	Accuracy
2872-10	0-10mm/0-0.4"	0.01mm/0.0005"	±0.02mm

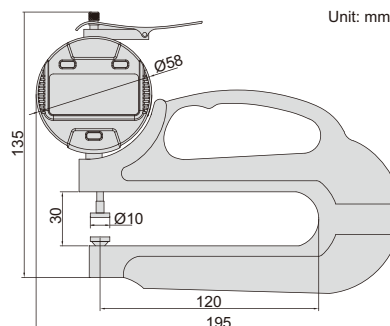

DATA
OUTPUT

2872-10

THICKNESS GAGES

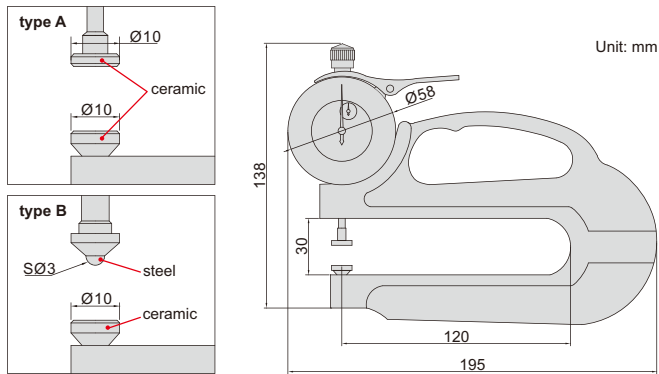

Unit: mm

Code	Range	Graduation	Accuracy	Type
2365-10	0-10mm	0.01mm	±0.02mm	A
2365-20	0-20mm	0.01mm	±0.03mm	A
2365-10B	0-10mm	0.01mm	±0.02mm	B
2365-20B	0-20mm	0.01mm	±0.03mm	B

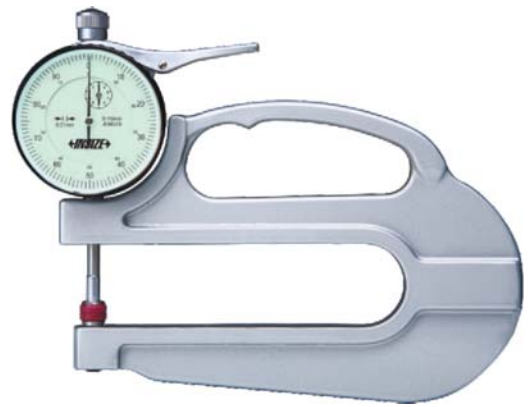

2365-10

THICKNESS GAGE

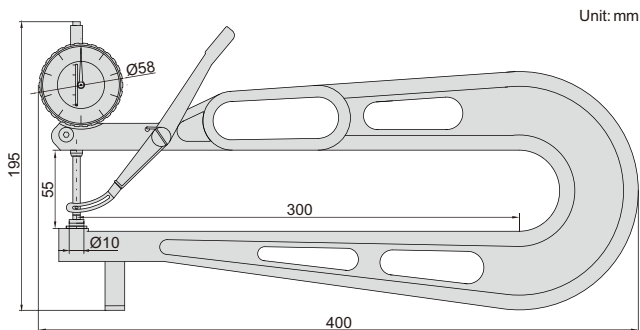

Unit: mm

Code	Range	Graduation	Accuracy
2875-30	0-30mm	0.1mm	±0.05mm



2875-30



DIGITAL TUBE THICKNESS GAGE

Measure wall thickness of groove

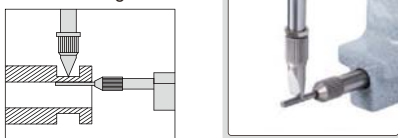

- Buttons: on/off, zero, mm/inch
- Battery CR2032, automatic power off
- Data output
- Optional accessory: data output cable (code 7306-40, 7302-SPC3A, 7305-SPC1A)

Code	Range	Resolution	Accuracy
2873-10	0-10mm/0-0.4"	0.01mm/0.0005"	±0.02mm



2873-10

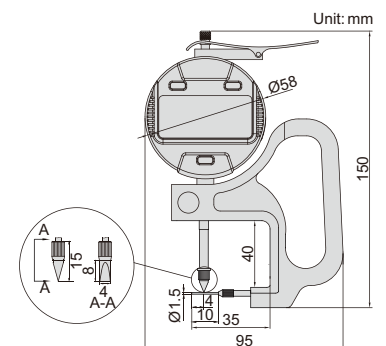

DATA OUTPUT

Unit: mm

DATA
OUTPUT

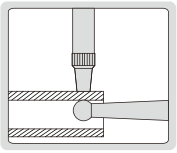

- Buttons: on/off, zero, mm/inch
- Battery CR2032, automatic power off
- Data output
- Optional accessory: data output cable (code 7306-40, 7302-SPC3A, 7305-SPC1A)

Code	Range	Resolution	Accuracy
2876-10	0-10mm/0-0.4"	0.01mm/0.0005"	±0.02mm

DIGITAL TUBE THICKNESS GAGE



2876-10

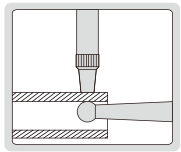
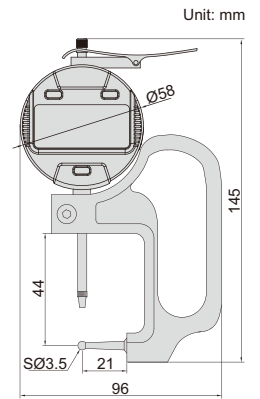

- Measure tube wall thickness

Code	Range	Graduation	Accuracy
2367-10A	0-10mm	0.01mm	±0.02mm

TUBE THICKNESS GAGE



2367-10A

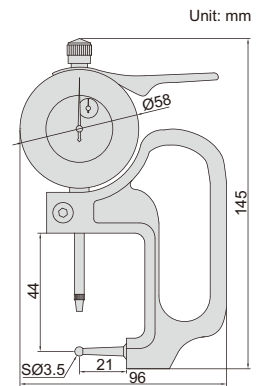

SUITABLE FOR
JEWELLERY

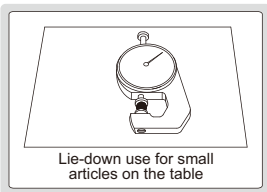

Code	Range	Graduation	Accuracy
2361-10	0-10mm	0.1mm	±0.05mm

THICKNESS GAGE



2361-10

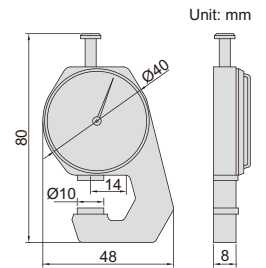

- Stainless steel spindle tip and anvil

Code	Range	Graduation	Accuracy
2363-10	0-10mm	0.01mm	±0.03mm



2363-10

THICKNESS GAGE

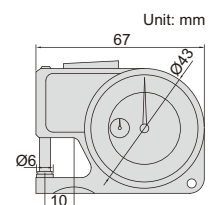

THICKNESS GAGES

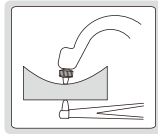

Code	Range	Graduation	Accuracy	L	L1
2862-101	0-10mm	0.05mm	±0.1mm	35	85
2862-102	0-10mm	0.05mm	±0.1mm	60	110



2862-101

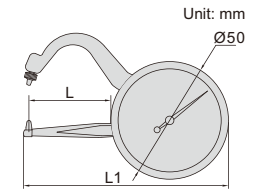

THICKNESS GAGE

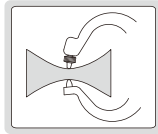

Code	Range	Graduation	Accuracy
2863-10	0-10mm	0.05mm	±0.1mm



2863-10

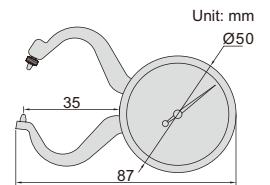

THICKNESS GAGE WITH POINTED TIPS

- Pointed tips fit into small grooves and recesses

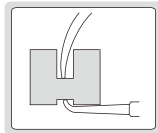

Code	Range	Graduation	Accuracy
2866-10	0-10mm	0.05mm	±0.1mm



2866-10

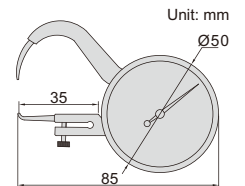

DIAL SNAP GAGES



- For quick Go/No-Go judgement
- Carbide measuring faces
- Height of support is adjustable
- Optional accessory: dial indicators (graduation 0.001mm) and digital indicators (resolution 0.001mm)

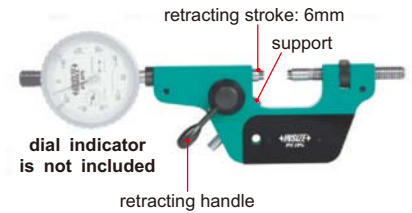
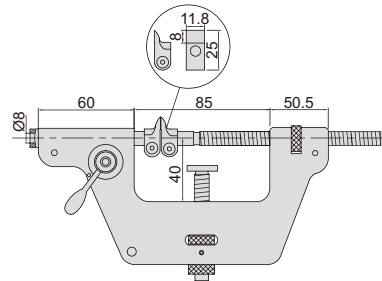
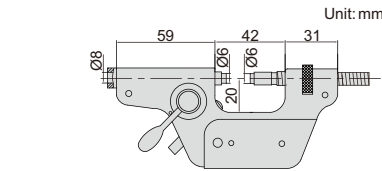

3337-40

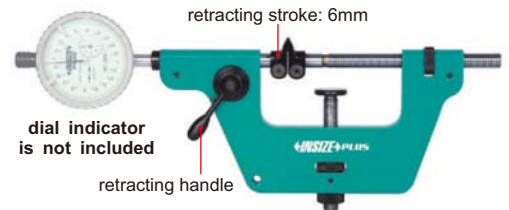

3337-60

Code	Range	Parallelism of measuring faces	Retracting stroke	Remark
3337-40	0-40mm	1µm	6mm	
3337-60	0-60mm	3µm	6mm	jaw type measuring tips

Stand (optional)

Code
3337-STAND

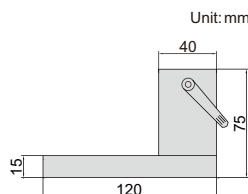

3337-STAND

DIAL SNAP GAGES

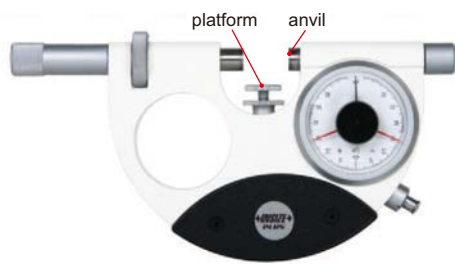

3335-25

(mm)

Code	Range	L	a	b
3335-25	0-25mm	35	191	<15
3335-50	25-50mm	60	215	<25
3335-75	50-75mm	84	239	<37.5
3335-100	75-100mm	110	265	<50

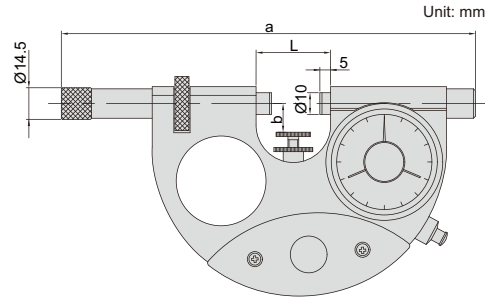

IP54 WATERPROOF

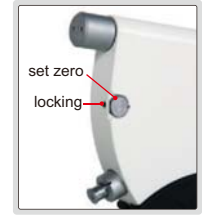

- Quick Go/No-Go measurement for mass production
- Anvil retracting stroke: 2.5mm
- Dial indicator: measuring range $\pm 0.07\text{mm}$, graduation $1\mu\text{m}$, accuracy $1\mu\text{m}$
- Constant measuring force over the whole range: 8.5N
- Carbide measuring faces
- IP54 dust/waterproof
- Zero position of dial indicator is adjustable and can be locked (supplied with locking wrench)
- Adjustable platform height

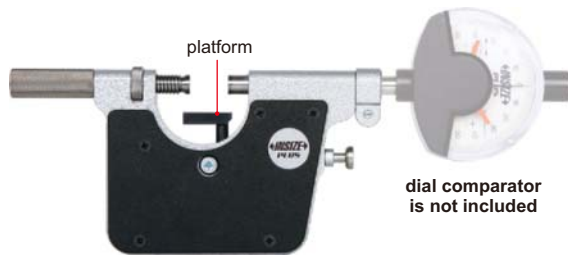

3336-25

dial comparator is not included

Code	Range	Diameter of measuring faces ($\varnothing d$)
3336-25	0-25mm	8mm
3336-50	25-50mm	8mm
3336-100	50-100mm	15mm

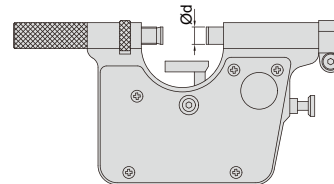

DIAL SNAP GAGES



- Quick Go/No-Go judgement for mass production
- Carbide measuring faces
- Adjustable platform height
- Optional accessory: dial comparator (code 2881-01)

DIAL SNAP GAGES

- For quick Go/No-Go judgment of diameter of cylinders and shafts
- Left anvil retracting stroke: 2mm
- Measuring force: 6-8N
- Flatness of anvil: $1.5\mu\text{m}$
- Repeatability: $1\mu\text{m}$
- Carbide measuring faces for anvils
- Front edges of anvils are chamfered for easy workpiece insertion
- Optional accessory: dial indicators and digital indicators (reading 0.001mm or 0.01mm)



dial indicator is not included

2186-25

(mm)

Code	Range	Parallelism of measuring faces	A	B	C
2186-25	0-25mm	$4\mu\text{m}$	42	11-18	20
2186-50	25-50mm	$4\mu\text{m}$	69	11-32	41
2186-75	50-75mm	$5\mu\text{m}$	94	17-41	51
2186-100	75-100mm	$6\mu\text{m}$	119	31-55	65
2186-125	100-125mm	$6\mu\text{m}$	144	42-70	75
2186-150	125-150mm	$8\mu\text{m}$	169	55-82	90
2186-175	150-175mm	$8\mu\text{m}$	194	68-95	100
2186-200	175-200mm	$10\mu\text{m}$	219	85-110	115
2186-225	200-225mm	$10\mu\text{m}$	244	95-120	130
2186-250	225-250mm	$10\mu\text{m}$	269	110-135	145
2186-275	250-275mm	$12\mu\text{m}$	294	120-150	160
2186-300	275-300mm	$12\mu\text{m}$	319	128-160	170

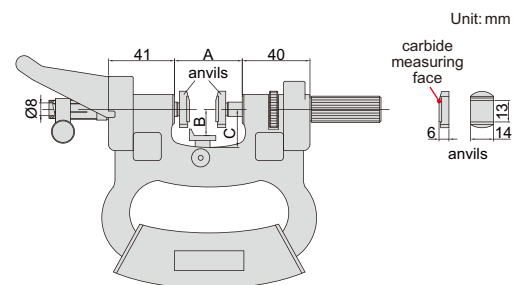

Unit: mm
carbide measuring face
6 13 14
anvils

ADJUSTABLE SNAP GAGES

- Used as Go/No-Go gage by setting upper and lower limits
- Flatness of anvil: 1.5µm
- Parallelism of measuring faces:
 - range 0-32mm: 3µm
 - range 32-89mm: 4µm
 - range 89-300mm: 5µm



2187-6

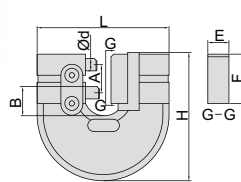

0-6mm



2187-19

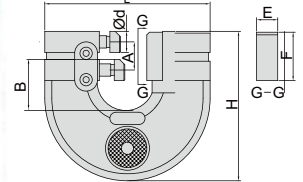

over 6mm

Code	Range	L	A	B	E	F	H	Ød
2187-6	0-6mm	74	15	17.5	12.2	27.2	71.5	7
2187-13	6-13mm	85	15	26	12.2	27.2	79.5	12.3
2187-19	13-19mm	93	15	27	12.2	27.2	83	12.3
2187-25	19-25mm	100	15	33.5	12.2	27.2	89.5	12.3
2187-32	25-32mm	111	18	38.5	15.2	35.2	104	15.3
2187-38	32-38mm	117	18	41.5	15.2	35.2	105	15.3
2187-44	38-44mm	123	18	44.5	15.2	35.2	109	15.3
2187-51	44-51mm	130	18	48	15.2	35.2	117	15.3
2187-57	51-57mm	136	18	45	15.2	35.2	119	15.3
2187-63	57-63mm	143	18	50	15.2	35.2	122	15.3
2187-70	63-70mm	156	20	58	15.2	35.2	132	15.3
2187-76	70-76mm	163	20	60.5	15.2	35.2	137	15.3
2187-82	76-82mm	169	20	64.5	15.2	35.2	140	15.3
2187-89	82-89mm	175	20	66.5	15.2	35.2	146	15.3
2187-95	89-95mm	181	20	69.5	15.2	35.2	149	15.3
2187-101	95-101mm	188	20	70	15.2	35.2	154	15.3
2187-108	101-108mm	198	24	79	15.2	39.2	166	15.3
2187-114	108-114mm	204	24	81	15.2	39.2	172	15.3

(mm)

Code	Range	L	A	B	E	F	H	Ød
2187-120	114-120mm	210	24	86	15.2	39.2	179	15.3
2187-127	120-127mm	217	24	89.5	15.2	39.2	186	15.3
2187-133	127-133mm	223	24	92.5	15.2	39.2	192	15.3
2187-139	133-139mm	229	24	95.5	15.2	39.2	197	15.3
2187-146	139-146mm	235	24	98.5	15.2	39.2	201	15.3
2187-152	146-152mm	242	24	102	15.2	39.2	205	15.3
2187-163	152-163mm	273	21.4	106.7	18.2	39.2	211	18.3
2187-175	163-175mm	273	21.4	106.7	18.2	39.2	211	18.3
2187-188	175-188mm	298.5	21.4	119.7	18.2	39.2	227	18.3
2187-200	188-200mm	298.5	21.4	119.7	18.2	39.2	227	18.3
2187-213	200-213mm	324	21.4	131.7	18.2	39.2	242	18.3
2187-225	213-225mm	324	21.4	131.7	18.2	39.2	242	18.3
2187-238	225-238mm	349.5	21.4	144.7	18.2	39.2	250	18.3
2187-250	238-250mm	349.5	21.4	149	18.2	39.2	250	18.3
2187-263	250-263mm	375.5	21.4	157.7	18.2	39.2	278	18.3
2187-275	263-275mm	375.5	21.4	157.7	18.2	39.2	278	18.3
2187-288	275-288mm	400	21.4	170.7	18.2	39.2	291	18.3
2187-300	288-300mm	400	21.4	170.7	18.2	39.2	291	18.3

(mm)

DIAL SNAP GAGES



dial indicator
is not included

2184-50W

- For quick Go/No-Go judgment of diameter of cylinders and shafts
- Anvil retracting stroke: 3mm
- Measuring force: 6-9N
- Carbide measuring faces
- Optional accessory:
 - dial indicators (graduation 0.01mm),
 - digital indicators (resolution 0.01mm/0.0005")

ATTENTION: NOT SUITABLE
FOR 0.001MM INDICATORS

Code	Range	A	B
2184-25W	0-25mm	34	18
2184-50W	0-50mm	62	32
2184-100W	50-100mm	112	62
2184-150W	100-150mm	162	85
2184-200W	150-200mm	212	110

(mm)

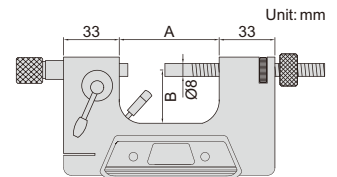

Unit: mm

DIAL SNAP GAGES



3334-25

- Go/No-Go judgement for mass production
- Dial indicator: range ±0.04mm, graduation 0.001mm, accuracy 0.001mm
- IP54 dust/waterproof
- Measuring force: 5-10N
- Carbide measuring faces
- Supplied with setting standards (except 0-25mm)

IP54
WATERPROOF

ATTENTION:
BASIC MODEL

Code	Range	L	D
3334-25	0-25mm	28.5	25
3334-50	25-50mm	53.5	35
3334-75	50-75mm	78.5	47.5
3334-100	75-100mm	103.5	60

(mm)

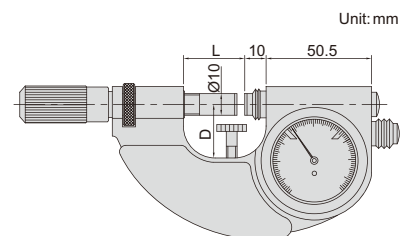

Unit: mm

DIGITAL SNAP GAGE

DATA OUTPUT

- Optional accessory: data output cable (code 7306-20, 7302-SPC1A/SPC1B, 7305-SPC2)



2166-12

Code	Range	Resolution	Accuracy
2166-12	0-12mm/0-0.5"	0.01mm/0.0005"	±0.03mm

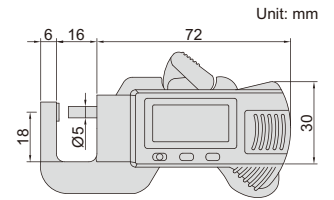

DIGITAL SNAP GAGE

ATTENTION: NO DATA OUTPUT



2167-25

Code	Range	Resolution	Accuracy
2167-25	0-25mm/0-1"	0.01mm/0.0005"	±0.03mm

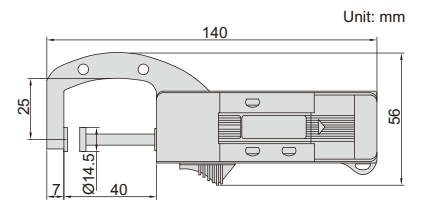

DIGITAL SNAP GAGE

DATA OUTPUT



2163-25

- Resolution: 0.01mm/0.0005"
- Accuracy: ±0.04mm
- For thickness and tube wall thickness measurement
- Optional accessory: data output cable (code 7306-20, 7302-SPC1A/SPC1B, 7305-SPC2A)

Code	Thickness range	Tube wall thickness range
2163-25	0-25mm/0-1"	0-2mm/0.08"

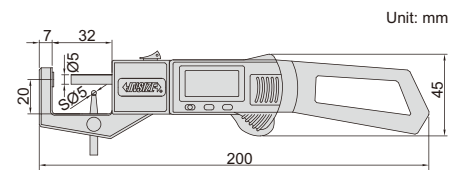
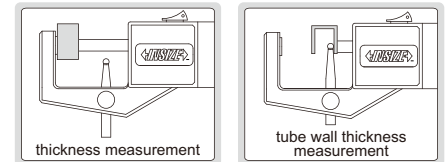

DIGITAL SNAP GAGE

DATA OUTPUT

- Buttons: on/off, zero, mm/inch
- Automatic power off, move the digital unit to turn on power
- Battery CR2032
- Data output
- Made of stainless steel
- Optional accessory: data output cable (code 7306-20, 7302-SPC5A/SPC5B, 7305-SPC2A)



1163-50A

Code	Range	Resolution	Accuracy
1163-50A	0-50mm/0-2"	0.01mm/0.0005"	±0.03mm

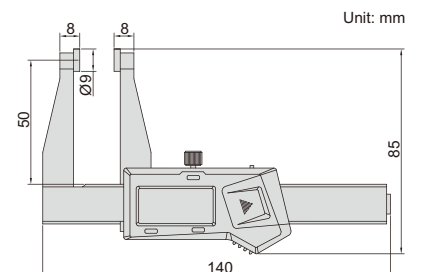

DIGITAL 3-PURPOSE SNAP GAGE



ATTENTION: NO DATA OUTPUT

SUITABLE FOR JEWELLERY

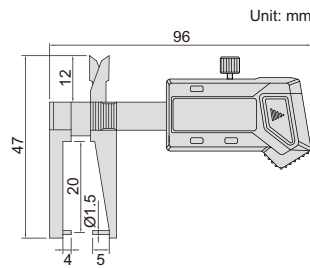
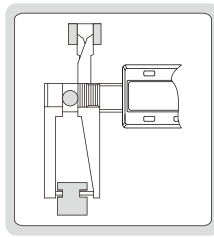

2164-25A

- Buttons: zero, mm/inch, on/off
- Battery LR44
- Made of stainless steel

Code	Range	Resolution	Accuracy
2164-25A	0-25mm/0-1"	0.01mm/0.0005"	±0.03mm

STEP AND GAP GAGE

DATA OUTPUT



zero setting block (included)



front

2168-12



back

- Measure step height and gap width
- Resolution: 0.01mm/0.0005"
- Buttons: on/off, zero, mm/inch
- Automatic power off, move the digital unit to turn on power
- Battery CR2032
- Data output
- Made of stainless steel
- Supplied with zero setting block
- Optional accessory: data output cable (code 7306-20, 7302-SPC5A/SPC5B, 7305-SPC2A)

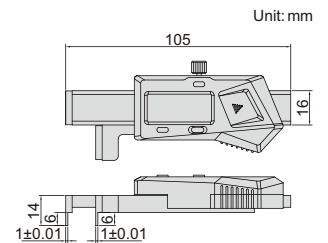
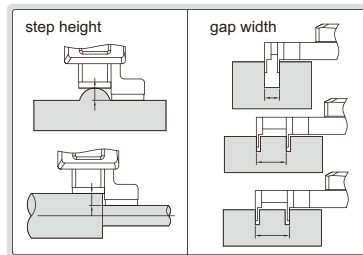

Code	Range	Accuracy
2168-12	0-12.7mm/0-0.5"	±0.03mm

CRANKSHAFT TESTERS

Unit: mm

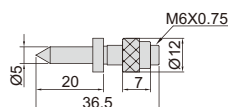
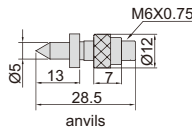
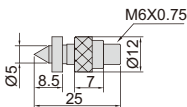
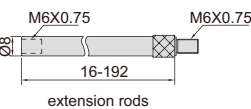
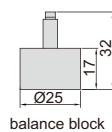
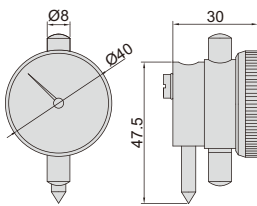

2841-500

- To test crankshaft deflection
- The balance block is mounted on the back of dial indicator to keep the dial indicator facing up

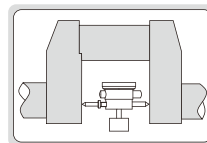

Code	Range	Dial indicator range	Graduation	Extension rods	Accuracy
2841-300	60-300mm	3mm	0.01mm	16mm, 32mm, 64mm, 128mm	±0.016mm
2841-500	60-500mm	3mm	0.01mm	16mm, 32mm, 64mm, 96mm, 128mm, 192mm	±0.016mm

SAW TEETH SETTING GAGE



front

back

2874-02

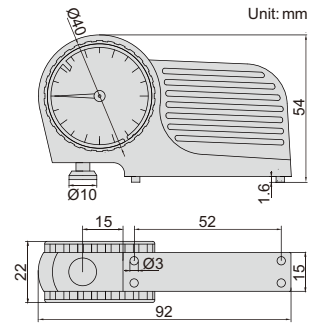

- Supplied with limit pointer
- Read from both sides

Code	Range	Graduation	Accuracy
2874-02	0-2mm	0.05mm	±0.05mm

GAGE BLOCKS

Accuracy according to ISO3650

Nominal length (mm)	Grade 0		Grade 1		Grade 2	
	Limit deviation of length	Tolerance for the variation in length	Limit deviation of length	Tolerance for the variation in length	Limit deviation of length	Tolerance for the variation in length
over 0.5 to 10	±0.12µm	0.10µm	±0.20µm	0.16µm	±0.45µm	0.30µm
over 10 to 25	±0.14µm	0.10µm	±0.30µm	0.16µm	±0.60µm	0.30µm
over 25 to 50	±0.20µm	0.10µm	±0.40µm	0.18µm	±0.80µm	0.30µm
over 50 to 75	±0.25µm	0.12µm	±0.50µm	0.18µm	±1.00µm	0.35µm
over 75 to 100	±0.30µm	0.12µm	±0.60µm	0.20µm	±1.20µm	0.35µm
over 100 to 150	±0.40µm	0.14µm	±0.80µm	0.20µm	±1.60µm	0.40µm
over 150 to 200	±0.50µm	0.16µm	±1.00µm	0.25µm	±2.00µm	0.40µm
over 200 to 250	±0.60µm	0.16µm	±1.20µm	0.25µm	±2.40µm	0.45µm
over 250 to 300	±0.70µm	0.18µm	±1.40µm	0.25µm	±2.80µm	0.50µm
over 300 to 400	±0.90µm	0.20µm	±1.80µm	0.30µm	±3.60µm	0.50µm
over 400 to 500	±1.10µm	0.25µm	±2.20µm	0.35µm	±4.40µm	0.60µm
over 500 to 600	±1.30µm	0.25µm	±2.60µm	0.40µm	±5.00µm	0.70µm
over 600 to 700	±1.50µm	0.30µm	±3.00µm	0.45µm	±6.00µm	0.70µm
over 700 to 800	±1.70µm	0.30µm	±3.40µm	0.50µm	±6.50µm	0.80µm
over 800 to 900	±1.90µm	0.35µm	±3.80µm	0.50µm	±7.50µm	0.90µm
over 900 to 1000	±2.00µm	0.40µm	±4.20µm	0.60µm	±8.00µm	1.00µm

Grade and application

Grade	Application
0	To be used as basic standards in calibration laboratories by skilled inspection staff, to calibrate or set high accuracy measuring instruments, to calibrate gage blocks of grade 1 and 2.
1	To be used in inspection rooms, to check gages, inspect high accuracy parts and set measuring instruments.
2	To be used in workshops, to check production gages, set measuring instruments and mount tools.

Inspection certificate

INSPECTION CERTIFICATE

CODE: 4130-32
GRADE: 0

GAGE BLOCKS

Nominal Size (mm)	Identification No.	Deviation (µm)	Nominal Size (mm)	Identification No.	Deviation (µm)	Nominal Size (mm)	Identification No.	Deviation (µm)
1.005	119456	+0.04	1.20	109960	+0.08	4	119118	+0.08
1.01	119496	0.00	1.30	091140	+0.03	5	114033	-0.02
1.02	101529	+0.08	1.40	112170	-0.02	6	111640	+0.07
1.03	112856	+0.08	1.5	116887	-0.02	7	119970	0.00
1.04	112140	0.00	1.6	102449	+0.05	8	119266	+0.05
1.05	106748	0.00	1.7	114888	+0.07	9	114947	+0.02
1.06	113896	-0.03	1.8	101023	+0.02	10	111703	+0.06
1.07	092953	+0.03	1.9	111542	+0.05	20	115536	+0.02
1.08	111762	0.00	1	119273	0.00	30	101817	+0.05
1.09	106008	-0.02	2	114741	+0.05	50	115454	0.00
1.10	110489	+0.07	3	116518	+0.05			

Set Serial No: 110019 Material: Steel Date: Jun 8th 2011
Standard: ISO3650 Standard reference temperature: 20°C Inspector:

CERAMIC GAGE BLOCK SETS

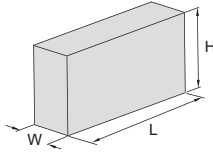

Dimension:

Size (L)	W	H
$0.5 \leq L \leq 10\text{mm}$	9mm	30mm
$L > 10\text{mm}$	9mm	35mm



4105-87

- Made of ceramic, extremely wear resistance and corrosion resistance, excellent dimension stability
- Meet ISO3650
- Supplied with manufacturer inspection certificate

Blocks per set	Gage blocks included in set			Code	
	Size (mm)	Step (mm)	Quantity	Grade 0	Grade 1
112	1.0005		1	4105-112	4105-1112
	1.001-1.009	0.001	9		
	1.01-1.49	0.01	49		
	0.5-24.5	0.5	49		
103	25-100	25	4	4105-103	4105-1103
	1.005		1		
	1.01-1.49	0.01	49		
	0.5-24.5	0.5	49		
88	25-100	25	4	4105-88	4105-188
	1.0005		1		
	1.001-1.009	0.001	9		
	1.01-1.49	0.01	49		
87	0.5-9.5	0.5	19	4105-87	4105-187
	10-100	10	10		
	1.001-1.009	0.001	9		
	1.01-1.49	0.01	49		
76	0.5-9.5	0.5	19	4105-76	4105-176
	10-40	10	4		
	50-100	25	3		
	1.005		1		
56	1.01-1.49	0.01	49	4105-56	4105-156
	0.5		1		
	1.001-1.009	0.001	9		
	1.01-1.09	0.01	9		
	1.1-1.9	0.1	9		
	1-24	1	24		
25-100	25	4			

Blocks per set	Gage blocks included in set			Code	
	Size (mm)	Step (mm)	Quantity	Grade 0	Grade 1
47	1.005		1	4105-47A	4105-147A
	1.01-1.09	0.01	9		
	1.1-1.9	0.1	9		
	1-24	1	24		
47	25-100	25	4	4105-47	4105-147
	1.005		1		
	1.01-1.19	0.01	19		
	1.2-1.9	0.1	8		
46	1-9	1	9	4105-46	4105-146
	10-100	10	10		
	1.001-1.009	0.001	9		
	1.01-1.09	0.01	9		
34	1.1-1.9	0.1	9	4105-34	4105-134
	1-9	1	9		
	10-100	10	10		
	1.0005		1		
32	1.001-1.009	0.001	9	4105-32	4105-132
	1.01-1.09	0.01	9		
	1.1-1.9	0.1	9		
	1-9	1	9		
8	10-30	10	3	4105-8	4105-18
	50		1		
	125-175	25	3		
8	200-250	50	2	4105-8	4105-18
	300-500	100	3		



INDIVIDUAL CERAMIC GAGE BLOCKS



4106-A80

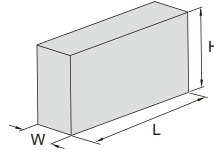

Dimension:

Size (L)	W	H
0.5 ≤ L ≤ 10mm	9mm	30mm
L > 10mm	9mm	35mm

Code explanation:

4106-X□□□□□

- A for grade 0
- B for grade 1

Code examples:

Size (L)	Grade	Code
0.5mm	0	4106-AD5
10mm	1	4106-B10

- Made of ceramic, extremely wear resistance and corrosion resistance
- Meet ISO3650
- Supplied with manufacturer inspection certificate

Size	Code	Size	Code	Size	Code	Size	Code
0.5mm	4106-XD5	1.23mm	4106-X1D23	3mm	4106-X3	17.6mm	4106-X17D6
1mm	4106-X1	1.24mm	4106-X1D24	3.5mm	4106-X3D5	18mm	4106-X18
1.0005mm	4106-X1D0005	1.25mm	4106-X1D25	4mm	4106-X4	18.5mm	4106-X18D5
1.001mm	4106-X1D001	1.26mm	4106-X1D26	4.5mm	4106-X4D5	19mm	4106-X19
1.002mm	4106-X1D002	1.27mm	4106-X1D27	5mm	4106-X5	19.5mm	4106-X19D5
1.003mm	4106-X1D003	1.28mm	4106-X1D28	5.1mm	4106-X5D1	20mm	4106-X20
1.004mm	4106-X1D004	1.29mm	4106-X1D29	5.5mm	4106-X5D5	20.2mm	4106-X20D2
1.005mm	4106-X1D005	1.3mm	4106-X1D3	6mm	4106-X6	20.5mm	4106-X20D5
1.006mm	4106-X1D006	1.31mm	4106-X1D31	6.5mm	4106-X6D5	21mm	4106-X21
1.007mm	4106-X1D007	1.32mm	4106-X1D32	7mm	4106-X7	21.5mm	4106-X21D5
1.008mm	4106-X1D008	1.33mm	4106-X1D33	7.5mm	4106-X7D5	22mm	4106-X22
1.009mm	4106-X1D009	1.34mm	4106-X1D34	7.7mm	4106-X7D7	22.5mm	4106-X22D5
1.01mm	4106-X1D01	1.35mm	4106-X1D35	8mm	4106-X8	22.8mm	4106-X22D8
1.02mm	4106-X1D02	1.36mm	4106-X1D36	8.5mm	4106-X8D5	23mm	4106-X23
1.03mm	4106-X1D03	1.37mm	4106-X1D37	9mm	4106-X9	23.5mm	4106-X23D5
1.04mm	4106-X1D04	1.38mm	4106-X1D38	9.5mm	4106-X9D5	24mm	4106-X24
1.05mm	4106-X1D05	1.39mm	4106-X1D39	10mm	4106-X10	24.5mm	4106-X24D5
1.06mm	4106-X1D06	1.4mm	4106-X1D4	10.3mm	4106-X10D3	25mm	4106-X25
1.07mm	4106-X1D07	1.41mm	4106-X1D41	10.5mm	4106-X10D5	30mm	4106-X30
1.08mm	4106-X1D08	1.42mm	4106-X1D42	11mm	4106-X11	40mm	4106-X40
1.09mm	4106-X1D09	1.43mm	4106-X1D43	11.5mm	4106-X11D5	41.3mm	4106-X41D3
1.1mm	4106-X1D1	1.44mm	4106-X1D44	12mm	4106-X12	50mm	4106-X50
1.11mm	4106-X1D11	1.45mm	4106-X1D45	12.5mm	4106-X12D5	60mm	4106-X60
1.12mm	4106-X1D12	1.46mm	4106-X1D46	12.9mm	4106-X12D9	70mm	4106-X70
1.13mm	4106-X1D13	1.47mm	4106-X1D47	13mm	4106-X13	75mm	4106-X75
1.14mm	4106-X1D14	1.48mm	4106-X1D48	13.5mm	4106-X13D5	80mm	4106-X80
1.15mm	4106-X1D15	1.49mm	4106-X1D49	14mm	4106-X14	90mm	4106-X90
1.16mm	4106-X1D16	1.5mm	4106-X1D5	14.5mm	4106-X14D5	100mm	4106-X100
1.17mm	4106-X1D17	1.6mm	4106-X1D6	15mm	4106-X15	125mm	4106-X125
1.18mm	4106-X1D18	1.7mm	4106-X1D7	15.5mm	4106-X15D5	131.4mm	4106-X131D4
1.19mm	4106-X1D19	1.8mm	4106-X1D8	16mm	4106-X16	150mm	4106-X150
1.2mm	4106-X1D2	1.9mm	4106-X1D9	16.5mm	4106-X16D5		
1.21mm	4106-X1D21	2mm	4106-X2	17mm	4106-X17		
1.22mm	4106-X1D22	2.5mm	4106-X2D5	17.5mm	4106-X17D5		

STEEL GAGE BLOCK SETS

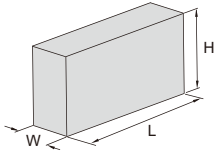

Dimension:

Size (L)	W	H
$0.5 \leq L \leq 10\text{mm}$	9mm	30mm
$L > 10\text{mm}$	9mm	35mm



4100-87

- Made of alloy steel
- Meet ISO3650
- Supplied with manufacturer inspection certificate

Blocks per set	Gage blocks included in set			Code		
	Size (mm)	Step (mm)	Quantity	Grade 0	Grade 1	Grade 2
122	1.0005		1			
	1.001-1.009	0.001	9			
	1.01-1.49	0.01	49			
	1.6-1.9	0.1	4	4100-122	4100-1122	4100-2122
	0.5-24.5	0.5	49			
	30-100	10	8			
	25-75	50	2			
112	1.0005		1			
	1.001-1.009	0.001	9			
	1.01-1.49	0.01	49	4100-112	4100-1112	4100-2112
	0.5-24.5	0.5	49			
	25-100	25	4			
103	1.005		1			
	1.01-1.49	0.01	49	4100-103	4100-1103	4100-2103
	0.5-24.5	0.5	49			
	25-100	25	4			
88	1.0005		1			
	1.001-1.009	0.001	9			
	1.01-1.49	0.01	49	4100-88	4100-188	4100-288
	0.5-9.5	0.5	19			
	10-100	10	10			
87	1.001-1.009	0.001	9			
	1.01-1.49	0.01	49	4100-87	4100-187	4100-287
	0.5-9.5	0.5	19			
	10-100	10	10			
83	0.5		1			
	1		1			
	1.005		1			
	1.01-1.49	0.01	49	4100-83	4100-183	4100-283
	1.5-1.9	0.1	5			
	2-9.5	0.5	16			
	10-100	10	10			
76	1.005		1			
	1.01-1.49	0.01	49			
	0.5-9.5	0.5	19	4100-76	4100-176	4100-276
	10-40	10	4			
	50-100	25	3			

Blocks per set	Gage blocks included in set			Code		
	Size (mm)	Step (mm)	Quantity	Grade 0	Grade 1	Grade 2
56	0.5		1			
	1.001-1.009	0.001	9			
	1.01-1.09	0.01	9	4100-56	4100-156	4100-256
	1.1-1.9	0.1	9			
	1-24	1	24			
	25-100	25	4			
	1.005		1			
47	1.01-1.09	0.01	9			
	1.1-1.9	0.1	9	4100-47A	4100-147A	4100-247A
	1-24	1	24			
	25-100	25	4			
47	1.005		1			
	1.01-1.19	0.01	19			
	1.2-1.9	0.1	8	4100-47	4100-147	4100-247
	1-9	1	9			
	10-100	10	10			
46	1.001-1.009	0.001	9			
	1.01-1.09	0.01	9			
	1.1-1.9	0.1	9	4100-46	4100-146	4100-246
	1-9	1	9			
	10-100	10	10			
34	1.0005		1			
	1.001-1.009	0.001	9			
	1.01-1.09	0.01	9	4100-34	4100-134	4100-234
	1.1-1.9	0.1	9			
	1-5	1	5			
32	10		1			
	1.005		1			
	1.01-1.09	0.01	9			
	1.1-1.9	0.1	9	4100-32	4100-132	4100-232
	1-9	1	9			
	10-30	10	3			
	50		1			
9	1.001-1.009	0.001	9	4100-9	4100-19	4100-29
9	0.991-0.999	0.001	9	4100-9A	4100-19A	4100-29A
8	125-175	25	3			
	200-250	50	2	4100-8	4100-18	4100-28
	300-500	100	3			

CUSTOM-MADE

CAN SUPPLY ANY SIZES FROM 0.5 TO 1000MM, SUCH AS 72.672MM
 SIZE<100MM: MOQ 6PCS PER SIZE
 SIZE>100MM: MOQ 3PCS PER SIZE

INDIVIDUAL STEEL GAGE BLOCKS



4101-A70

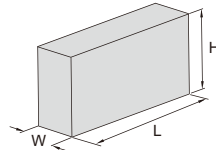

Dimension:

Size (L)	W	H
0.5 ≤ L ≤ 10mm	9mm	30mm
L > 10mm	9mm	35mm

Code explanation:

4101-X□□□□□

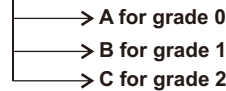

Code examples:

Size (L)	Grade	Code
0.5mm	0	4101-AD5
1mm	1	4101-B1
10.5mm	2	4101-C10D5

- Made of alloy steel
- Meet ISO3650
- Supplied with manufacturer inspection certificate

Size	Code	Size	Code	Size	Code	Size	Code
0.5mm	4101-XD5	1.19mm	4101-X1D19	3.5mm	4101-X3D5	20.2mm	4101-X20D2
0.991mm	4101-XD991	1.2mm	4101-X1D2	4mm	4101-X4	20.5mm	4101-X20D5
0.992mm	4101-XD992	1.21mm	4101-X1D21	4.5mm	4101-X4D5	21mm	4101-X21
0.993mm	4101-XD993	1.22mm	4101-X1D22	5mm	4101-X5	21.5mm	4101-X21D5
0.994mm	4101-XD994	1.23mm	4101-X1D23	5.1mm	4101-X5D1	22mm	4101-X22
0.995mm	4101-XD995	1.24mm	4101-X1D24	5.5mm	4101-X5D5	22.5mm	4101-X22D5
0.996mm	4101-XD996	1.25mm	4101-X1D25	6mm	4101-X6	22.8mm	4101-X22D8
0.997mm	4101-XD997	1.26mm	4101-X1D26	6.5mm	4101-X6D5	23mm	4101-X23
0.998mm	4101-XD998	1.27mm	4101-X1D27	7mm	4101-X7	23.5mm	4101-X23D5
0.999mm	4101-XD999	1.28mm	4101-X1D28	7.5mm	4101-X7D5	24mm	4101-X24
1mm	4101-X1	1.29mm	4101-X1D29	7.7mm	4101-X7D7	24.5mm	4101-X24D5
1.0005mm	4101-X1D0005	1.3mm	4101-X1D3	8mm	4101-X8	25mm	4101-X25
1.001mm	4101-X1D001	1.31mm	4101-X1D31	8.5mm	4101-X8D5	30mm	4101-X30
1.002mm	4101-X1D002	1.32mm	4101-X1D32	9mm	4101-X9	35mm	4101-X35
1.003mm	4101-X1D003	1.33mm	4101-X1D33	9.5mm	4101-X9D5	40mm	4101-X40
1.004mm	4101-X1D004	1.34mm	4101-X1D34	10mm	4101-X10	41.3mm	4101-X41D3
1.005mm	4101-X1D005	1.35mm	4101-X1D35	10.3mm	4101-X10D3	45mm	4101-X45
1.006mm	4101-X1D006	1.36mm	4101-X1D36	10.5mm	4101-X10D5	50mm	4101-X50
1.007mm	4101-X1D007	1.37mm	4101-X1D37	11mm	4101-X11	60mm	4101-X60
1.008mm	4101-X1D008	1.38mm	4101-X1D38	11.5mm	4101-X11D5	70mm	4101-X70
1.009mm	4101-X1D009	1.39mm	4101-X1D39	12mm	4101-X12	75mm	4101-X75
1.01mm	4101-X1D01	1.4mm	4101-X1D4	12.5mm	4101-X12D5	80mm	4101-X80
1.02mm	4101-X1D02	1.41mm	4101-X1D41	12.9mm	4101-X12D9	90mm	4101-X90
1.03mm	4101-X1D03	1.42mm	4101-X1D42	13mm	4101-X13	100mm	4101-X100
1.04mm	4101-X1D04	1.43mm	4101-X1D43	13.5mm	4101-X13D5	125mm	4101-X125
1.05mm	4101-X1D05	1.44mm	4101-X1D44	14mm	4101-X14	131.4mm	4101-X131D4
1.06mm	4101-X1D06	1.45mm	4101-X1D45	14.5mm	4101-X14D5	150mm	4101-X150
1.07mm	4101-X1D07	1.46mm	4101-X1D46	15mm	4101-X15	175mm	4101-X175
1.08mm	4101-X1D08	1.47mm	4101-X1D47	15.5mm	4101-X15D5	200mm	4101-X200
1.09mm	4101-X1D09	1.48mm	4101-X1D48	16mm	4101-X16	250mm	4101-X250
1.1mm	4101-X1D1	1.49mm	4101-X1D49	16.5mm	4101-X16D5	300mm	4101-X300
1.11mm	4101-X1D11	1.5mm	4101-X1D5	17mm	4101-X17	400mm	4101-X400
1.12mm	4101-X1D12	1.6mm	4101-X1D6	17.5mm	4101-X17D5	500mm	4101-X500
1.13mm	4101-X1D13	1.7mm	4101-X1D7	17.6mm	4101-X17D6	600mm	4101-X600
1.14mm	4101-X1D14	1.8mm	4101-X1D8	18mm	4101-X18	700mm	4101-X700
1.15mm	4101-X1D15	1.9mm	4101-X1D9	18.5mm	4101-X18D5	750mm	4101-X750
1.16mm	4101-X1D16	2mm	4101-X2	19mm	4101-X19	800mm	4101-X800
1.17mm	4101-X1D17	2.5mm	4101-X2D5	19.5mm	4101-X19D5	900mm	4101-X900
1.18mm	4101-X1D18	3mm	4101-X3	20mm	4101-X20	1000mm	4101-X1000

CARBIDE GAGE BLOCK SETS

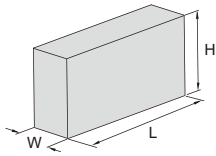

Dimension:

Size (L)	W	H
$0.5 \leq L \leq 10\text{mm}$	9mm	30mm
$L > 10\text{mm}$	9mm	35mm

- Made of carbide, extremely wear resistance and corrosion resistance, excellent dimension stability
- Meet ISO3650
- Supplied with manufacturer inspection certificate



4164-32

Blocks per set	Gage blocks included in set			Code	
	Size (mm)	Step (mm)	Quantity	Grade 0	Grade 1
122	1.0005		1	4164-122	4164-1122
	1.001-1.009	0.001	9		
	1.01-1.49	0.01	49		
	1.6-1.9	0.1	4		
	0.5-24.5	0.5	49		
	30-100	10	8		
	25-75	50	2		
112	1.0005		1	4164-112	4164-1112
	1.001-1.009	0.001	9		
	1.01-1.49	0.01	49		
	0.5-24.5	0.5	49		
	25-100	25	4		
103	1.005		1	4164-103	4164-1103
	1.01-1.49	0.01	49		
	0.5-24.5	0.5	49		
	25-100	25	4		
87	1.001-1.009	0.001	9	4164-87	4164-187
	1.01-1.49	0.01	49		
	0.5-9.5	0.5	19		
	10-100	10	10		
83	0.5		1	4164-83	4164-183
	1		1		
	1.005		1		
	1.01-1.49	0.01	49		
	1.5-1.9	0.1	5		
	2-9.5	0.5	16		
	10-100	10	10		

Blocks per set	Gage blocks included in set			Code	
	Size (mm)	Step (mm)	Quantity	Grade 0	Grade 1
76	1.005		1	4164-76	4164-176
	1.01-1.49	0.01	49		
	0.5-9.5	0.5	19		
	10-40	10	4		
	50-100	25	3		
47	1.005		1	4164-47A	4164-147A
	1.01-1.09	0.01	9		
	1.1-1.9	0.1	9		
	1-24	1	24		
47	1.005		1	4164-47	4164-147
	1.01-1.19	0.01	19		
	1.2-1.9	0.1	8		
	1-9	1	9		
	10-100	10	10		
46	1.001-1.009	0.001	9	4164-46	4164-146
	1.01-1.09	0.01	9		
	1.1-1.9	0.1	9		
	1-9	1	9		
	10-100	10	10		
32	1.005		1	4164-32	4164-132
	1.01-1.09	0.01	9		
	1.1-1.9	0.1	9		
	1-9	1	9		
	10-30	10	3		
	50		1		

WEAR BLOCK SETS



- Protect the measuring surfaces of gage blocks from excessive wear
- Meet ISO3650
- Supplied with manufacturer inspection certificate

Blocks per set	Size	Material	Code	
			Grade 0	Grade 1
2	1.0mm	ceramic	4111-1	4111-11
2	1.0mm	alloy steel	4111-1A	4111-11A
2	2.0mm	ceramic	4111-2	4111-12
2	2.0mm	alloy steel	4111-2A	4111-12A

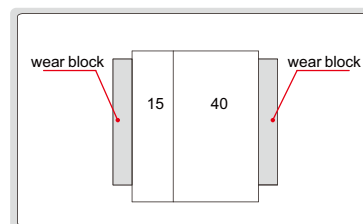

4111-2



MICROMETER INSPECTION GAGE BLOCK SETS



4107-10

- One piece of optical flat is included in 4107-10, 4107-101
- Meet ISO3650/grade 0
- Supplied with manufacturer inspection certificate

Code	Material	Gage blocks included in set	Applicable micrometer	Optical flat
4107-10	ceramic	2.5mm, 5.1mm, 7.7mm, 10.3mm, 12.9mm, 15mm, 17.6mm, 20.2mm, 22.8mm, 25mm, optical flat	0-25mm	included
4107-101	alloy steel	2.5mm, 5.1mm, 7.7mm, 10.3mm, 12.9mm, 15mm, 17.6mm, 20.2mm, 22.8mm, 25mm, optical flat	0-25mm	included
4107-112	alloy steel	25mm, 27.5mm, 30.1mm, 32.7mm, 35.3mm, 37.9mm, 40mm, 42.6mm, 45.2mm, 47.8mm, 50mm	25-50mm	not included
4107-113	alloy steel	50mm, 52.5mm, 55.1mm, 57.7mm, 60.3mm, 62.9mm, 65mm, 67.6mm, 70.2mm, 72.8mm, 75mm	50-75mm	not included
4107-114	alloy steel	75mm, 77.5mm, 80.1mm, 82.7mm, 85.3mm, 87.9mm, 90mm, 92.6mm, 95.2mm, 97.8mm, 100mm	75-100mm	not included

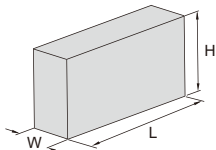

Dimension:

Size (L)	W	H
$0.5 \leq L \leq 10\text{mm}$	9mm	30mm
$L > 10\text{mm}$	9mm	35mm



CALIPER INSPECTION GAGE BLOCK SET



4108-3005

- Meet ISO3650/grade 2
- Supplied with manufacturer inspection certificate

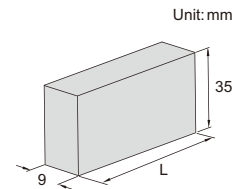

(mm)

Code	Material	Blocks per set	Gage blocks included in set (L)	Applicable calipers
4108-3005	alloy steel	5	30, 41.3, 131.4, 243.5, 281.2	0-150, 0-200, 0-300

- Made of aluminum
- To be used with individual steel gage block (code 4101) as Go and No-Go gage

Code	Applicable gage block size
6883-1	1.5-5mm
6883-2	5-10mm
6883-3	10-15mm
6883-4	15-20mm
6883-5	20-25mm



6883-4

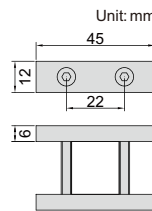

GAGE BLOCK HOLDERS

To be used as Go and No-Go gage

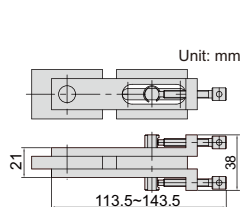

Code
6886-1



6886-1



GAGE BLOCK HOLDER

- For gage blocks over 100mm with clamping holes
- Optional accessory: gage block holder accessory, gage block accessory (code 6881)

application

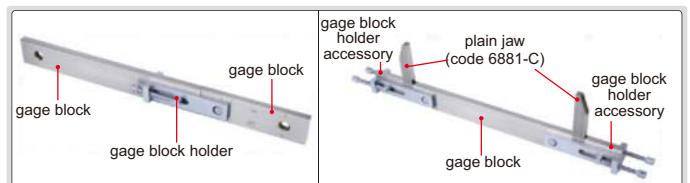

GAGE BLOCK HOLDER ACCESSORY

Code
6886-A

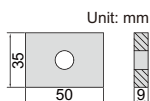

6886-A

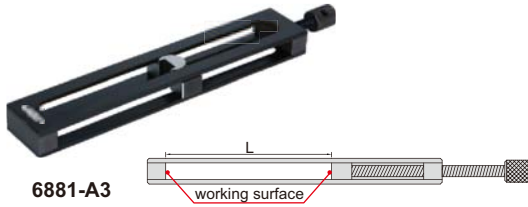

Code	Name	Clamping range * (L)
6881-A1	holder	0-25mm
6881-A2	holder	25-50mm
6881-A3	holder	50-100mm
6881-A4	holder	100-200mm
6881-A5	holder	200-300mm
6881-A6**	holder	300-500mm

* The actual clamping range should deduct the width of jaws
 ** Not suitable for base 6881-B



Code	Name	Remark
6881-F	scriber	made of carbide

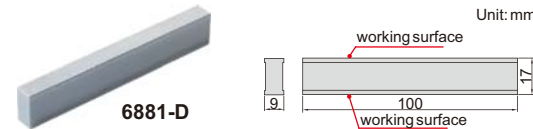

Code	Name	Remark
6881-D	parallel jaw	made of carbide



GAGE BLOCK ACCESSORY SET

Code	Mark
6881-S17	17pcs (including the below items)

holder, 0-25mm (code 6881-A1)	1pc
holder, 25-50mm (code 6881-A2)	1pc
holder, 50-100mm (code 6881-A3)	1pc
holder, 100-200mm (code 6881-A4)	1pc
holder, 200-300mm (code 6881-A5)	1pc
base (code 6881-B)	1pc
plain jaw (code 6881-C)	1 pair
parallel jaw (code 6881-D)	1pc
half round jaw, 2.5mm (code 6881-E1)	1 pair
half round jaw, 5.0mm (code 6881-E2)	1 pair
half round jaw, 6.0mm (code 6881-E3)	1 pair
scriber (code 6881-F)	1pc
centre point (code 6881-G)	1pc

GAGE BLOCK ACCESSORIES

Code	Name
6881-B	base

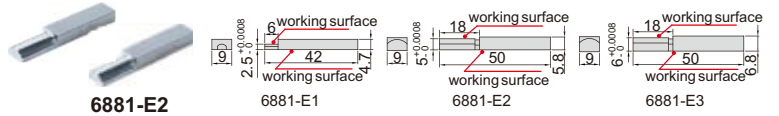
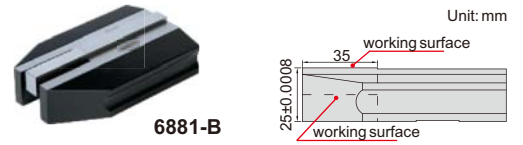

Code	Name	Size	Remark
6881-E1	half round jaw	2.5mm	made of carbide, supplied in pair
6881-E2	half round jaw	5.0mm	made of carbide, supplied in pair
6881-E3	half round jaw	6.0mm	made of carbide, supplied in pair

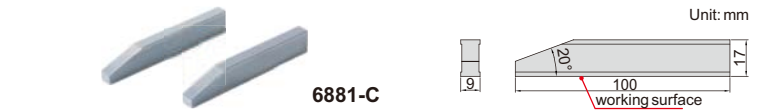

Code	Name	Remark
6881-C	plain jaw	made of carbide, supplied in pair



Code	Name	Remark
6881-G	centre point	the tip is made of carbide

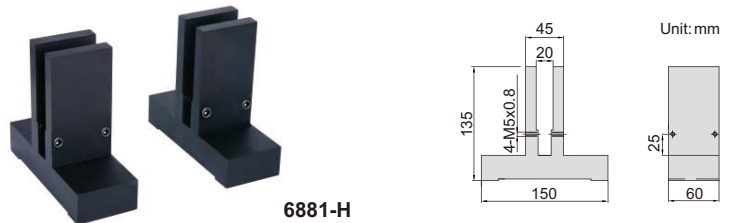

Code	Name	Remark
6881-H	base for holder	supplied in pair

application

**CUSTOM-MADE
CAN SUPPLY ANY LENGTH, SUCH AS 80.672MM**

CYLINDER GAGE BLOCKS

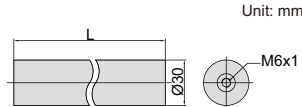

- Made of special alloy steel, hardness HRC64, high stability, wear resistance and easy combination
- Meet ISO3650 grade 1
- Can be connected with M6x1 screw and combined to any sizes up to 4m

Code	Length (L)
4001-25*	25mm
4001-50*	50mm
4001-75*	75mm
4001-100*	100mm
4001-200*	200mm
4001-300*	300mm
4001-400*	400mm
4001-500*	500mm

* Supplied with manufacturer inspection certificate

can be combined to any sizes up to 4m

Combination 1: combined by several standard size cylinder gage blocks and one custom size cylinder gage block
For example: 500 (standard) + 200 (standard) + 25.832 (custom)=725.832mm
Note: in order to reduce cost, custom size should be within 100mm

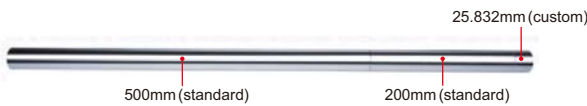

Combination 2: combined by standard size cylinder gage blocks and rectangular gage blocks
For example: 500 (cylinder) + 200 (cylinder) + 21.5 (rectangular) + 2.33 (rectangular) + 2.002 (rectangular)=725.832mm

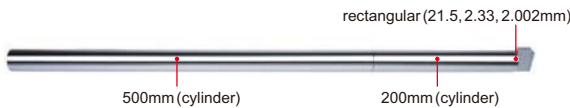

high stability in vertical position, suitable for checking height gages



connected with M6x1 screw

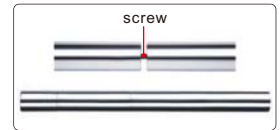

INTERNAL BLOCKS



4001-A

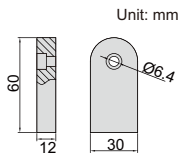

- Can be attached to cylinder and rectangular gage blocks
- Made of special alloy steel, hardness HRC64, high stability, wear resistance and easy combination
- Supplied in a matched pair

Code	Size	Flatness
4001-A	12mm	0.2µm

Combination 1: combined by several standard size cylinder gage blocks and one custom size cylinder gage block
For example: 500 (standard) + 200 (standard) + 25.832 (custom)=725.832mm
Note: in order to reduce cost, custom size should be within 100mm

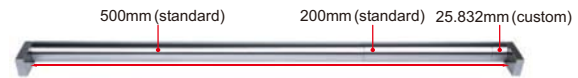

Combination 2: combined by standard size cylinder gage blocks and rectangular gage blocks
For example: 500 (cylinder) + 200 (cylinder) + 50 (cylinder) + 20 (rectangular) - 2.16 (rectangular) - 2.008 (rectangular)=725.832mm

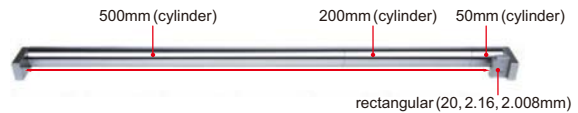

BASE



4001-B

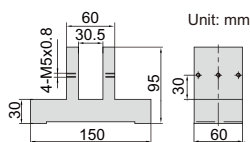

Code	Remark
4001-B	supplied in pair

working with base

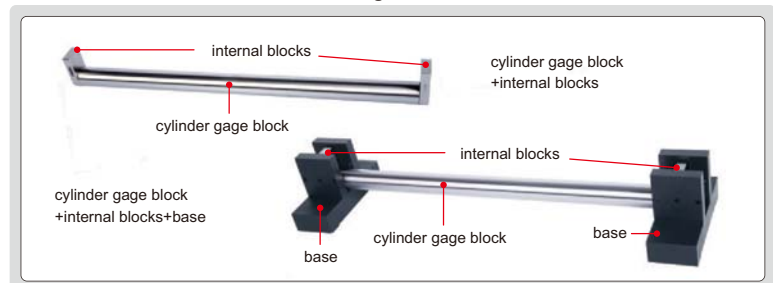

CALIPER/HEIGHT GAGE CHECKERS



- To check calipers and height gages
- Constructed with steel gage blocks

check upper jaws of caliper

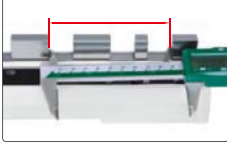

check lower jaws of caliper

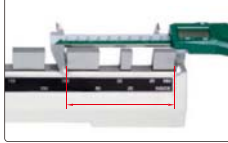

check height gage

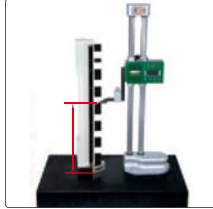

horizontal

vertical



6884-300

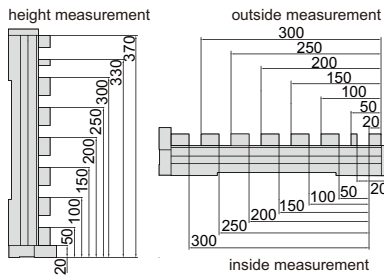

6884-300

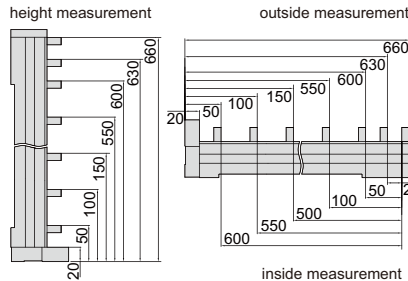

6884-600

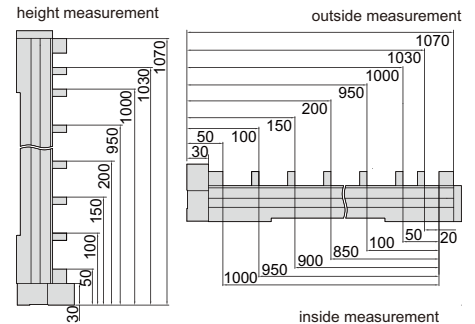

6884-1000

Unit: mm

Code	Size	Range of inside measurement	Range of outside measurement	Range of height measurement	Accuracy
6884-300*	0-300mm	20, 50, 100, 150, 200, 250, 300	20, 50, 100, 150, 200, 250, 300	20, 50, 100, 150, 200, 250, 300, 330, 370	±5μm
6884-600*	0-600mm	20, 50, 100, 150, 200, 250, 300, 350, 400, 450, 500, 550, 600	20, 50, 100, 150, 200, 250, 300, 350, 400, 450, 500, 550, 600, 630, 660	20, 50, 100, 150, 200, 250, 300, 350, 400, 450, 500, 550, 600, 630, 660	±7μm
6884-1000*	0-1000mm	20, 50, 100, 150, 200, 250, 300, 350, 400, 450, 500, 550, 600, 650, 700, 750, 800, 850, 900, 950, 1000	30, 50, 100, 150, 200, 250, 300, 350, 400, 450, 500, 550, 600, 650, 700, 750, 800, 850, 900, 950, 1000, 1030, 1070	30, 50, 100, 150, 200, 250, 300, 350, 400, 450, 500, 550, 600, 650, 700, 750, 800, 850, 900, 950, 1000, 1030, 1070	±7μm

(mm)

* Supplied with manufacturer inspection certificate

INSIDE MICROMETER ACCESSORIES



6884-A3

- Supplied with a pair of 5mm carbide gage blocks, ISO3650 grade 0

Code	Applicable caliper/height gage checker
6884-A3*	0-300mm
6884-A6*	0-600mm
6884-A10*	0-1000mm

* Supplied with manufacturer inspection certificate

set inside micrometer



CHECK MASTERS



- To check the accuracy of table movement of machine tools, to calibrate height gages and CMMs
- Ceramic gage blocks
- Can be used in either vertical and horizontal orientation
- Supplied with manufacturer inspection certificate

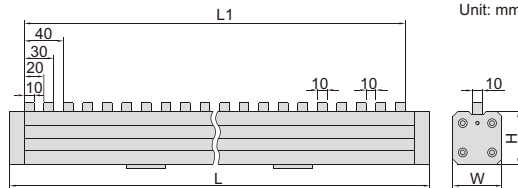

6882-600A



horizontal orientation



vertical orientation

Code	Range	Step	Accuracy	Parallelism of blocks	L	L1	H	W
6882-300A	300mm	10mm	±2.5μm	1.2μm	350	310	49	45
6882-450A	450mm	10mm	±3.5μm	1.5μm	510	470	54	50
6882-600A	600mm	10mm	±3.5μm	1.5μm	650	610	54	50

ANGLE GAGE BLOCK SETS



4109-7A

- Standard for angle measurement
- Accuracy $\pm 10''$

Code	Blocks per set	Angle	Step	Quantity
4109-7A	7	15°10'		1
		30°20'		1
		45°30'		1
		50°		1
		60°40'		1
		75°50'		1
		90°/90°/90°/90°		1
4109-36A	36	10°-20°	1°	11
		30°-70°	10°	5
		45°		1
		15°10'-15°50'	10'	5
		15°1'-15°9'	1'	9
		10°00'30"		1
		80°/81°/100°/99°		1
		89°10'/89°20'/90°50'/90°40'		1
		89°30'/89°40'/90°30'/90°20'		1
		90°/90°/90°/90°		1

ANGLE GAGE BLOCKS



4002-15



Individual

Code	Angle (α)	H (mm)
4002-A1 *	1°	11.5
4002-A3 *	3°	14.0
4002-A5 *	5°	16.5
4002-A9 *	9°	22.0
4002-A15 *	15°	30.5
4002-A27 *	27°	48.0
4002-A30 *	30°	53.5
4002-A41 *	41°	75.0
4002-A45 *	45°	84.0
4002-B1 *	1'	10.0
4002-B3 *	3'	10.0
4002-B5 *	5'	10.0
4002-B9 *	9'	10.0
4002-B20 *	20'	10.0
4002-B27 *	27'	10.0
4002-B30 *	30'	10.0
4002-C6 *	6"	10.0
4002-C12 *	12"	10.0
4002-C18 *	18"	10.0
4002-C30 *	30"	10.0
4002-D *	90°/90°/90°/90°	75.0

set angle of plate



inspect angle



Unit: mm

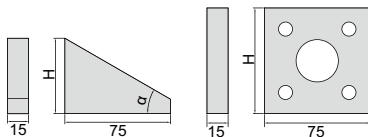

combination

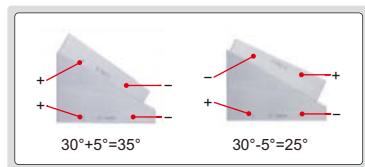

- Accuracy: $\pm 2''$
- To inspect protractor, taper gage, index plate, index head and goniometer, can also be used to set angle
- Made of special alloy steel, hardness HRC64, high stability, wear resistance and easy combination
- Can be combined to any angle with interval 6 seconds after combination (6", 12", 18", ... , 360°)

Set

Code	Angle (α)	Total Quantity
4002-13 *	1°, 3°, 9°, 27°, 41°, 1', 3', 9', 27', 6", 18", 30", 90°/90°/90°/90°	13
4002-15 *	1°, 3°, 5°, 15°, 30°, 45°, 1', 3', 5', 20', 30', 6", 12", 30", 90°/90°/90°/90°	15

* Supplied with manufacturer inspection certificate

PIN GAGE SETS

- Meet DIN2267, grade 1
- Made of alloy steel
- Hardness HRC62-65
- Diameter accuracy: $\pm 1\mu\text{m}$



4166-6D

Code	Diameter $\varnothing d$ (mm)	Step	Pin gages per set
4166-2S	1.00, 1.01, 1.02, ..., 2.00	0.01mm	101
4166-3S	2.00, 2.01, 2.02, ..., 3.00	0.01mm	101
4166-4S	3.00, 3.01, 3.02, ..., 4.00	0.01mm	101
4166-5S	4.00, 4.01, 4.02, ..., 5.00	0.01mm	101
4166-6S	5.00, 5.01, 5.02, ..., 6.00	0.01mm	101
4166-7S	6.00, 6.01, 6.02, ..., 7.00	0.01mm	101
4166-8S	7.00, 7.01, 7.02, ..., 8.00	0.01mm	101
4166-9S	8.00, 8.01, 8.02, ..., 9.00	0.01mm	101
4166-10S	9.00, 9.01, 9.02, ..., 10.00	0.01mm	101

Unit: mm



Code	Diameter $\varnothing d$ (mm)	Step	Pin gages per set
4166-411	1.0, 1.1, 1.2, ..., 5.0	0.1mm	41
4166-511	5.0, 5.1, 5.2, ..., 10.0	0.1mm	51
4166-512	10.0, 10.1, 10.2, ..., 15.0	0.1mm	51
4166-513	15.0, 15.1, 15.2, ..., 20.0	0.1mm	51

Code	Diameter $\varnothing d$ (mm)	Step	Pin gages per set
4166-0D	0.20, 0.21, 0.22, ..., 0.50	0.01mm	31
4166-1	0.50, 0.51, 0.52, ..., 1.00	0.01mm	51
4166-1D	1.00, 1.01, 1.02, ..., 1.50	0.01mm	51
4166-2	1.50, 1.51, 1.52, ..., 2.00	0.01mm	51
4166-2D	2.00, 2.01, 2.02, ..., 2.50	0.01mm	51
4166-3	2.50, 2.51, 2.52, ..., 3.00	0.01mm	51
4166-3D	3.00, 3.01, 3.02, ..., 3.50	0.01mm	51
4166-4	3.50, 3.51, 3.52, ..., 4.00	0.01mm	51
4166-4D	4.00, 4.01, 4.02, ..., 4.50	0.01mm	51
4166-5	4.50, 4.51, 4.52, ..., 5.00	0.01mm	51
4166-5D	5.00, 5.01, 5.02, ..., 5.50	0.01mm	51
4166-6	5.50, 5.51, 5.52, ..., 6.00	0.01mm	51
4166-6D	6.00, 6.01, 6.02, ..., 6.50	0.01mm	51
4166-7	6.50, 6.51, 6.52, ..., 7.00	0.01mm	51
4166-7D	7.00, 7.01, 7.02, ..., 7.50	0.01mm	51
4166-8	7.50, 7.51, 7.52, ..., 8.00	0.01mm	51
4166-8D	8.00, 8.01, 8.02, ..., 8.50	0.01mm	51
4166-9	8.50, 8.51, 8.52, ..., 9.00	0.01mm	51
4166-9D	9.00, 9.01, 9.02, ..., 9.50	0.01mm	51
4166-10	9.50, 9.51, 9.52, ..., 10.00	0.01mm	51

Code	Diameter $\varnothing d$ (mm)	Step	Pin gages per set
4166-10D	10.00, 10.01, 10.02, ..., 10.50	0.01mm	51
4166-11	10.50, 10.51, 10.52, ..., 11.00	0.01mm	51
4166-11D	11.00, 11.01, 11.02, ..., 11.50	0.01mm	51
4166-12	11.50, 11.51, 11.52, ..., 12.00	0.01mm	51
4166-12D	12.00, 12.01, 12.02, ..., 12.50	0.01mm	51
4166-13	12.50, 12.51, 12.52, ..., 13.00	0.01mm	51
4166-13D	13.00, 13.01, 13.02, ..., 13.50	0.01mm	51
4166-14	13.50, 13.51, 13.52, ..., 14.00	0.01mm	51
4166-14D	14.00, 14.01, 14.02, ..., 14.50	0.01mm	51
4166-15	14.50, 14.51, 14.52, ..., 15.00	0.01mm	51
4166-15D	15.00, 15.01, 15.02, ..., 15.50	0.01mm	51
4166-16	15.50, 15.51, 15.52, ..., 16.00	0.01mm	51
4166-16D	16.00, 16.01, 16.02, ..., 16.50	0.01mm	51
4166-17	16.50, 16.51, 16.52, ..., 17.00	0.01mm	51
4166-17D	17.00, 17.01, 17.02, ..., 17.50	0.01mm	51
4166-18	17.50, 17.51, 17.52, ..., 18.00	0.01mm	51
4166-18D	18.00, 18.01, 18.02, ..., 18.50	0.01mm	51
4166-19	18.50, 18.51, 18.52, ..., 19.00	0.01mm	51
4166-19D	19.00, 19.01, 19.02, ..., 19.50	0.01mm	51
4166-20	19.50, 19.51, 19.52, ..., 20.00	0.01mm	51

CAN SUPPLY PIN GAGE
LENGTH FROM 10 TO 150mm



CUSTOM-MADE PIN GAGES

- Meet DIN2267, grade 1
- Custom-made pin gages, diameter range $\varnothing 0.200\sim\varnothing 30.000\text{mm}$ with three decimal, for example 0.211mm, 5.562mm, 16.298mm
- Diameter accuracy: $\pm 1\mu\text{m}$
- Made of alloy steel
- Hardness HRC62-65
- Optional accessory: wooden box

Ordering examples:

Diameter	Code
0.211mm	4118-0D211
5.562mm	4118-5D562
16.298mm	4118-16D298

Note: "D" stands for "."

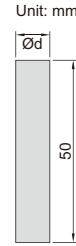

4118-8D015

Code	Diameter range $\varnothing d$ (mm)
4118-xxxx *	0.200~30.000

* Supplied with manufacturer inspection certificate

INDIVIDUAL PIN GAGES

- Meet DIN2267, grade 1
- Diameter range: $\varnothing 0.20\sim\varnothing 20.00\text{mm}$
- Diameter accuracy: $\pm 1\mu\text{m}$
- Made of alloy steel
- Hardness HRC62-65
- Optional accessory: wooden box

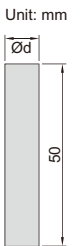

4110-9D98

Diameter $\varnothing d$ (mm)	Diameter $\varnothing d$ (mm)
0.20, 0.21, 0.22, 0.23, ..., 1.00	10.01, 10.02, 10.03, 10.04, ..., 11.00
1.01, 1.02, 1.03, 1.04, ..., 2.00	11.01, 11.02, 11.03, 11.04, ..., 12.00
2.01, 2.02, 2.03, 2.04, ..., 3.00	12.01, 12.02, 12.03, 12.04, ..., 13.00
3.01, 3.02, 3.03, 3.04, ..., 4.00	13.01, 13.02, 13.03, 13.04, ..., 14.00
4.01, 4.02, 4.03, 4.04, ..., 5.00	14.01, 14.02, 14.03, 14.04, ..., 15.00
5.01, 5.02, 5.03, 5.04, ..., 6.00	15.01, 15.02, 15.03, 15.04, ..., 16.00
6.01, 6.02, 6.03, 6.04, ..., 7.00	16.01, 16.02, 16.03, 16.04, ..., 17.00
7.01, 7.02, 7.03, 7.04, ..., 8.00	17.01, 17.02, 17.03, 17.04, ..., 18.00
8.01, 8.02, 8.03, 8.04, ..., 9.00	18.01, 18.02, 18.03, 18.04, ..., 19.00
9.01, 9.02, 9.03, 9.04, ..., 10.00	19.01, 19.02, 19.03, 19.04, ..., 20.00

Code
4110-xxxx

Ordering examples:

Diameter	Code
0.21mm	4110-0D21
5.56mm	4110-5D56
16.00mm	4110-16D00

Note : "D" stands for "."

BOXES FOR PIN GAGES

- For individual pin gages (4110 and 4118 series)



7340

Code	Applicable pin gage diameter $\varnothing d$ (mm)	Quantity of pin gages
7340	0.20-10.00	51pcs
7340-101	0.20-10.00	101pcs
7340-201	10.00-15.00	51pcs
7340-202	15.00-20.00	51pcs

PIN GAGE HANDLES

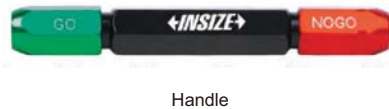
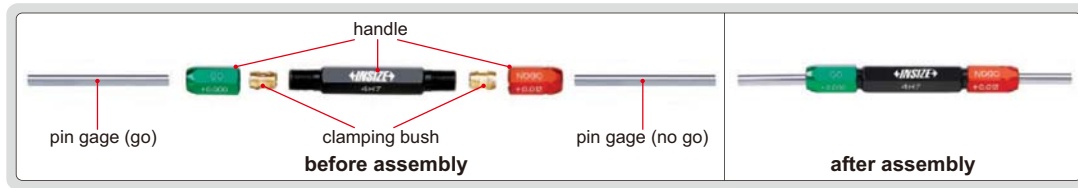

clamping bush

- Wrench is needed to install pins
- Clamping bushes (0.2~7.14mm) are made of brass, clamping bushes (7.14~20.62mm) are made of aluminum

Code	Applicable pin gage diameter (mm)	Including	
		Handle	Clamping bush (mm)
7341-0S	0.2-1.02	1pc	6 pairs (the clamping range are 0.2-0.38, 0.38-0.51, 0.51-0.64, 0.64-0.76, 0.76-0.89, 0.89-1.02)
7341-1S	1.02-1.91	1pc	7 pairs (the clamping range are 1.02-1.14, 1.14-1.27, 1.27-1.40, 1.40-1.52, 1.52-1.65, 1.65-1.78, 1.78-1.91)
7341-2S	1.91-3.33	1pc	8 pairs (the clamping range are 1.91-2.08, 2.08-2.26, 2.26-2.44, 2.44-2.62, 2.62-2.79, 2.79-2.97, 2.97-3.15, 3.15-3.33)
7341-3S	3.33-4.57	1pc	7 pairs (the clamping range are 3.33-3.51, 3.51-3.68, 3.68-3.86, 3.86-4.04, 4.04-4.22, 4.22-4.39, 4.39-4.57)
7341-4S	4.57-5.79	1pc	6 pairs (the clamping range are 4.57-4.78, 4.78-4.98, 4.98-5.18, 5.18-5.38, 5.38-5.59, 5.59-5.79)
7341-5S	5.79-7.14	1pc	6 pairs (the clamping range are 5.79-5.99, 5.99-6.20, 6.20-6.40, 6.40-6.63, 6.63-6.88, 6.88-7.14)

Code	Applicable pin gage diameter (mm)	Including	
		Handle	Clamping bush (mm)
7341-6S	7.14-8.66	1pc	6 pairs (the clamping range are 7.14-7.39, 7.39-7.65, 7.65-7.90, 7.90-8.15, 8.15-8.41, 8.41-8.66)
7341-7S	8.66-10.31	1pc	6 pairs (the clamping range are 8.66-8.92, 8.9-9.17, 9.17-9.42, 9.42-9.70, 9.70-10.01, 10.01-10.31)
7341-8S	10.31-11.81	1pc	4 pairs (the clamping range are 10.31-10.67, 10.67-11.05, 11.05-11.43, 11.43-11.81)
7341-9S	11.81-12.95	1pc	3 pairs (the clamping range are 11.81-12.19, 12.19-12.57, 12.57-12.95)
7341-10S	12.95-14.71	1pc	4 pairs (the clamping range are 12.95-13.51, 13.51-13.89, 13.89-14.30, 14.30-14.71)
7341-11S	14.71-16.13	1pc	4 pairs (the clamping range are 14.71-15.09, 15.09-15.49, 15.49-15.88, 15.88-16.13)
7341-12S	16.13-17.88	1pc	4 pairs (the clamping range are 16.13-16.66, 16.66-17.07, 17.07-17.48, 17.48-17.88)
7341-13S	17.88-19.30	1pc	4 pairs (the clamping range are 17.88-18.26, 18.26-18.67, 18.67-19.05, 19.05-19.30)
7341-14S	19.30-20.62	1pc	2 pairs (the clamping range are 19.30-19.84, 19.84-20.62)

PLAIN PLUG GAGES

CUSTOM-MADE

OTHER CLASSES ARE AVAILABLE, SUCH AS H8, H9
OTHER DIAMETERS ARE AVAILABLE, SUCH AS 19.003mm
OTHER LENGTHS ARE AVAILABLE, SUCH AS 70mm

- Supplied with Go and No-Go gages together
- Class H7
- Hardness HRC 60±2
- Standard DIN7150-2

Size tolerance of H7

Diameter Ød	Size tolerance of Go gage (µm)	Size tolerance of No-Go gage (µm)	L1	L2	L	S1, S2	(mm)
≥2, ≤3	+0.5 / +2.5	+9 / +11	6.5	4.5	62	–	
>3, ≤6	+0.75 / +3.25	+10.75 / +13.25	8	6	74	–	
>6, ≤10	+0.75 / +3.25	+13.75 / +16.25	10	7	87	–	
>10, ≤14	+1 / +4	+16.5 / +19.5	12	8	99	–	
>14, ≤18	+1 / +4	+16.5 / +19.5	14	10	114	–	
>18, ≤24	+1 / +5	+19 / +23	16	12	132	–	
>24, ≤30	+1 / +5	+19 / +23	18	14	136	–	
>30, ≤40	+1.5 / +5.5	+23 / +27	20	15	155	–	
>40, ≤50	+1.5 / +5.5	+23 / +27	25	18	169	–	
>50, ≤65	+1.5 / +6.5	+27.5 / +32.5	30	18	–	164, 152	
>65, ≤80	+1.5 / +6.5	+27.5 / +32.5	35	25	–	169, 159	
>80, ≤100	+2 / +8	+32 / +38	35	25	–	169, 159	

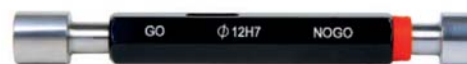

4124-12



Type A

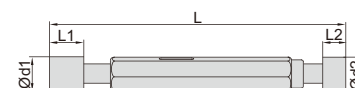

Type A



Type B

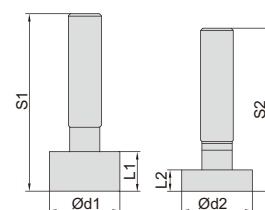

Type B

Code	Diameter (mm)	Type	Code	Diameter (mm)	Type	Code	Diameter (mm)	Type	Code	Diameter (mm)	Type
4124-2	2	A	4124-17	17	A	4124-32	32	A	4124-47	47	A
4124-3	3	A	4124-18	18	A	4124-33	33	A	4124-48	48	A
4124-4	4	A	4124-19	19	A	4124-34	34	A	4124-49	49	A
4124-5	5	A	4124-20	20	A	4124-35	35	A	4124-50	50	A
4124-6	6	A	4124-21	21	A	4124-36	36	A	4124-52	52	B
4124-7	7	A	4124-22	22	A	4124-37	37	A	4124-55	55	B
4124-8	8	A	4124-23	23	A	4124-38	38	A	4124-60	60	B
4124-9	9	A	4124-24	24	A	4124-39	39	A	4124-65	65	B
4124-10	10	A	4124-25	25	A	4124-40	40	A	4124-70	70	B
4124-11	11	A	4124-26	26	A	4124-41	41	A	4124-75	75	B
4124-12	12	A	4124-27	27	A	4124-42	42	A	4124-80	80	B
4124-13	13	A	4124-28	28	A	4124-43	43	A	4124-85	85	B
4124-14	14	A	4124-29	29	A	4124-44	44	A	4124-90	90	B
4124-15	15	A	4124-30	30	A	4124-45	45	A	4124-95	95	B
4124-16	16	A	4124-31	31	A	4124-46	46	A	4124-100	100	B



ATTENTION:
BASIC MODEL

METRIC THREAD PLUG GAGES

- Supplied with Go and No-Go end
- Class 6H
- Standard ISO1502



4130-10

Individual

Code	Size (mm)	Code	Size (mm)	Code	Size (mm)	Code	Size (mm)	Code	Size (mm)	Code	Size (mm)
4130-2*	M2x0.4	4130-7*	M7x1	4130-18*	M18x2.5	4130-39*	M39x4				
4130-2D2*	M2.2x0.45	4130-8*	M8x1.25	4130-20*	M20x2.5	4130-42*	M42x4.5				
4130-2D5*	M2.5x0.45	4130-9*	M9x1.25	4130-22*	M22x2.5	4130-45*	M45x4.5				
4130-3*	M3x0.5	4130-10*	M10x1.5	4130-24*	M24x3	4130-48*	M48x5				
4130-3D5*	M3.5x0.6	4130-11*	M11x1.5	4130-27*	M27x3	4130-52*	M52x5				
4130-4*	M4x0.7	4130-12*	M12x1.75	4130-30*	M30x3.5	4130-56*	M56x5.5				
4130-5*	M5x0.8	4130-14*	M14x2	4130-33*	M33x3.5	4130-60*	M60x5.5				
4130-6*	M6x1	4130-16*	M16x2	4130-36*	M36x4						

Set

Code	Thread plug gages included
4130-S7*	M3x0.5(4130-3), M4x0.7(4130-4), M5x0.8(4130-5), M6x1(4130-6), M8x1.25(4130-8), M10x1.5(4130-10), M12x1.75(4130-12)

* Supplied with manufacturer inspection certificate

METRIC FINE THREAD PLUG GAGES

ATTENTION:
BASIC MODEL

INSPECTION
CERTIFICATE

- Supplied with Go and No-Go end
- Class 6H
- Standard ISO1502



4139-20G

Code	Size (mm)	Code	Size (mm)	Code	Size (mm)	Code	Size (mm)	Code	Size (mm)
4139-2B *	M2x0.25	4139-11L *	M11x0.75	4139-20L *	M20x0.75	4139-33L *	M33x0.75	4139-45X *	M45x4
4139-2D2B *	M2.2x0.25	4139-11P *	M11x1	4139-20P *	M20x1	4139-33P *	M33x1	4139-48P *	M48x1
4139-2D5D *	M2.5x0.35	4139-12G *	M12x0.5	4139-20R *	M20x1.5	4139-33R *	M33x1.5	4139-48R *	M48x1.5
4139-3D *	M3x0.35	4139-12L *	M12x0.75	4139-20T *	M20x2	4139-33T *	M33x2	4139-48T *	M48x2
4139-3D5D *	M3.5x0.35	4139-12P *	M12x1	4139-22G *	M22x0.5	4139-33V *	M33x3	4139-48V *	M48x3
4139-4G *	M4x0.5	4139-12Q *	M12x1.25	4139-22L *	M22x0.75	4139-36P *	M36x1	4139-48X *	M48x4
4139-5G *	M5x0.5	4139-12R *	M12x1.5	4139-22P *	M22x1	4139-36R *	M36x1.5	4139-52P *	M52x1
4139-6G *	M6x0.5	4139-14G *	M14x0.5	4139-22R *	M22x1.5	4139-36T *	M36x2	4139-52R *	M52x1.5
4139-6L *	M6x0.75	4139-14L *	M14x0.75	4139-22T *	M22x2	4139-36V *	M36x3	4139-52T *	M52x2
4139-7G *	M7x0.5	4139-14P *	M14x1	4139-24L *	M24x0.75	4139-39P *	M39x1	4139-52V *	M52x3
4139-7L *	M7x0.75	4139-14Q *	M14x1.25	4139-24P *	M24x1	4139-39R *	M39x1.5	4139-52X *	M52x4
4139-8G *	M8x0.5	4139-14R *	M14x1.5	4139-24R *	M24x1.5	4139-39T *	M39x2	4139-56P *	M56x1
4139-8L *	M8x0.75	4139-16G *	M16x0.5	4139-24T *	M24x2	4139-39V *	M39x3	4139-56R *	M56x1.5
4139-8P *	M8x1	4139-16L *	M16x0.75	4139-27L *	M27x0.75	4139-42P *	M42x1	4139-56T *	M56x2
4139-9G *	M9x0.5	4139-16P *	M16x1	4139-27P *	M27x1	4139-42R *	M42x1.5	4139-56V *	M56x3
4139-9L *	M9x0.75	4139-16R *	M16x1.5	4139-27R *	M27x1.5	4139-42T *	M42x2	4139-56X *	M56x4
4139-9P *	M9x1	4139-18G *	M18x0.5	4139-27T *	M27x2	4139-42V *	M42x3	4139-60P *	M60x1
4139-10G *	M10x0.5	4139-18L *	M18x0.75	4139-30L *	M30x0.75	4139-42X *	M42x4	4139-60R *	M60x1.5
4139-10L *	M10x0.75	4139-18P *	M18x1	4139-30P *	M30x1	4139-45P *	M45x1	4139-60T *	M60x2
4139-10P *	M10x1	4139-18R *	M18x1.5	4139-30R *	M30x1.5	4139-45R *	M45x1.5	4139-60V *	M60x3
4139-10Q *	M10x1.25	4139-18T *	M18x2	4139-30T *	M30x2	4139-45T *	M45x2	4139-60X *	M60x4
4139-11G *	M11x0.5	4139-20G *	M20x0.5	4139-30V *	M30x3	4139-45V *	M45x3		

* Supplied with manufacturer inspection certificate

METRIC THREAD RING GAGES

INSPECTION
CERTIFICATE

- Go and No-Go gages are supplied separately
- Class 6g
- Standard ISO1502



4120-16



4120-16N

ATTENTION:
BASIC MODEL

Individual

Code (GO)	Code (NOGO)	Size (mm)	Code (GO)	Code (NOGO)	Size (mm)	Code (GO)	Code (NOGO)	Size (mm)
4120-2 *	4120-2N *	M2x0.4	4120-10 *	4120-10N *	M10x1.5	4120-33 *	4120-33N *	M33x3.5
4120-2D2 *	4120-2D2N *	M2.2x0.45	4120-11 *	4120-11N *	M11x1.5	4120-36 *	4120-36N *	M36x4
4120-2D5 *	4120-2D5N *	M2.5x0.45	4120-12 *	4120-12N *	M12x1.75	4120-39 *	4120-39N *	M39x4
4120-3 *	4120-3N *	M3x0.5	4120-14 *	4120-14N *	M14x2	4120-42 *	4120-42N *	M42x4.5
4120-3D5 *	4120-3D5N *	M3.5x0.6	4120-16 *	4120-16N *	M16x2	4120-45 *	4120-45N *	M45x4.5
4120-4 *	4120-4N *	M4x0.7	4120-18 *	4120-18N *	M18x2.5	4120-48 *	4120-48N *	M48x5
4120-5 *	4120-5N *	M5x0.8	4120-20 *	4120-20N *	M20x2.5	4120-52 *	4120-52N *	M52x5
4120-6 *	4120-6N *	M6x1	4120-22 *	4120-22N *	M22x2.5	4120-56 *	4120-56N *	M56x5.5
4120-7 *	4120-7N *	M7x1	4120-24 *	4120-24N *	M24x3	4120-60 *	4120-60N *	M60x5.5
4120-8 *	4120-8N *	M8x1.25	4120-27 *	4120-27N *	M27x3			
4120-9 *	4120-9N *	M9x1.25	4120-30 *	4120-30N *	M30x3.5			

Go ring gage set

Code	Thread ring gages included
4120-S7 *	M3x0.5(4120-3), M4x0.7(4120-4), M5x0.8(4120-5), M6x1(4120-6), M8x1.25(4120-8), M10x1.5(4120-10), M12x1.75(4120-12)

No Go ring gage set

Code	Thread ring gages included
4120-S7N *	M3x0.5(4120-3N), M4x0.7(4120-4N), M5x0.8(4120-5N), M6x1(4120-6N), M8x1.25(4120-8N), M10x1.5(4120-10N), M12x1.75(4120-12N)

* Supplied with manufacturer inspection certificate

METRIC FINE THREAD RING GAGES

- Go and No-Go gages are supplied separately
- Class 6g
- Standard ISO1502



4129-10P



4129-10PN

Code (GO)	Code (NOGO)	Size (mm)	Code (GO)	Code (NOGO)	Size (mm)	Code (GO)	Code (NOGO)	Size (mm)
4129-2B*	4129-2BN*	M2x0.25	4129-16R*	4129-16RN*	M16x1.5	4129-36V*	4129-36VN*	M36x3
4129-2D2B*	4129-2D2BN*	M2.2x0.25	4129-18G*	4129-18GN*	M18x0.5	4129-39P*	4129-39PN*	M39x1
4129-2D5D*	4129-2D5DN*	M2.5x0.35	4129-18L*	4129-18LN*	M18x0.75	4129-39R*	4129-39RN*	M39x1.5
4129-3D*	4129-3DN*	M3x0.35	4129-18P*	4129-18PN*	M18x1	4129-39T*	4129-39TN*	M39x2
4129-3D5D*	4129-3D5DN*	M3.5x0.35	4129-18R*	4129-18RN*	M18x1.5	4129-39V*	4129-39VN*	M39x3
4129-4G*	4129-4GN*	M4x0.5	4129-18T*	4129-18TN*	M18x2	4129-42P*	4129-42PN*	M42x1
4129-5G*	4129-5GN*	M5x0.5	4129-20G*	4129-20GN*	M20x0.5	4129-42R*	4129-42RN*	M42x1.5
4129-6G*	4129-6GN*	M6x0.5	4129-20L*	4129-20LN*	M20x0.75	4129-42T*	4129-42TN*	M42x2
4129-6L*	4129-6LN*	M6x0.75	4129-20P*	4129-20PN*	M20x1	4129-42V*	4129-42VN*	M42x3
4129-7G*	4129-7GN*	M7x0.5	4129-20R*	4129-20RN*	M20x1.5	4129-42X*	4129-42XN*	M42x4
4129-7L*	4129-7LN*	M7x0.75	4129-20T*	4129-20TN*	M20x2	4129-45P*	4129-45PN*	M45x1
4129-8G*	4129-8GN*	M8x0.5	4129-22G*	4129-22GN*	M22x0.5	4129-45R*	4129-45RN*	M45x1.5
4129-8L*	4129-8LN*	M8x0.75	4129-22L*	4129-22LN*	M22x0.75	4129-45T*	4129-45TN*	M45x2
4129-8P*	4129-8PN*	M8x1	4129-22P*	4129-22PN*	M22x1	4129-45V*	4129-45VN*	M45x3
4129-9G*	4129-9GN*	M9x0.5	4129-22R*	4129-22RN*	M22x1.5	4129-45X*	4129-45XN*	M45x4
4129-9L*	4129-9LN*	M9x0.75	4129-22T*	4129-22TN*	M22x2	4129-48P*	4129-48PN*	M48x1
4129-9P*	4129-9PN*	M9x1	4129-24L*	4129-24LN*	M24x0.75	4129-48R*	4129-48RN*	M48x1.5
4129-10G*	4129-10GN*	M10x0.5	4129-24P*	4129-24PN*	M24x1	4129-48T*	4129-48TN*	M48x2
4129-10L*	4129-10LN*	M10x0.75	4129-24R*	4129-24RN*	M24x1.5	4129-48V*	4129-48VN*	M48x3
4129-10P*	4129-10PN*	M10x1	4129-24T*	4129-24TN*	M24x2	4129-48X*	4129-48XN*	M48x4
4129-10Q*	4129-10QN*	M10x1.25	4129-27L*	4129-27LN*	M27x0.75	4129-52P*	4129-52PN*	M52x1
4129-11G*	4129-11GN*	M11x0.5	4129-27P*	4129-27PN*	M27x1	4129-52R*	4129-52RN*	M52x1.5
4129-11L*	4129-11LN*	M11x0.75	4129-27R*	4129-27RN*	M27x1.5	4129-52T*	4129-52TN*	M52x2
4129-11P*	4129-11PN*	M11x1	4129-27T*	4129-27TN*	M27x2	4129-52V*	4129-52VN*	M52x3
4129-12G*	4129-12GN*	M12x0.5	4129-30L*	4129-30LN*	M30x0.75	4129-52X*	4129-52XN*	M52x4
4129-12L*	4129-12LN*	M12x0.75	4129-30P*	4129-30PN*	M30x1	4129-56P*	4129-56PN*	M56x1
4129-12P*	4129-12PN*	M12x1	4129-30R*	4129-30RN*	M30x1.5	4129-56R*	4129-56RN*	M56x1.5
4129-12Q*	4129-12QN*	M12x1.25	4129-30T*	4129-30TN*	M30x2	4129-56T*	4129-56TN*	M56x2
4129-12R*	4129-12RN*	M12x1.5	4129-30V*	4129-30VN*	M30x3	4129-56V*	4129-56VN*	M56x3
4129-14G*	4129-14GN*	M14x0.5	4129-33L*	4129-33LN*	M33x0.75	4129-56X*	4129-56XN*	M56x4
4129-14L*	4129-14LN*	M14x0.75	4129-33P*	4129-33PN*	M33x1	4129-60P*	4129-60PN*	M60x1
4129-14P*	4129-14PN*	M14x1	4129-33R*	4129-33RN*	M33x1.5	4129-60R*	4129-60RN*	M60x1.5
4129-14Q*	4129-14QN*	M14x1.25	4129-33T*	4129-33TN*	M33x2	4129-60T*	4129-60TN*	M60x2
4129-14R*	4129-14RN*	M14x1.5	4129-33V*	4129-33VN*	M33x3	4129-60V*	4129-60VN*	M60x3
4129-16G*	4129-16GN*	M16x0.5	4129-36P*	4129-36PN*	M36x1	4129-60X*	4129-60XN*	M60x4
4129-16L*	4129-16LN*	M16x0.75	4129-36R*	4129-36RN*	M36x1.5			
4129-16P*	4129-16PN*	M16x1	4129-36T*	4129-36TN*	M36x2			

* Supplied with manufacturer inspection certificate

Code	Size	Code	Size
4131-41*	4-40UNC	4131-3C2*	3/8-24UNF
4131-61*	6-32UNC	4131-7D2*	7/16-20UNF
4131-81*	8-32UNC	4131-1A1*	1/2-13UNC
4131-102*	10-32UNF	4131-1A2*	1/2-20UNF
4131-1B1*	1/4-20UNC	4131-9D2*	9/16-18UNF
4131-1B2*	1/4-28UNF	4131-5C1*	5/8-11UNC
4131-5D1*	5/16-18UNC	4131-5C2*	5/8-18UNF
4131-5D2*	5/16-24UNF	4131-3B1*	3/4-10UNC
4131-3C1*	3/8-16UNC	4131-3B2*	3/4-16UNF

* Supplied with manufacturer inspection certificate

AMERICAN STANDARD THREAD PLUG GAGES

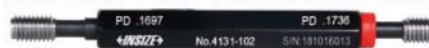

4131-102

- Supplied with Go and No-Go end
- Class 2B
- Standard ANSI B1.2

AMERICAN STANDARD THREAD RING GAGES

INSIZE
CERTIFICATE

ATTENTION:
BASIC MODEL

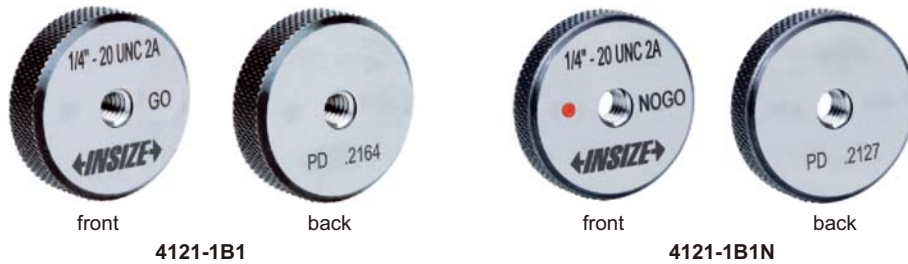

- Class 2A
- Standard ANSI B1.2

Code (GO)	Code (NOGO)	Size	Code (GO)	Code (NOGO)	Size	Code (GO)	Code (NOGO)	Size
4121-41 *	4121-41N *	4-40UNC	4121-5D1 *	4121-5D1N *	5/16-18UNC	4121-1A2 *	4121-1A2N *	1/2-20UNF
4121-61 *	4121-61N *	6-32UNC	4121-5D2 *	4121-5D2N *	5/16-24UNF	4121-9D2 *	4121-9D2N *	9/16-18UNF
4121-81 *	4121-81N *	8-32UNC	4121-3C1 *	4121-3C1N *	3/8-16UNC	4121-5C1 *	4121-5C1N *	5/8-11UNC
4121-102 *	4121-102N *	10-32UNF	4121-3C2 *	4121-3C2N *	3/8-24UNF	4121-5C2 *	4121-5C2N *	5/8-18UNF
4121-1B1 *	4121-1B1N *	1/4-20UNC	4121-7D2 *	4121-7D2N *	7/16-20UNF	4121-3B1 *	4121-3B1N *	3/4-10UNC
4121-1B2 *	4121-1B2N *	1/4-28UNF	4121-1A1 *	4121-1A1N *	1/2-13UNC	4121-3B2 *	4121-3B2N *	3/4-16UNF

* Supplied with manufacturer inspection certificate

METRIC THREAD PLUG GAGES

INSIZE
CERTIFICATE



- Supplied with Go and No-Go end
- Class 6H
- Standard ISO1502
- Material: OHNS
(Oil Hardened Non-shrinking Steel),
stable dimension and wear resistance
- Hardness HRC60-62



4641-6

CLASS 5H OF M1.0, M1.1,
M1.2, M1.4 ARE AVAILABLE

Code	Size (mm)	Code	Size (mm)	Code	Size (mm)	Code	Size (mm)	Code	Size (mm)
4641-1D6 *	M1.6x0.35	4641-4 *	M4x0.7	4641-12 *	M12x1.75	4641-22 *	M22x2.5	4641-36 *	M36x4
4641-2 *	M2x0.4	4641-5 *	M5x0.8	4641-14 *	M14x2	4641-24 *	M24x3	4641-42 *	M42x4.5
4641-2D5 *	M2.5x0.45	4641-6 *	M6x1	4641-16 *	M16x2	4641-27 *	M27x3	4641-48 *	M48x5
4641-3 *	M3x0.5	4641-8 *	M8x1.25	4641-18 *	M18x2.5	4641-30 *	M30x3.5		
4641-3D5 *	M3.5x0.6	4641-10 *	M10x1.5	4641-20 *	M20x2.5	4641-33 *	M33x3.5		

* Supplied with manufacturer inspection certificate

METRIC FINE THREAD PLUG GAGES

INSIZE
CERTIFICATE



- Supplied with Go and No-Go end
- Class 6H
- Standard ISO1502
- Material: OHNS
(Oil Hardened Non-shrinking Steel),
stable dimension and wear resistance
- Hardness HRC60-62



4642-12R

Code	Size (mm)	Code	Size (mm)	Code	Size (mm)	Code	Size (mm)	Code	Size (mm)
4642-8G *	M8x0.5	4642-14R *	M14x1.5	4642-25R *	M25x1.5	4642-35R *	M35x1.5	4642-48T *	M48x2
4642-8L *	M8x0.75	4642-16P *	M16x1	4642-26R *	M26x1.5	4642-36R *	M36x1.5	4642-50R *	M50x1.5
4642-8P *	M8x1	4642-16R *	M16x1.5	4642-27R *	M27x1.5	4642-36T *	M36x2	4642-50T *	M50x2
4642-10L *	M10x0.75	4642-18P *	M18x1	4642-27T *	M27x2	4642-38R *	M38x1.5	4642-52R *	M52x1.5
4642-10P *	M10x1	4642-18R *	M18x1.5	4642-28R *	M28x1.5	4642-40R *	M40x1.5	4642-52T *	M52x2
4642-10Q *	M10x1.25	4642-20P *	M20x1	4642-30P *	M30x1	4642-40T *	M40x2	4642-55R *	M55x1.5
4642-12P *	M12x1	4642-20R *	M20x1.5	4642-30R *	M30x1.5	4642-42R *	M42x1.5	4642-55T *	M55x2
4642-12Q *	M12x1.25	4642-22R *	M22x1.5	4642-30T *	M30x2	4642-42T *	M42x2	4642-58R *	M58x1.5
4642-12R *	M12x1.5	4642-24P *	M24x1	4642-32R *	M32x1.5	4642-45R *	M45x1.5	4642-60T *	M60x2
4642-14P *	M14x1	4642-24R *	M24x1.5	4642-33R *	M33x1.5	4642-45T *	M45x2		
4642-14Q *	M14x1.25	4642-24T *	M24x2	4642-33T *	M33x2	4642-48R *	M48x1.5		

* Supplied with manufacturer inspection certificate



METRIC THREAD RING GAGES

CLASS 6h OF M1.2, M1.4
ARE AVAILABLE



4631-12



4631-12N

- Class 6g
- Standard ISO1502
- Material: OHNS
(Oil Hardened Non-shrinking Steel),
stable dimension and wear resistance
- Hardness HRC60-62

Code (GO)	Code (NOGO)	Size(mm)
4631-1D6 *	4631-1D6N *	M1.6x0.35
4631-2 *	4631-2N *	M2x0.4
4631-2D5 *	4631-2D5N *	M2.5x0.45
4631-3 *	4631-3N *	M3x0.5
4631-3D5 *	4631-3D5N *	M3.5x0.6
4631-4 *	4631-4N *	M4x0.7
4631-5 *	4631-5N *	M5x0.8
4631-6 *	4631-6N *	M6x1

Code (GO)	Code (NOGO)	Size (mm)
4631-8 *	4631-8N *	M8x1.25
4631-10 *	4631-10N *	M10x1.5
4631-12 *	4631-12N *	M12x1.75
4631-14 *	4631-14N *	M14x2
4631-16 *	4631-16N *	M16x2
4631-18 *	4631-18N *	M18x2.5
4631-20 *	4631-20N *	M20x2.5
4631-22 *	4631-22N *	M22x2.5

Code (GO)	Code (NOGO)	Size (mm)
4631-24 *	4631-24N *	M24x3
4631-27 *	4631-27N *	M27x3
4631-30 *	4631-30N *	M30x3.5
4631-33 *	4631-33N *	M33x3.5
4631-36 *	4631-36N *	M36x4
4631-42 *	4631-42N *	M42x4.5
4631-48 *	4631-48N *	M48x5

* Supplied with manufacturer inspection certificate



METRIC FINE THREAD RING GAGES

- Class 6g
- Standard ISO1502
- Material: OHNS (Oil Hardened Non-shrinking Steel),
stable dimension and wear resistance
- Hardness HRC60-62



4632-10Q



4632-10QN

Code (GO)	Code (NOGO)	Size (mm)
4632-8G *	4632-8GN *	M8x0.5
4632-8L *	4632-8LN *	M8x0.75
4632-8P *	4632-8PN *	M8x1
4632-10L *	4632-10LN *	M10x0.75
4632-10P *	4632-10PN *	M10x1
4632-10Q *	4632-10QN *	M10x1.25
4632-12P *	4632-12PN *	M12x1
4632-12Q *	4632-12QN *	M12x1.25
4632-12R *	4632-12RN *	M12x1.5
4632-14P *	4632-14PN *	M14x1
4632-14Q *	4632-14QN *	M14x1.25
4632-14R *	4632-14RN *	M14x1.5
4632-16P *	4632-16PN *	M16x1
4632-16R *	4632-16RN *	M16x1.5
4632-18P *	4632-18PN *	M18x1
4632-18R *	4632-18RN *	M18x1.5
4632-20P *	4632-20PN *	M20x1
4632-20R *	4632-20RN *	M20x1.5

Code (GO)	Code (NOGO)	Size (mm)
4632-22R *	4632-22RN *	M22x1.5
4632-24P *	4632-24PN *	M24x1
4632-24R *	4632-24RN *	M24x1.5
4632-24T *	4632-24TN *	M24x2
4632-25R *	4632-25RN *	M25x1.5
4632-26R *	4632-26RN *	M26x1.5
4632-27R *	4632-27RN *	M27x1.5
4632-27T *	4632-27TN *	M27x2
4632-28R *	4632-28RN *	M28x1.5
4632-30P *	4632-30PN *	M30x1
4632-30R *	4632-30RN *	M30x1.5
4632-30T *	4632-30TN *	M30x2
4632-32R *	4632-32RN *	M32x1.5
4632-33R *	4632-33RN *	M33x1.5
4632-33T *	4632-33TN *	M33x2
4632-35R *	4632-35RN *	M35x1.5
4632-36R *	4632-36RN *	M36x1.5
4632-36T *	4632-36TN *	M36x2

Code (GO)	Code (NOGO)	Size (mm)
4632-38R *	4632-38RN *	M38x1.5
4632-40R *	4632-40RN *	M40x1.5
4632-40T *	4632-40TN *	M40x2
4632-42R *	4632-42RN *	M42x1.5
4632-42T *	4632-42TN *	M42x2
4632-45R *	4632-45RN *	M45x1.5
4632-45T *	4632-45TN *	M45x2
4632-48R *	4632-48RN *	M48x1.5
4632-48T *	4632-48TN *	M48x2
4632-50R *	4632-50RN *	M50x1.5
4632-50T *	4632-50TN *	M50x2
4632-52R *	4632-52RN *	M52x1.5
4632-52T *	4632-52TN *	M52x2
4632-55R *	4632-55RN *	M55x1.5
4632-55T *	4632-55TN *	M55x2
4632-58R *	4632-58RN *	M58x1.5
4632-60T *	4632-60TN *	M60x2

* Supplied with manufacturer inspection certificate

AMERICAN STANDARD THREAD PLUG GAGES



4643-102

- Supplied with Go and No-Go end
- Class 2B
- Standard ANSI B1.2
- Material: OHNS (Oil Hardened Non-shrinking Steel), stable dimension and wear resistance
- Hardness HRC60-62

Code	Size	Code	Size	Code	Size
4643-41*	4-40UNC	4643-5D1*	5/16-18UNC	4643-1A2*	1/2-20UNF
4643-61*	6-32UNC	4643-5D2*	5/16-24UNF	4643-9D2*	9/16-18UNF
4643-81*	8-32UNC	4643-3C1*	3/8-16UNC	4643-5C1*	5/8-11UNC
4643-102*	10-32UNF	4643-3C2*	3/8-24UNF	4643-5C2*	5/8-18UNF
4643-1B1*	1/4-20UNC	4643-7D2*	7/16-20UNF	4643-3B1*	3/4-10UNC
4643-1B2*	1/4-28UNF	4643-1A1*	1/2-13UNC	4643-3B2*	3/4-16UNF

* Supplied with manufacturer inspection certificate

AMERICAN STANDARD THREAD RING GAGES

- Class 2A
- Standard ANSI B1.2
- Material: OHNS (Oil Hardened Non-shrinking Steel), stable dimension and wear resistance
- Hardness HRC60-62

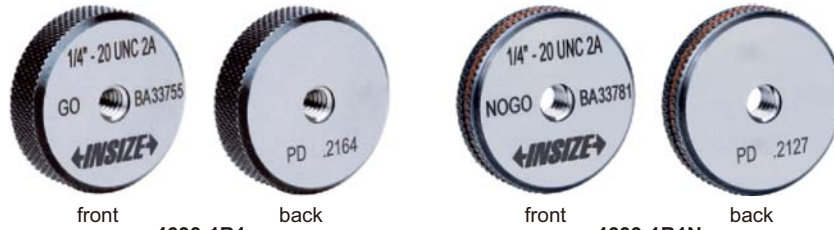

Code (GO)	Code (NOGO)	Size	Code (GO)	Code (NOGO)	Size	Code (GO)	Code (NOGO)	Size
4633-41*	4633-41N*	4-40UNC	4633-5D1*	4633-5D1N*	5/16-18UNC	4633-1A2*	4633-1A2N*	1/2-20UNF
4633-61*	4633-61N*	6-32UNC	4633-5D2*	4633-5D2N*	5/16-24UNF	4633-9D2*	4633-9D2N*	9/16-18UNF
4633-81*	4633-81N*	8-32UNC	4633-3C1*	4633-3C1N*	3/8-16UNC	4633-5C1*	4633-5C1N*	5/8-11UNC
4633-102*	4633-102N*	10-32UNF	4633-3C2*	4633-3C2N*	3/8-24UNF	4633-5C2*	4633-5C2N*	5/8-18UNF
4633-1B1*	4633-1B1N*	1/4-20UNC	4633-7D2*	4633-7D2N*	7/16-20UNF	4633-3B1*	4633-3B1N*	3/4-10UNC
4633-1B2*	4633-1B2N*	1/4-28UNF	4633-1A1*	4633-1A1N*	1/2-13UNC	4633-3B2*	4633-3B2N*	3/4-16UNF

* Supplied with manufacturer inspection certificate

NPT THREAD PLUG GAGES



4644-1B18

- American tapered pipe thread for threads with sealant
- Standard ANSI / ASME B1.20.1
- Taper 1:16
- Material: OHNS (Oil Hardened Non-shrinking Steel), stable dimension and wear resistance
- Hardness HRC60-62

Code	Size	Code	Size	Code	Size
4644-1D27*	1/16x27NPT	4644-3B14*	3/4x14NPT	4644-1J8*	2-1/2x8NPT
4644-1C27*	1/8x27NPT	4644-112*	1x11.5NPT	4644-38*	3x8NPT
4644-1B18*	1/4x18NPT	4644-1G12*	1-1/4x11.5NPT	4644-1N8*	3-1/2x8NPT
4644-3C18*	3/8x18NPT	4644-1H12*	1-1/2x11.5NPT	4644-48*	4x8NPT
4644-1A14*	1/2x14NPT	4644-212*	2x11.5NPT		

* Supplied with manufacturer inspection certificate

NPT THREAD RING GAGES



- American tapered pipe thread for threads with sealant
- Standard ANSI / ASME B1.20.1
- Taper 1:16
- Material: OHNS (Oil Hardened Non-shrinking Steel), stable dimension and wear resistance
- Hardness HRC60-62

Code	Size	Code	Size
4634-1D27*	1/16x27NPT	4634-1G12*	1-1/4x11.5NPT
4634-1C27*	1/8x27NPT	4634-1H12*	1-1/2x11.5NPT
4634-1B18*	1/4x18NPT	4634-212*	2x11.5NPT
4634-3C18*	3/8x18NPT	4634-1J8*	2-1/2x8NPT
4634-1A14*	1/2x14NPT	4634-38*	3x8NPT
4634-3B14*	3/4x14NPT	4634-1N8*	3-1/2x8NPT
4634-112*	1x11.5NPT	4634-48*	4x8NPT

* Supplied with manufacturer inspection certificate



INSIZE
CERTIFICATE

WHITWORTH PIPE THREAD PLUG GAGES (G SERIES)

Code	Size	Code	Size
4645-1C28 *	G 1/8-28	4645-111 *	G 1-11
4645-1B19 *	G 1/4-19	4645-1G11 *	G 1.1/4-11
4645-3C19 *	G 3/8-19	4645-1H11 *	G 1.1/2-11
4645-1A14 *	G 1/2-14	4645-211 *	G 2-11
4645-3B14 *	G 3/4-14		

* Supplied with manufacturer inspection certificate



4645-1A14

- Supplied with Go and No-Go end
- Standard ISO 228



INSIZE
CERTIFICATE

WHITWORTH PIPE THREAD RING GAGES (G SERIES)

Code (GO)	Code (NOGO)	Size	Code (GO)	Code (NOGO)	Size
4635-1C28 *	4635-1C28N *	G 1/8-28	4635-111 *	4635-111N *	G 1-11
4635-1B19 *	4635-1B19N *	G 1/4-19	4635-1G11 *	4635-1G11N *	G 1.1/4-11
4635-3C19 *	4635-3C19N *	G 3/8-19	4635-1H11 *	4635-1H11N *	G 1.1/2-11
4635-1A14 *	4635-1A14N *	G 1/2-14	4635-211 *	4635-211N *	G 2-11
4635-3B14 *	4635-3B14N *	G 3/4-14			

* Supplied with manufacturer inspection certificate



4635-1A14



4635-1A14N

- Class A
- Standard ISO 228



INSIZE
CERTIFICATE

BSPT TAPER THREAD PLUG GAGES

Code	Size	Code	Size
4646-1C28 *	1/8-28 BSPT	4646-1H11 *	1.1/2-11 BSPT
4646-1B19 *	1/4-19 BSPT	4646-211 *	2-11 BSPT
4646-3C19 *	3/8-19 BSPT	4646-2H11 *	2.1/2-11 BSPT
4646-1A14 *	1/2-14 BSPT	4646-311 *	3-11 BSPT
4646-3B14 *	3/4-14 BSPT	4646-411 *	4-11 BSPT
4646-111 *	1-11 BSPT	4646-511 *	5-11 BSPT
4646-1G11 *	1.1/4-11 BSPT	4646-611 *	6-11 BSPT

* Supplied with manufacturer inspection certificate



4646-1A14

- Standard BS 21-1985



INSIZE
CERTIFICATE

BSPT TAPER THREAD RING GAGES

Code	Size	Code	Size
4636-1C28 *	1/8-28 BSPT	4636-1H11 *	1.1/2-11 BSPT
4636-1B19 *	1/4-19 BSPT	4636-211 *	2-11 BSPT
4636-3C19 *	3/8-19 BSPT	4636-2H11 *	2.1/2-11 BSPT
4636-1A14 *	1/2-14 BSPT	4636-311 *	3-11 BSPT
4636-3B14 *	3/4-14 BSPT	4636-411 *	4-11 BSPT
4636-111 *	1-11 BSPT	4636-511 *	5-11 BSPT
4636-1G11 *	1.1/4-11 BSPT	4636-611 *	6-11 BSPT

* Supplied with manufacturer inspection certificate



front



back

4636-1A14

- Standard BS 21-1985

WATERPROOF DIGITAL PROTRACTOR (HEAVY DUTY)

IP54
WATERPROOF

ABSOLUTE
LEVEL

AUTOMATIC
BACKLIGHT

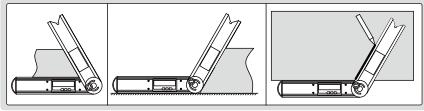

- Suitable for setting horizontal and vertical mitre angles of cutting machine
- Buttons: ON/OFF, HOLD/SUP, SPR/CNR/MTR/BVL
- IP54 dust/waterproof
- With transverse and longitudinal vials
- 2xAAA batteries
- Absolute level, zero setting is not needed when batteries are replaced
- Backlight will turn off in one minute after no data changing, automatic power off in 5 minutes



2174-225

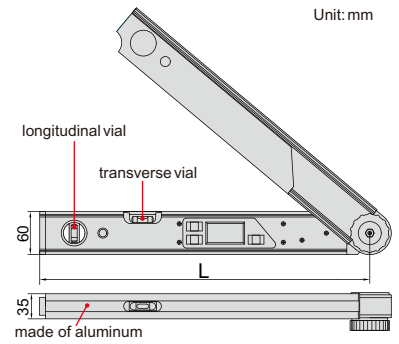

Code	Size (L)	Range	Resolution	Accuracy
2174-225	460mm	0-225°	0.05°	±0.10°

DIGITAL PROTRACTOR



2171-250

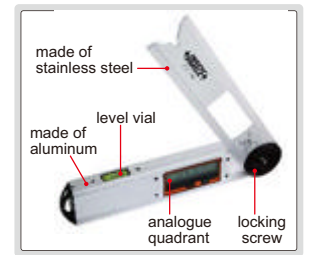
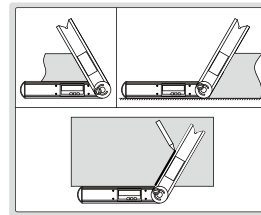
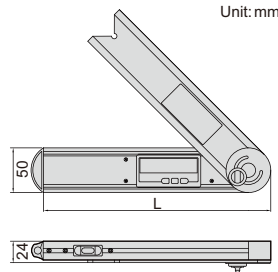

- Buttons: on/off, hold (keep the reading), zero, ABS (absolute and incremental measurement)
- Fix the locking screw at 4 positions for different measuring ranges: 0°~225°, -225°~0°, -45°~180°, -180°~45°
- Remove the locking screw for 360° range
- With level vial
- Battery CR2032
- Automatic power off

Code	Size (L)	Range	Resolution	Accuracy
2171-250	250mm	0-360°	0.05°	±0.15°

DIGITAL PROTRACTORS

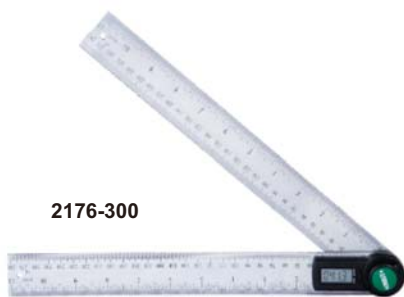

2176-300

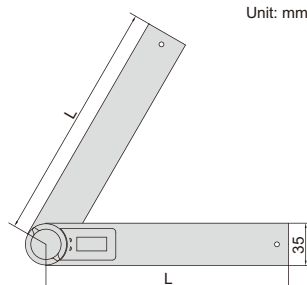

- Buttons: on/off, zero
- With clamping screw to lock the blades
- Graduation of blade: 1mm and 1/32"
- Made of stainless steel
- CR2032 battery
- Automatic power off

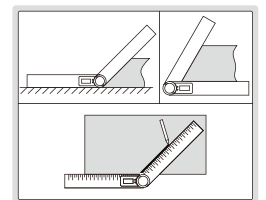

Code	Size(L)	Range	Resolution	Accuracy
2176-200	200mm	0-360°	0.1°	±0.3°
2176-300	300mm	0-360°	0.1°	±0.3°

PROTRACTOR

- Made of stainless steel
- Satin chrome plated scale
- With clamping screw



4780-85

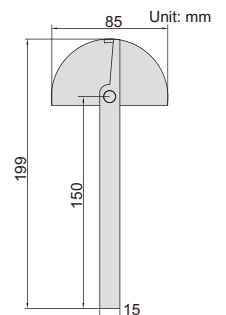

Code	Size	Range	Graduation	Accuracy
4780-85	85x150mm	0-180°	1°	±0.3°

PROTRACTOR

4 working edges

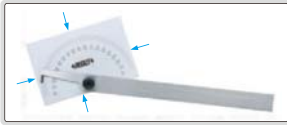

- Made of stainless steel
- Satin chrome plated scale
- With clamping screw

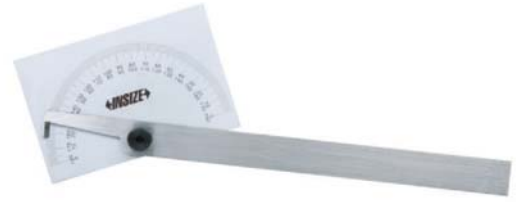
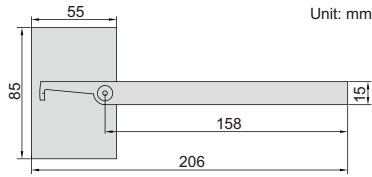

4781-85

Code	Size	Range	Graduation	Accuracy
4781-85	85x158mm	0-180°	1°	±0.3°

PROTRACTORS

- Graduation: 1°
- Made of stainless steel (4799-1300 is made of carbon steel)
- Satin chrome plated scale
- With clamping screw

Code	Size (AxB)	Range	Accuracy	L	C
4799-180	80x120mm	0-180°	±0.3°	168	11
4799-1120	120x150mm	0-180°	±0.3°	220	14
4799-1150	150x200mm	0-180°	±0.3°	285	16
4799-1200	200x300mm	0-180°	±0.3°	413	20
4799-1300	300x500mm	0-180°	±0.3°	675	30

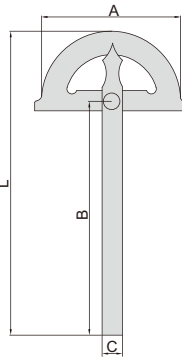

4799-180

PROTRACTORS

- Graduation: 1°
- Made of carbon steel
- Satin chrome plated
- With clamping screw
- The blade is moveable

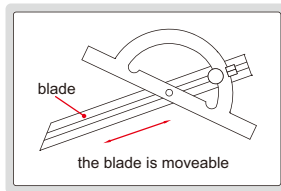

Code	Size (AxB)	Range	Accuracy	C
4797-100	100x150mm	10-170°	±0.3°	18
4797-150	150x300mm	10-170°	±0.3°	22
4797-200	200x400mm	10-170°	±0.3°	24
4797-250	250x500mm	10-170°	±0.3°	28
4797-300	300x600mm	10-170°	±0.3°	32

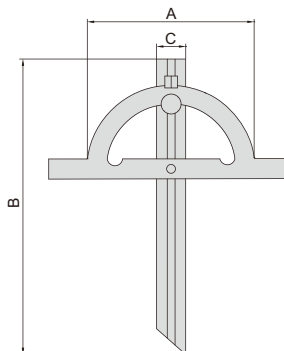

4797-100

PROTRACTOR

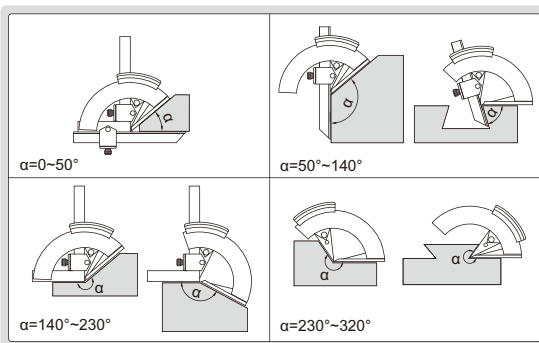

Code	Range	Graduation	Accuracy
2374-320	0-320°	2'	±2'

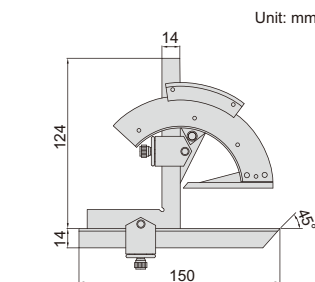

- Made of stainless steel
- Satin chrome plated scale



2374-320

UNIVERSAL PROTRACTOR

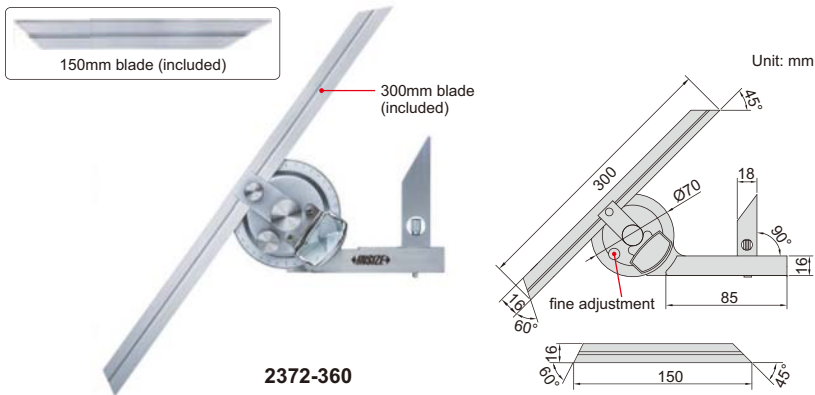

2372-360

clamp for height gages (optional)

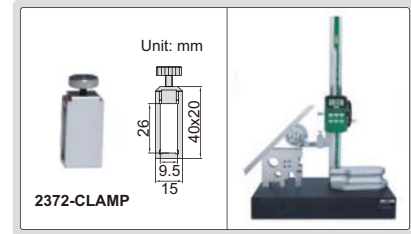

- Parallax-free reading
- Made of stainless steel
- Optional accessory: clamp (code 2372-CLAMP), suitable for height gages 1156, 1351 and 1250

Code	Range	Graduation	Accuracy
2372-360	0-360°	5'	±5'

DIAL PROTRACTOR

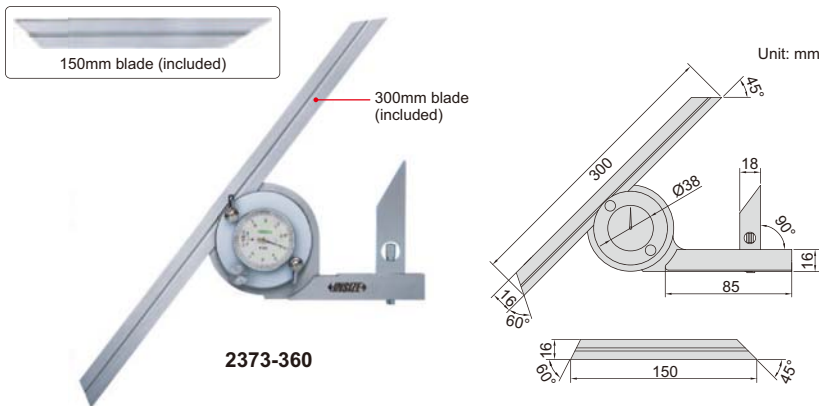

2373-360

clamp for height gages (optional)

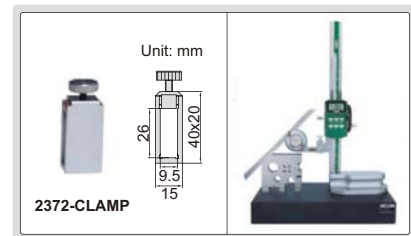

- Made of stainless steel
- Optional accessory: clamp (code 2372-CLAMP), suitable for height gages 1156, 1351 and 1250

Code	Range	Graduation	Accuracy
2373-360	0-360°	5'	±5'

DIGITAL PROTRACTOR

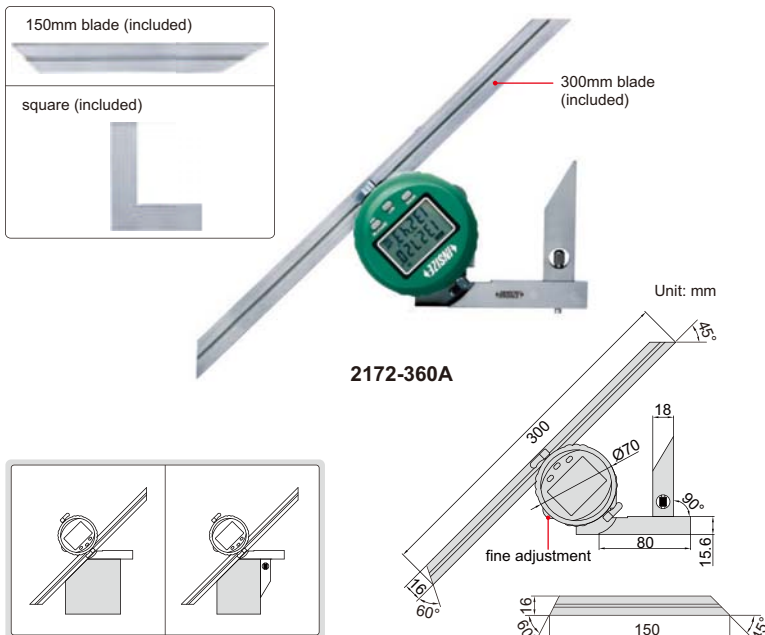

2172-360A

clamp for height gages (optional)

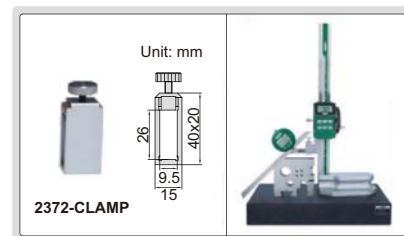

DATA
OUTPUT



VIDEO

- Display in degree (for example 32.655°) and degree/minute/second (for example 32°39'30")
- SET button: preset the reading, change measuring direction
- MODE button: choose 0~90°, 0~180° or 0~360° display
- ZERO/ON/OFF button: zero and power on/off
- Battery CR2032, automatic power off
- Data output
- Supplied with square to set 90°
- Made of stainless steel
- Optional accessory: data output cable (code 7305-SPC1A), clamp (code 2372-CLAMP), suitable for height gages 1156, 1351 and 1250

Code	Range	Resolution	Accuracy
2172-360A	0-360°	10"/0.005°	±5'

PERPENDICULARITY TESTERS

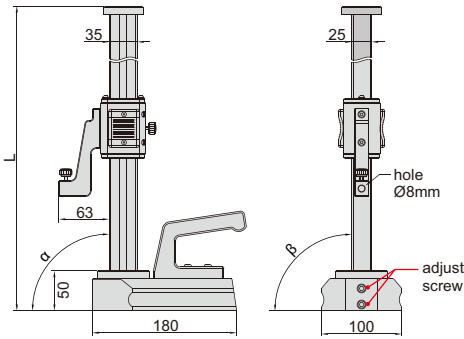
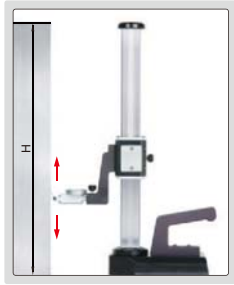

Unit: mm



4770-300

dial test indicator is not included

- Optional accessory: dial test indicators (graduation: 1µm or 2µm), cylinder square (code 4710, for calibration), granite square (code 4141, for calibration)

Code	Range (H)	Perpendicularity (α)	Side perpendicularity (β)	L
4770-300	0-300mm	3µm	10µm	460mm
4770-600	0-600mm	5µm	20µm	760mm

CYLINDER SQUARES



- Made of special alloy steel, hardness HRC58-60
- The handle can be removed

Code	Length (L)	Squareness
4710-200*	200mm	1µm
4710-300*	300mm	2µm

* Supplied with manufacturer inspection certificate



4710-200

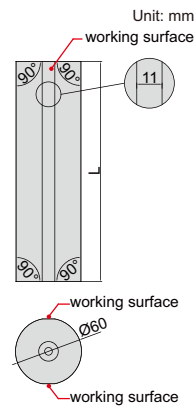

inspect 90° internal and external angles



GRANITE SQUARES

CUSTOM-MADE
SUPPLY SPECIAL SIZES ACCORDING
TO CUSTOMER'S REQUEST

Code	Size (HxW)	Flatness of A	Flatness of B	Squareness of A to B	D
4141-250	250x160mm	1µm	1µm	2µm	25mm
4141-400	400x250mm	1.5µm	1µm	3µm	40mm
4141-630	630x400mm	2µm	1.5µm	4µm	63mm

4141-250

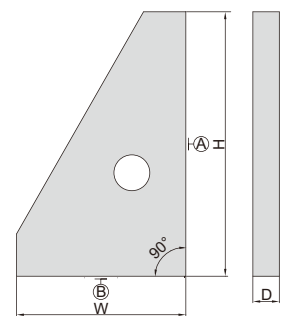

GRANITE SQUARE

CUSTOM-MADE
SUPPLY SPECIAL SIZES ACCORDING
TO CUSTOMER'S REQUEST

Code	Size (HxW)	Flatness of A, B, C and D	Squareness and parallelism between A, B, C and D
4144-315	315x315mm	1.1µm	2.6µm



4144-315

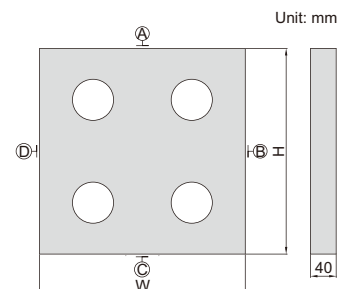

Unit: mm

GRANITE SQUARE WITH V GROOVE

- Parallelism and squareness of A, B, C, D, E and F: 6µm
- Parallelism and squareness of V groove to A, B, C, D, E and F: 6µm



4142-200

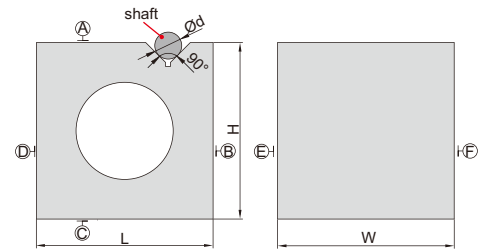

Code	Size (LxWxH)	Range of shaft (Ød)
4142-200	200x200x200mm	9~70mm

90° TOOL MAKER SQUARES

- DIN875 grade 00
- Beveled edge for inside measurement
- Made of hardened stainless steel

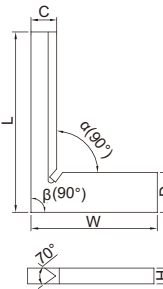

4794-040

Code	Size (LxW)	Squareness		C	D	H
		Inside (α)	Outside (β)			
4794-025	25x20mm	2.2µm	2.3µm	4	6.5	3.5
4794-040	40x28mm	2.3µm	2.4µm	5.5	8.5	3.5

(mm)

90° BEVELED EDGE SQUARES

- Satin chrome plating
- Beveled edges for inside and outside measurement
- Made of hardened stainless steel

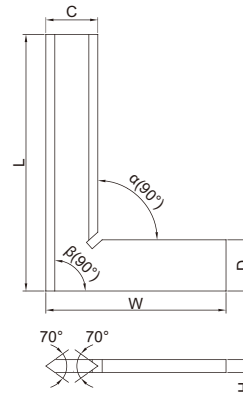

4790-0100

DIN875 grade 00 (mm)

Code	Size (LxW)	Squareness		C	D	H
		Inside (α)	Outside (β)			
4790-050	50x40mm	2.4µm	2.5µm	13	13	4
4790-075	75x50mm	2.6µm	2.8µm	15	15	4
4790-0100	100x70mm	2.8µm	3.0µm	20	20	5
4790-0150	150x100mm	3.2µm	3.5µm	30	30	6
4790-0200	200x130mm	3.7µm	4.0µm	34	34	7
4790-0250	250x165mm	4.2µm	4.5µm	35	35	7
4790-0300	300x200mm	4.6µm	5.0µm	40	40	8

DIN875 grade 0 (mm)

Code	Size (LxW)	Squareness		C	D	H
		Inside (α)	Outside (β)			
4790-500	50x40mm	6µm	6µm	13	13	4
4790-750	75x50mm	6µm	7µm	15	15	4
4790-1000	100x70mm	7µm	7µm	20	20	5
4790-1500	150x100mm	7µm	8µm	30	30	6
4790-2000	200x130mm	8µm	9µm	34	34	7
4790-2500	250x165mm	9µm	10µm	35	35	7
4790-3000	300x200mm	10µm	11µm	40	40	8

90° FLAT EDGE SQUARES

- DIN875 grade 0
- Made of hardened stainless steel

Code	Size (LxW)	Squareness		C	D	H	(mm)
		Inside (α)	Outside (β)				
4791-50	50x40mm	6 μ m	6 μ m	15	15	4	
4791-75	75x50mm	6 μ m	7 μ m	15	15	4	
4791-100	100x70mm	7 μ m	7 μ m	20	20	5	
4791-150	150x100mm	7 μ m	8 μ m	30	30	6	
4791-200	200x130mm	8 μ m	9 μ m	30	30	7	
4791-250	250x165mm	9 μ m	10 μ m	35	35	7	
4791-300	300x200mm	10 μ m	11 μ m	40	40	8	

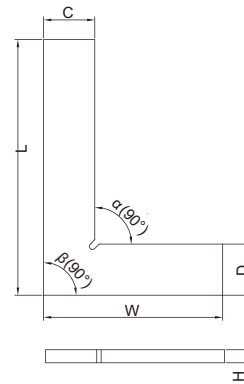

4791-100

90° FLAT EDGE SQUARES WITH WIDE BASE

- DIN875 grade 0
- Made of hardened stainless steel

Code	Size (LxW)	Squareness		C	D	H	E	(mm)
		Inside (α)	Outside (β)					
4793-50	50x40mm	6 μ m	6 μ m	13	13	4	13	
4793-75	75x50mm	6 μ m	7 μ m	15	15	4	15	
4793-100	100x70mm	7 μ m	7 μ m	20	20	5	20	
4793-150	150x100mm	7 μ m	8 μ m	30	30	6	30	
4793-200	200x130mm	8 μ m	9 μ m	30	30	7	30	
4793-250	250x165mm	9 μ m	10 μ m	35	35	7	35	
4793-300	300x200mm	10 μ m	11 μ m	40	40	8	40	

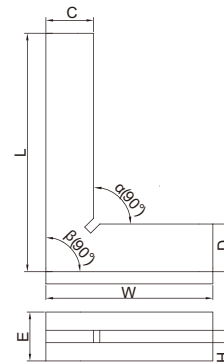

4793-100

90° FLAT EDGE SQUARES WITH WIDE BASE

- DIN875 grade 0
- Made of hardened stainless steel

Code	Size (LxW)	Squareness		C	D	H	E	(mm)
		Inside (α)	Outside (β)					
4792-50	50x40mm	6 μ m	6 μ m	12	12	3	10	
4792-75	75x50mm	6 μ m	7 μ m	14	14	3	10	
4792-100	100x70mm	7 μ m	7 μ m	18	18	3	10	
4792-150	150x100mm	8 μ m	8 μ m	22	22	4	12	
4792-200	200x130mm	9 μ m	9 μ m	25	25	4	12	

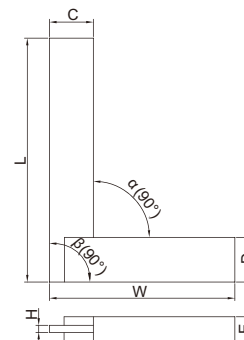

4792-100

90° BEVELED EDGE SQUARES WITH WIDE BASE

- DIN875 grade 0
- Beveled edges for inside and outside measurement
- Made of hardened stainless steel

Code	Size (LxW)	Squareness		C	D	H	E	(mm)
		Inside (α)	Outside (β)					
4795-50	50x40mm	6 μ m	6 μ m	12	12	3	10	
4795-75	75x50mm	6 μ m	7 μ m	14	14	3	10	
4795-100	100x70mm	7 μ m	7 μ m	18	18	3	10	
4795-150	150x100mm	8 μ m	8 μ m	22	22	4	12	
4795-200	200x130mm	9 μ m	9 μ m	25	25	4	12	

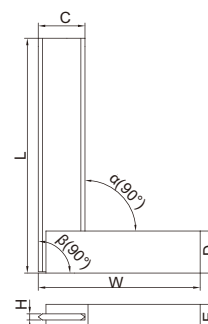

4795-100

MACHINIST SQUARES WITH WIDE BASE

ATTENTION:
LOW ACCURACY



4707-100

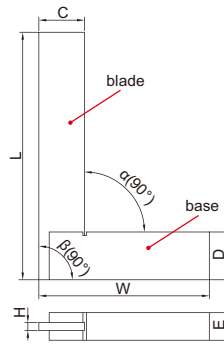

- Economic model
- DIN875 grade 2
- Made of carbon steel, no anti-rust treatment, not hardened

Code	Size (LxW)	Squareness		(mm)			
		Inside (α)	Outside (β)	C	D	H	E
4707-50	50x40mm	24 μ m	25 μ m	16	12	3	9
4707-75	75x50mm	26 μ m	28 μ m	16	16	3	9
4707-100	100x70mm	28 μ m	30 μ m	19	19	3	12
4707-150	150x100mm	33 μ m	35 μ m	25	25	3	16
4707-200	200x130mm	37 μ m	40 μ m	30	32	4	16
4707-250	250x165mm	42 μ m	45 μ m	30	32	4	19
4707-300	300x200mm	47 μ m	50 μ m	32	32	4	19
4707-400	400x250mm	56 μ m	60 μ m	38	38	5	22
4707-500	500x300mm	65 μ m	70 μ m	45	50	6	25
4707-600	600x350mm	75 μ m	80 μ m	50	50	6	30
4707-750	750x400mm	90 μ m	95 μ m	55	55	6	50
4707-900	900x500mm	103 μ m	110 μ m	65	75	9	50
4707-1000	1000x550mm	113 μ m	120 μ m	65	75	9	50

TRY SQUARE

- Graduation: 1mm
- Stainless steel blade, aluminum base



2275-300

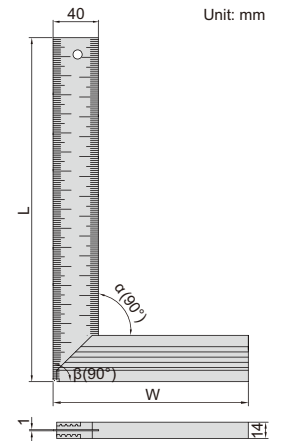

Code	Size (LxW)	Squareness	
		Inside (α)	Outside (β)
2275-300	300x170mm	0.5mm	0.5mm

ADJUSTABLE SQUARE

- The straight edge can move and can be locked by the clamping screw
- Made of hardened stainless steel

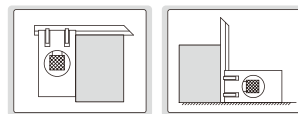

4701-1

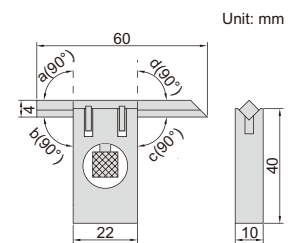

Code	Squareness (a, b, c, d)
4701-1	7 μ m

45° SQUARES

- Made of hardened stainless steel

Code	Size (LxW)	Accuracy		(mm)		
		Inside (α)	Outside (β)	C	D	H
4745-1100	100x70mm	27 μ m	30 μ m	20	20	5
4745-1120	120x80mm	29 μ m	32 μ m	20	20	5
4745-1150	150x100mm	32 μ m	35 μ m	20	20	5
4745-1200	200x130mm	36 μ m	40 μ m	25	25	5



4745-1100

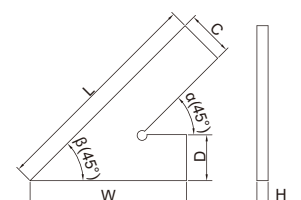

45° SQUARES WITH WIDE BASE

- Made of hardened stainless steel

Code	Size (LxW)	Accuracy		C	D	H	E
		Inside (α)	Outside (β)				
4747-100	100x70mm	27 μ m	31 μ m	20	20	5	20
4747-120	120x80mm	29 μ m	33 μ m	20	20	5	20
4747-150	150x100mm	32 μ m	36 μ m	20	20	5	20
4747-200	200x130mm	36 μ m	41 μ m	25	25	5	25

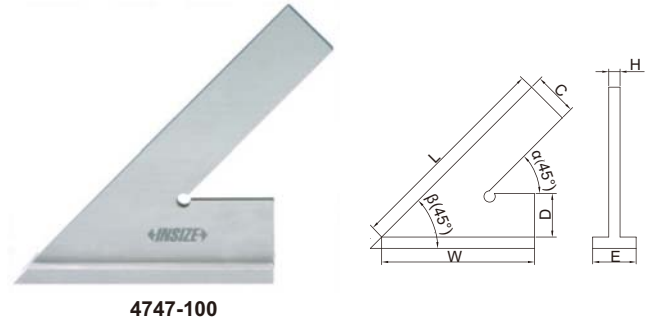

60° SQUARES

- Made of hardened stainless steel

Code	Size (LxW)	Accuracy		C	D	H
		Inside (α)	Outside (β)			
4760-1100	100x70mm	28 μ m	30 μ m	20	20	5
4760-1120	120x80mm	30 μ m	32 μ m	20	20	5
4760-1150	150x100mm	32 μ m	35 μ m	20	20	5
4760-1200	200x130mm	37 μ m	40 μ m	25	25	5

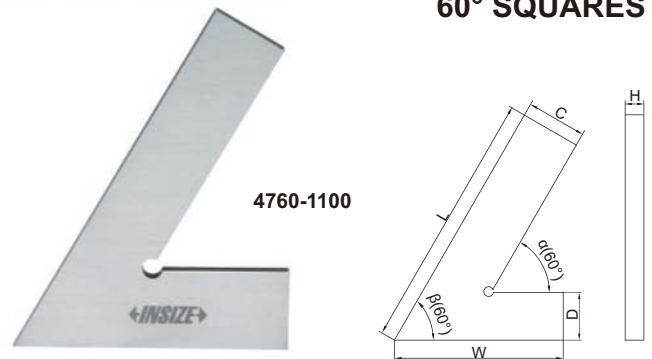

60° SQUARES WITH WIDE BASE

- Made of hardened stainless steel

Code	Size (LxW)	Accuracy		C	D	H	E
		Inside (α)	Outside (β)				
4762-100	100x70mm	28 μ m	31 μ m	20	20	5	20
4762-120	120x80mm	30 μ m	33 μ m	20	20	5	20
4762-150	150x100mm	33 μ m	36 μ m	20	20	5	20
4762-200	200x130mm	37 μ m	41 μ m	25	25	5	25

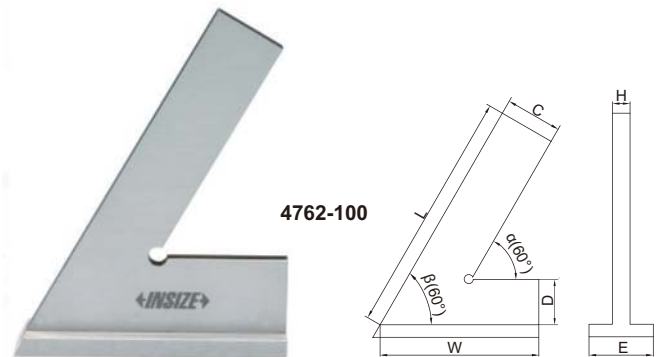

120° SQUARES

Code	Size (LxW)	Accuracy		C	D	H
		Inside (α)	Outside (β)			
4706-150	50x50mm	24 μ m	25 μ m	15	15	5
4706-175	75x75mm	26 μ m	28 μ m	20	20	5
4706-1100	100x100mm	29 μ m	30 μ m	20	20	5
4706-1150	150x150mm	34 μ m	35 μ m	25	25	5
4706-1200	200x200mm	38 μ m	40 μ m	30	30	7

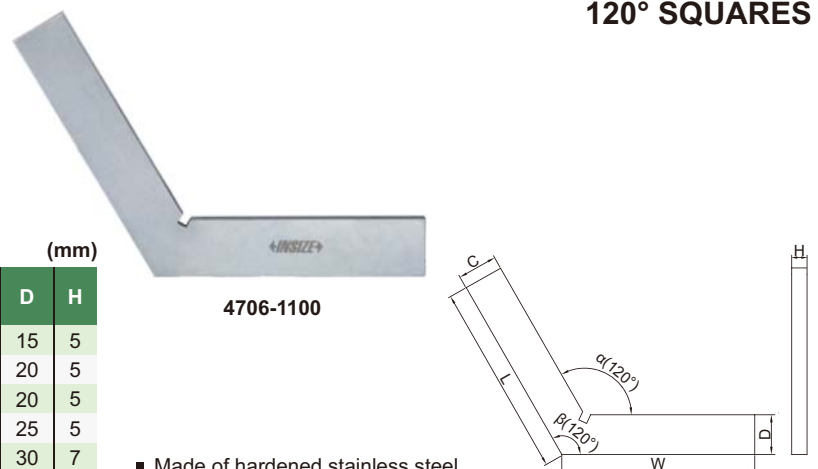

- Made of hardened stainless steel

135° SQUARES WITH WIDE BASE

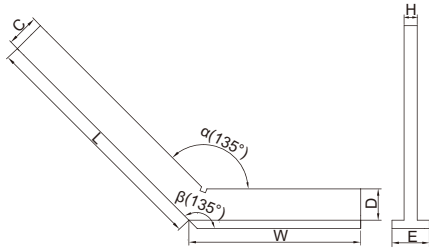

(mm)

Code	Size (LxW)	Accuracy		C	D	H	E
		Inside (α)	Outside (β)				
4754-3100	100x70mm	29μm	31μm	20	20	5	20
4754-3120	120x80mm	31μm	33μm	20	20	5	20
4754-3150	150x100mm	34μm	36μm	20	20	5	20
4754-3200	200x130mm	39μm	41μm	30	30	7	30
4754-3250	250x165mm	44μm	46μm	30	30	7	30
4754-3300	300x175mm	49μm	51μm	35	35	7	35



4754-3120

- Made of hardened stainless steel

STRAIGHT EDGES



4700-100

- DIN874
- Beveled edge
- Made of hardened stainless steel
- Satin chrome plating

(mm)

Code	Size (L)	Straightness	W	H
4700-50	50mm	2.2μm	5	20
4700-75	75mm	2.3μm	5	25
4700-100	100mm	2.4μm	5	25
4700-125	125mm	2.5μm	6	30
4700-150	150mm	2.6μm	6	30
4700-200	200mm	2.8μm	6	30
4700-250	250mm	3.0μm	8	40
4700-300	300mm	3.2μm	8	40
4700-400	400mm	3.6μm	10	50
4700-500	500mm	4.0μm	10	50

SQUARE SET

- Includes:
 - 90° tool maker square 25x20mm DIN875 grade 00 (code **4794-025**)
 - 90° tool maker square 40x28mm DIN875 grade 00 (code **4794-040**)
 - 90° beveled edge square 75x50mm DIN875 grade 00 (code **4790-075**)
 - straight edge 100mm DIN874 (code **4700-100**)
 - scriber
- Made of hardened stainless steel

Unit: mm

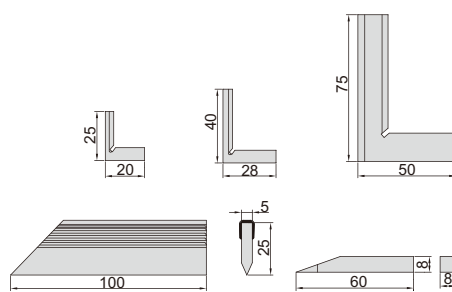

4702-1

Code
4702-1

GRANITE STRAIGHT EDGES

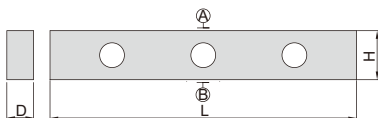

(mm)

Code	Length (L)	Flatness of A and B	Parallelism between A and B	D	H
4147-500A	500mm	2.1μm	3.2μm	50	80
4147-1000A	1000mm	3μm	4.5μm	60	120



4147-500A

MAGNALIUM STRAIGHT EDGES



4180-500

- Made of magnalium, light weight, non-deform, no rusty

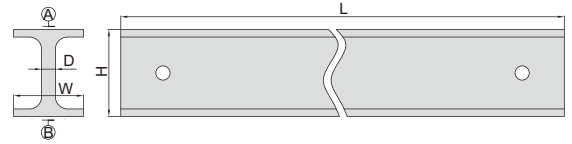

Code	Length (L)	Flatness of A and B	Parallelism between A and B	H	W	D
4180-500	500mm	3 μ m	4 μ m	60mm	30mm	5mm
4180-1000	1000mm	5 μ m	8 μ m	60mm	30mm	5mm
4180-1500	1500mm	15 μ m	22 μ m	100mm	40mm	5mm
4180-2000	2000mm	18 μ m	27 μ m	100mm	40mm	8mm

PRECISION STRAIGHT EDGES



7117-300

- Check flatness, straightness and for marking
- Made of tool steel

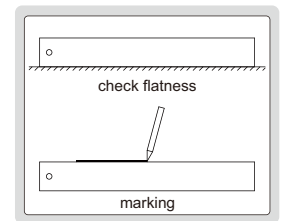
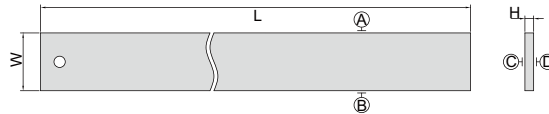

(mm)

Code	Range (L)	Straightness and parallelism of A and B	Straightness and parallelism of C and D	W	H
7117-300	305	0.005	0.05	41	6.3
7117-600	610	0.006	0.06	51	7.9
7117-900	914	0.007	0.06	64	9.5

PRECISION STRAIGHT EDGES WITH BEVELED EDGE



7118-300

- Check flatness, straightness and for marking
- Made of tool steel

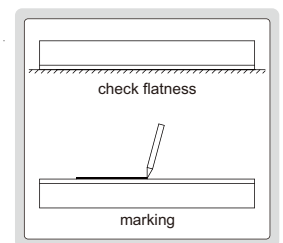
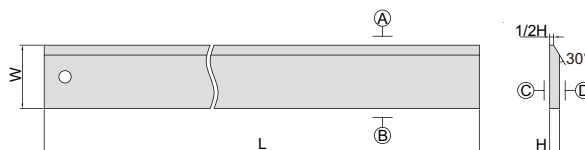

(mm)

Code	Range (L)	Straightness and parallelism of A and B	Straightness and parallelism of C and D	W	H
7118-300	305	0.005	0.05	41	6.3
7118-600	610	0.006	0.06	51	7.9
7118-900	914	0.007	0.06	64	9.5

FEELER GAGE

- Made of hardened alloy steel
- Meet DIN2275
- Accuracy: $\pm(3+T/80)$ μm ,
'T' is the thickness of leaves in μm



4601-25

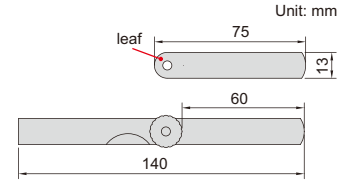

Code	Range	Thickness of leaves included (mm)	Quantity of leaves
4601-25	0.04-1.00mm	0.04, 0.05, 0.06, 0.07, 0.08, 0.09, 0.10, 0.15, 0.20, 0.25, 0.30, 0.35, 0.40, 0.45, 0.50, 0.55, 0.60, 0.65, 0.70, 0.75, 0.80, 0.85, 0.90, 0.95, 1.00	25

FEELER GAGES

- Made of hardened alloy steel
- Meet DIN2275
- Accuracy: $\pm(3+T/80)$ μm ,
'T' is the thickness of leaves in μm



4602-20

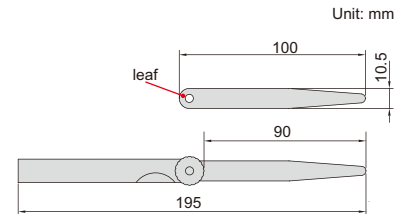

Code	Range	Thickness of leaves included (mm)	Quantity of leaves
4602-13A	0.03-0.50mm	0.03, 0.04, 0.05, 0.06, 0.07, 0.08, 0.09, 0.10, 0.15, 0.20, 0.30, 0.40, 0.50	13
4602-13	0.05-1.00mm	0.05, 0.10, 0.15, 0.20, 0.25, 0.30, 0.40, 0.50, 0.60, 0.70, 0.80, 0.90, 1.00	13
4602-17	0.02-1.00mm	0.02, 0.03, 0.04, 0.05, 0.06, 0.07, 0.08, 0.09, 0.10, 0.15, 0.20, 0.25, 0.30, 0.40, 0.50, 0.75, 1.00	17
4602-20	0.05-1.00mm	0.05, 0.10, 0.15, 0.20, 0.25, 0.30, 0.35, 0.40, 0.45, 0.50, 0.55, 0.60, 0.65, 0.70, 0.75, 0.80, 0.85, 0.90, 0.95, 1.00	20
4602-28	0.05-1.00mm	0.05, 0.06, 0.07, 0.08, 0.09, 0.10, 0.11, 0.12, 0.13, 0.14, 0.15, 0.20, 0.25, 0.30, 0.35, 0.40, 0.45, 0.50, 0.55, 0.60, 0.65, 0.70, 0.75, 0.80, 0.85, 0.90, 0.95, 1.00	28
4602-32	0.03-1.00mm	0.03, 0.04, 0.05, 0.06, 0.07, 0.08, 0.09, 0.10, 0.13, 0.15, 0.18, 0.20, 0.23, 0.25, 0.28, 0.30, 0.33, 0.35, 0.38, 0.40, 0.45, 0.50, 0.55, 0.60, 0.63, 0.65, 0.70, 0.75, 0.80, 0.85, 0.90, 1.00	32

LONG FEELER GAGES

- Made of hardened alloy steel
- Meet DIN2275
- Accuracy: $\pm(3+T/80)$ μm ,
'T' is the thickness of leaves in μm



4605-20

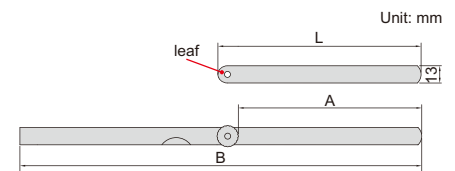

Code	Range	Thickness of leaves included (mm)	Quantity of leaves	L	A	B
4605-13	0.05-1.00mm	0.05, 0.10, 0.15, 0.20, 0.25, 0.30, 0.40, 0.50, 0.60, 0.70, 0.80, 0.90, 1.00	13	150	135	295
4605-131	0.05-1.00mm		13	200	185	395
4605-132	0.05-1.00mm		13	300	285	590
4605-20	0.05-1.00mm	0.05, 0.10, 0.15, 0.20, 0.25, 0.30, 0.35, 0.40, 0.45, 0.50, 0.55, 0.60, 0.65, 0.70, 0.75, 0.80, 0.85, 0.90, 0.95, 1.00	20	150	135	295
4605-201	0.05-1.00mm		20	200	185	395
4605-202	0.05-1.00mm		20	300	285	590

FEELER GAGE STOCKS



4622-10

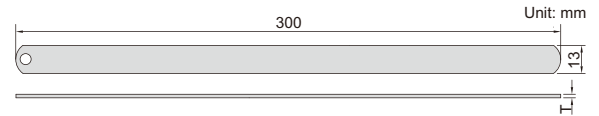

- Used as shims to accurately set spacing
- Made of hardened alloy steel
- Length 300mm
- Width 13mm
- 10pcs/package

Code	Thickness (T)	Accuracy
4622-02	0.02mm	±3µm
4622-03	0.03mm	±3µm
4622-04	0.04mm	±3µm
4622-05	0.05mm	±3µm
4622-06	0.06mm	±3µm
4622-07	0.07mm	±4µm
4622-08	0.08mm	±4µm
4622-09	0.09mm	±4µm
4622-10	0.10mm	±4µm
4622-12	0.12mm	±5µm

Code	Thickness (T)	Accuracy
4622-15	0.15mm	±5µm
4622-18	0.18mm	±6µm
4622-20	0.20mm	±6µm
4622-25	0.25mm	±6µm
4622-30	0.30mm	±7µm
4622-35	0.35mm	±7µm
4622-40	0.40mm	±8µm
4622-45	0.45mm	±8µm
4622-50	0.50mm	±9µm
4622-55	0.55mm	±9µm

Code	Thickness (T)	Accuracy
4622-60	0.60mm	±9µm
4622-65	0.65mm	±9µm
4622-70	0.70mm	±12µm
4622-75	0.75mm	±12µm
4622-80	0.80mm	±13µm
4622-85	0.85mm	±13µm
4622-90	0.90mm	±14µm
4622-95	0.95mm	±14µm
4622-100	1.00mm	±16µm

FEELER GAGE TAPES



4621-30

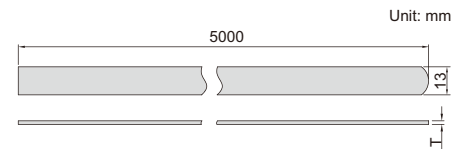

- Used as shims to accurately set spacing
- Made of hardened alloy steel
- Length 5m
- Width 13mm

Code	Thickness (T)	Accuracy
4621-02	0.02mm	±4µm
4621-03	0.03mm	±4µm
4621-04	0.04mm	±4µm
4621-05	0.05mm	±4µm
4621-06	0.06mm	±4µm
4621-07	0.07mm	±5µm
4621-08	0.08mm	±5µm
4621-09	0.09mm	±5µm
4621-10	0.10mm	±5µm
4621-12	0.12mm	±5µm

Code	Thickness (T)	Accuracy
4621-15	0.15mm	±6µm
4621-18	0.18mm	±7µm
4621-20	0.20mm	±8µm
4621-25	0.25mm	±9µm
4621-30	0.30mm	±9µm
4621-35	0.35mm	±11µm
4621-40	0.40mm	±12µm
4621-45	0.45mm	±12µm
4621-50	0.50mm	±14µm
4621-55	0.55mm	±14µm

Code	Thickness (T)	Accuracy
4621-60	0.60mm	±14µm
4621-65	0.65mm	±14µm
4621-70	0.70mm	±17µm
4621-75	0.75mm	±17µm
4621-80	0.80mm	±19µm
4621-85	0.85mm	±19µm
4621-90	0.90mm	±22µm
4621-95	0.95mm	±22µm
4621-100	1.00mm	±24µm

PITCH GAGES

- Check the pitch of screw thread
- Accuracy: ±0.07mm
- Made of medium carbon steel



4824-12

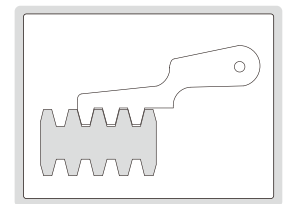

Code	Range	Thread type	Pitch of leaves included	Quantity of leaves
4824-12	2-20mm	Tr30°	2, 3, 4, 5, 6, 7, 8, 9, 10, 12, 16, 20mm	12
4824-16	1-12TPI	ACME29°	1, 1-1/3, 1-1/2, 1-3/4, 2, 2-1/2, 3, 3-1/2, 4, 5, 6, 7, 8, 9, 10, 12TPI	16

PITCH GAGES

- Check the pitch of screw thread
- Accuracy: $\pm 0.07\text{mm}$
- Made of medium carbon steel



4820-122

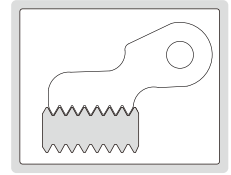

Metric 60° screw

Code	Range	Pitch of leaves included (mm)	Quantity of leaves
4820-122	0.4-7.0mm	0.4, 0.5, 0.6, 0.7, 0.75, 0.8, 0.9, 1, 1.25, 1.5, 1.75, 2, 2.5, 3, 3.5, 4, 4.5, 5, 5.5, 6, 6.5, 7	22
4820-124	0.25-7.0mm	0.25, 0.3, 0.35, 0.4, 0.5, 0.7, 0.75, 0.8, 0.9, 1, 1.25, 1.5, 1.75, 2, 2.5, 3, 3.5, 4, 4.5, 5, 5.5, 6, 6.5, 7	24
4820-1241	0.25-6.0mm	0.25, 0.3, 0.35, 0.4, 0.45, 0.5, 0.6, 0.7, 0.75, 0.8, 0.9, 1, 1.25, 1.5, 1.75, 2, 2.5, 3, 3.5, 4, 4.5, 5, 5.5, 6	24

Unified 60° screw

Code	Range	Pitch of leaves included	Quantity of leaves
4820-230	4-42TPI	4, 4-1/2, 5, 5-1/2, 6, 7, 8, 9, 10, 11, 11-1/2, 12, 13, 14, 15, 16, 18, 20, 22, 24, 26, 27, 28, 30, 32, 34, 36, 38, 40, 42TPI	30

Whitworth 55° screw

Code	Range	Pitch of leaves included	Quantity of leaves
4820-330	4-42TPI	4, 4-1/2, 5, 5-1/2, 6, 7, 8, 9, 10, 11, 12, 13, 14, 15, 16, 18, 19, 20, 22, 24, 26, 27, 28, 30, 32, 34, 36, 38, 40, 42TPI	30
4820-328	4-62TPI	4, 4-1/2, 5, 6, 7, 8, 9, 10, 11, 12, 13, 14, 16, 18, 19, 20, 22, 24, 25, 26, 28, 30, 32, 36, 40, 48, 60, 62TPI	28

Metric 60° and Whitworth 55° screw

Code	Range	Pitch of leaves included	Quantity of leaves
4820-452	0.25-6.0mm	0.25, 0.3, 0.35, 0.4, 0.45, 0.5, 0.6, 0.7, 0.75, 0.8, 0.9, 1, 1.25, 1.5, 1.75, 2, 2.5, 3, 3.5, 4, 4.5, 5, 5.5, 6mm	52
	4-62TPI	4, 4-1/2, 5, 6, 7, 8, 9, 10, 11, 12, 13, 14, 16, 18, 19, 20, 22, 24, 25, 26, 28, 30, 32, 36, 40, 48, 60, 62TPI	
4820-450	0.4-7.0mm	0.4, 0.5, 0.6, 0.7, 0.75, 0.8, 0.9, 1, 1.25, 1.5, 1.75, 2, 2.5, 3, 3.5, 4, 4.5, 5, 5.5, 6, 6.5, 7mm	50
	4-62TPI	4, 4-1/2, 5, 6, 7, 8, 9, 10, 11, 12, 13, 14, 16, 18, 19, 20, 22, 24, 25, 26, 28, 30, 32, 36, 40, 48, 60, 62TPI	

Metric 60° and Unified 60° screw

Code	Range	Pitch of leaves included	Quantity of leaves
4820-552	0.4-7.0mm	0.4, 0.5, 0.6, 0.7, 0.75, 0.8, 0.9, 1, 1.25, 1.5, 1.75, 2, 2.5, 3, 3.5, 4, 4.5, 5, 5.5, 6, 6.5, 7mm	52
	4-42TPI	4, 4-1/2, 5, 5-1/2, 6, 7, 8, 9, 10, 11, 11-1/2, 12, 13, 14, 15, 16, 18, 20, 22, 24, 26, 27, 28, 30, 32, 34, 36, 38, 40, 42TPI	

CENTER GAGES

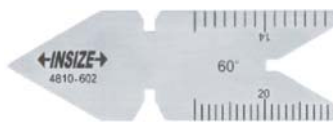

4810-602

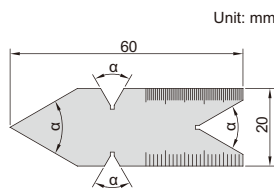

- To check and set screw cutting tools, and check the angle and pitch of screw thread
- Angle accuracy: $\pm 30\text{min}$.
- Made of stainless steel

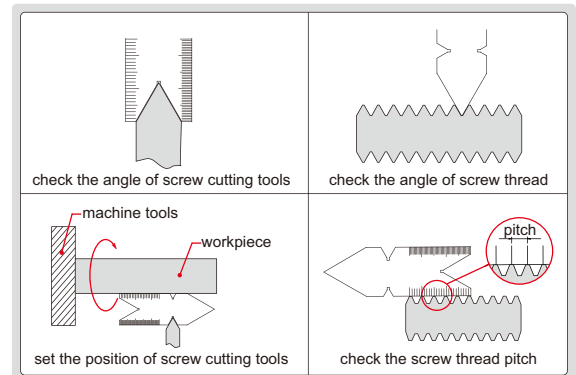

Code	Thread type	Angle (α)	Graduation
4810-601	METRIC 60°	60°	0.5mm and 1mm
4810-602	UNIFIED 60°	60°	14ths and 20ths on front side, 24ths and 32ths on back side
4810-55	WHITWORTH 55°	55°	14ths and 20ths on front side, 24ths and 32ths on back side

THREAD GAGES



4812-E

- To check and set screw cutting tools
- Angle accuracy: $\pm 10\text{min}$.
- Made of medium carbon steel

Code	Range	Thread type	Pitch
4812-12	2-12mm	Tr30°	2, 3, 4, 5, 6, 7, 8, 9, 10, 12mm
4812-E	1-10TPI	ACME29°	1, 1-1/3, 1-1/2, 1-3/4, 2, 2-1/2, 3, 4, 5, 6, 7, 8, 9, 10TPI

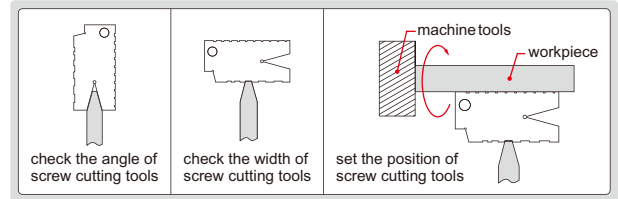
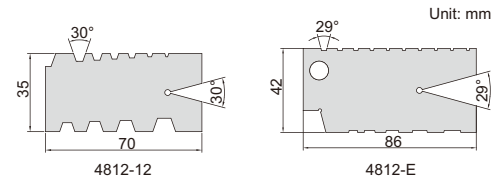

ANGLE GAGE



4806-20

- To check complementary angles
- Made of stainless steel

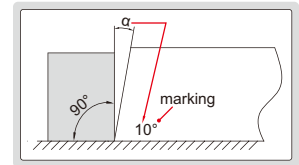

Code	Range	Angle of leaves included	Quantity of leaves	Accuracy
4806-20	1°-45°	1°, 2°, 3°, 4°, 5°, 6°, 7°, 8°, 9°, 10°, 12°, 14°, 16°, 18°, 20°, 25°, 30°, 35°, 40°, 45°	20	$\pm 30'$

ANGLE GAGE SET



4807

- Each blade checks primary, 1/2 primary and complementary angles
- Made of medium carbon steel

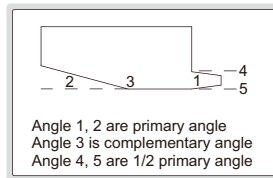

type A

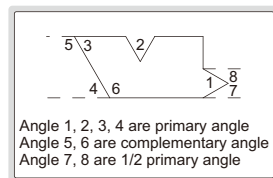

type B

Code	Quantity of leaves	Accuracy
4807	18	$\pm 10'$

Primary angle	1/2 primary angle	Complementary angle	Type
5°	2°30'	175°	A
10°	5°	170°	A
15°	7°30'	165°	A
20°	10°	160°	B
25°	12°30'	155°	B
30°	15°	150°	B
35°	17°30'	145°	B
40°	20°	140°	B
45°	22°30'	135°	B
50°	25°	130°	B
55°	27°30'	125°	B
60°	30°	120°	B
65°	32°30'	115°	B
70°	35°	110°	B
75°	37°30'	105°	B
80°	40°	100°	B
85°	42°30'	95°	B
90°	45°	90°	B

RADIUS GAGES



4801-17

- Made of medium carbon steel

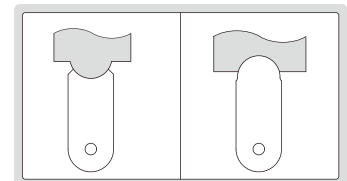

Code	Range	Radius of leaves included (mm)	Quantity of leaves (internal + external)	Accuracy
4801-17	1-7mm	1, 1.25, 1.5, 1.75, 2, 2.25, 2.5, 2.75, 3, 3.5, 4, 4.5, 5, 5.5, 6, 6.5, 7	17+17	$\pm 0.03\text{mm}$
4801-16	7.5-15mm	7.5, 8, 8.5, 9, 9.5, 10, 10.5, 11, 11.5, 12, 12.5, 13, 13.5, 14, 14.5, 15	16+16	$\pm 0.035\text{mm}$
4801-15	15.5-25mm	15.5, 16, 16.5, 17, 17.5, 18, 18.5, 19, 19.5, 20, 21, 22, 23, 24, 25	15+15	$\pm 0.042\text{mm}$

RADIUS GAGE

- Made of stainless steel

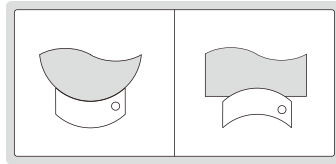

4802-31

Code	Range	Radius of leaves included (mm)	Quantity of leaves	Accuracy
4802-31	25-40mm	25, 25.5, 26, 26.5, 27, 27.5, 28, 28.5, 29, 29.5, 30, 30.5, 31, 31.5, 32, 32.5, 33, 33.5, 34, 34.5, 35, 35.5, 36, 36.5, 37, 37.5, 38, 38.5, 39, 39.5, 40	31pcs	±0.06mm

RADIUS GAGE SET

- Each piece has 3 concave and 2 convex gauging surfaces
- Supplied with handle
- Made of medium carbon steel

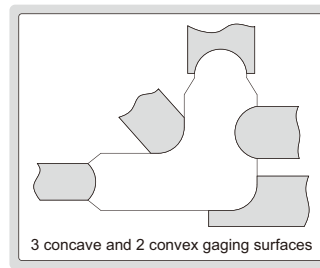

4804-26

Code	Range	Radius of leaves included (mm)	Quantity of leaves	Accuracy
4804-26	0.5 - 13mm	0.5, 1, 1.5, 2, 2.5, 3, 3.5, 4, 4.5, 5, 5.5, 6, 6.5, 7, 7.5, 8, 8.5, 9, 9.5, 10, 10.5, 11, 11.5, 12, 12.5, 13	26	±0.05mm

CHAMFER GAGE

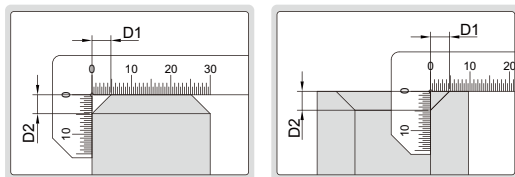

- To measure internal and external chamfers
- Made of stainless steel



4844-1

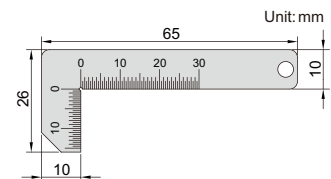

Code	Graduation	Accuracy
4844-1	0.5mm	±0.25mm

DIGITAL CHAMFER GAGE

- Measure 45° chamfer dimension
- Resolution: 0.01mm/0.0005"
- Buttons: on/off, set, mm/inch, preset (+, -)
- Automatic power off, move the digital unit to turn on power
- Battery CR2032
- Data output
- Made of stainless steel
- Optional accessory: data output cable (code 7306-20, 7302-SPC5A/SPC5B, 7305-SPC2A)



1180-6

preset buttons

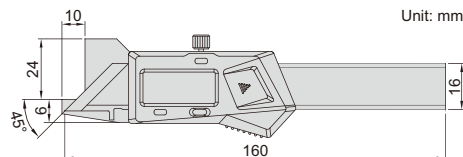
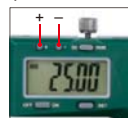

Unit: mm

DATA OUTPUT

measure 45° chamfer dimension

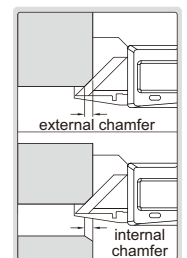

Code	Range	Accuracy
1180-6	0-6mm/0-0.24"	±0.06mm

CHAMFER GAGE

- Measure 45° chamfer dimension
- Graduation 0.02mm
- Made of stainless steel
- Satin chrome plated reading surface

Code	Range	Accuracy
1267-6	0-6mm	±0.06mm

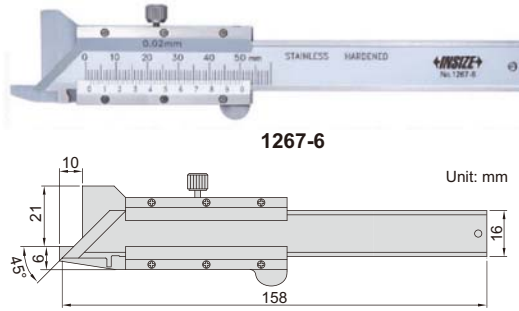

measure 45°
chamfer dimension

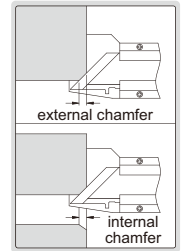

CHAMFER HEIGHT GAGE

principle of measurement

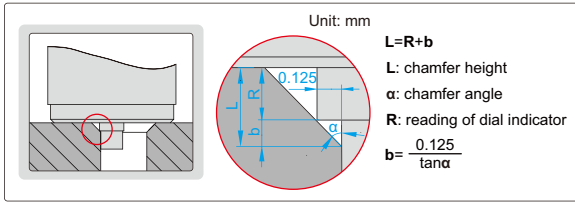

- Measure outside or inside chamfer height
- Suitable for diameter of bores ≥ 6mm, chamfer angle α ≥ 30°
- Setting gage is included

Code	Range (L)	Graduation	Accuracy
2943-1	0.2-5mm	0.01mm	±0.02mm



2943-1

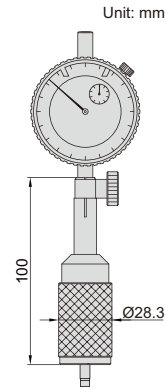

setting gage (included)



principle of measurement

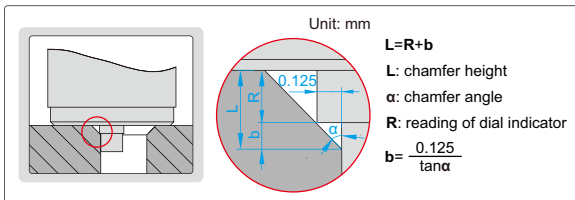

- Measure outside or inside chamfer height
- Suitable for diameter of bores ≥ 6mm, chamfer angle α ≥ 30°
- Resolution: 0.01mm/0.0005"
- Setting gage is included

Code	Range (L)	Accuracy
2944-1	0.2-5mm/0.008-0.197"	±0.02mm



2944-1

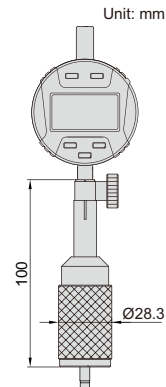

setting gage (included)



TAPER GAGES

- For quick measurement of gap width
- Stain chrome plated reading surface
- Made of stainless steel

Code	Range	Graduation	Accuracy	L	a	b
4630-3	0.4-6mm	0.05mm	±0.04mm	164	12.5	6.5
4630-1	0.5-10mm	0.05mm	±0.07mm	220	10	10.5
4630-2	0.5-15mm	0.1mm	±0.08mm	184	12.5	16.5

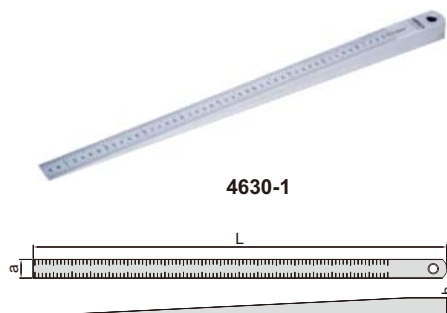

4630-1

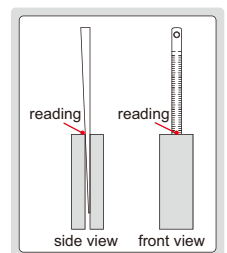

TAPER GAGES

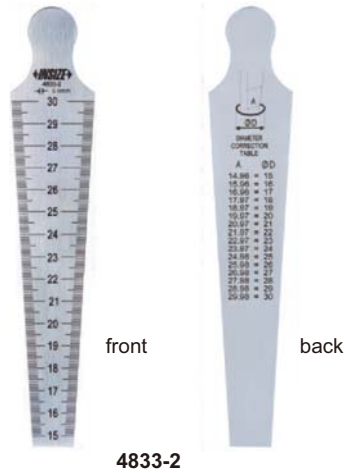
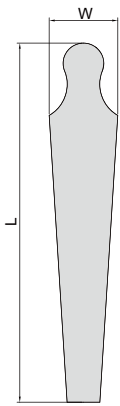

front

back

4833-2

measure diameter of hole

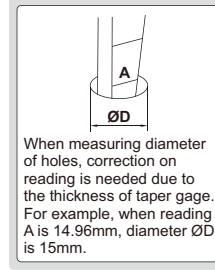

measure slot width

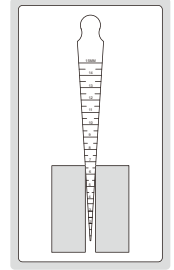

- Measure opening, slot width, hole diameter, etc.
- Diameter correction table on the back (only for 4833-1, 4833-2)
- Made of stainless steel

Code	Range	Graduation	Accuracy	L	W
4833-1	0.8-15mm	0.1mm	±0.1mm	146	17
4833-2	15-30mm	0.1mm	±0.1mm	159	30.4
4833-3	30-45mm	0.1mm	±0.1mm	166	45.4
4833-4	45-60mm	0.1mm	±0.1mm	170	60.5

TAPER GAGE SET

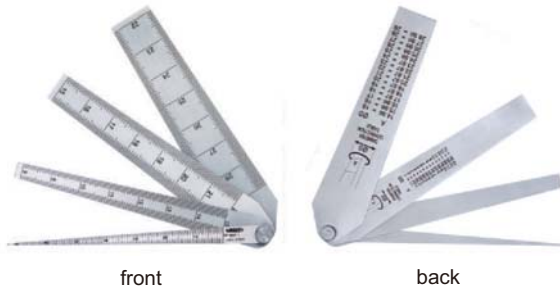

front

back

4837-1

measure diameter of hole

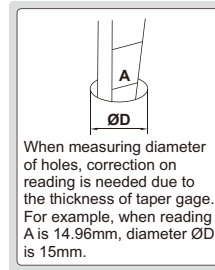

measure slot width

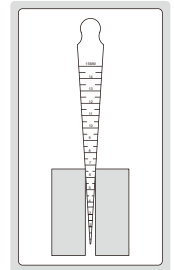

- Include 4pcs (1-8mm, 8-15mm, 15-22mm, 22-29mm)
- Measure opening, slot width, hole diameter, etc.
- Diameter correction table on the back
- Made of stainless steel

Unit: mm

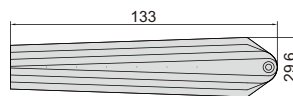

Code	Range	Graduation	Accuracy
4837-1	1-29mm	0.05mm	±0.05mm

WELDING GAGE



4830

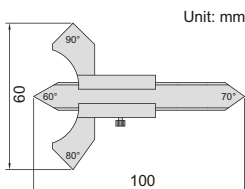

Unit: mm

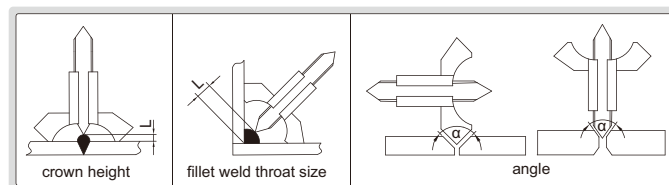

- Made of stainless steel
- Stain chrome plated reading surface

Code	Measurement	Range	Graduation	Accuracy
4830	crown height	0-8mm	0.1mm	±0.1mm
	fillet weld throat size	0-20mm	0.1mm	±0.3mm
	angle	60°, 70°, 80°, 90°	—	±1°

DIGITAL WELDING GAGE

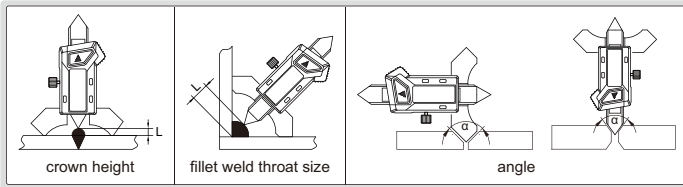

ATTENTION:
NO DATA OUTPUT

4831-20A

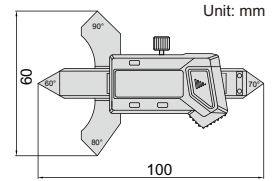

- Buttons: zero, mm/inch, on/off
- Battery LR44
- Made of stainless steel

Code	Measurement	Range	Resolution	Accuracy
4831-20A	crown height	0-7mm	0.01mm/0.0005"	±0.03mm
	fillet weld throat size	0-20mm	0.01mm/0.0005"	±0.1mm
	angle	60°, 70°, 80°, 90°	—	±1°

FILLET WELDING GAGE

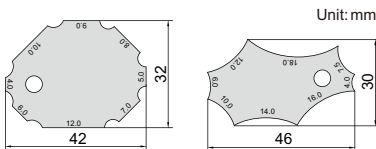

4832-1

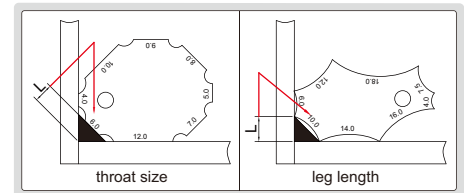

- Made of stainless steel
- Sizes marked on both faces

Code	Throat size	Leg length	Accuracy
4832-1	4, 5, 6, 7, 8, 9, 10, 12mm	4, 6, 7.5, 10, 12, 14, 16, 18mm	±0.5mm

FILLET WELDING GAGES

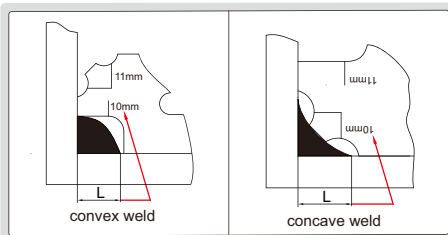

4836-1



4836-2

- Measure concave and convex weld sizes
- 7 blades are included
- Made of stainless steel

Code	Size	Accuracy
4836-1	3mm, 4mm, 5mm, 6mm, 8mm, 9mm, 10mm, 11mm, 12mm, 14mm, 16mm, 19mm, 22mm, 25mm	±0.5mm
4836-2	1/8" (3.2mm), 3/16" (4.8mm), 1/4" (6.4mm), 5/16" (7.9mm), 3/8" (9.5mm), 7/16" (11.1mm), 1/2" (12.7mm), 5/8" (15.9mm), 3/4" (19.1mm), 7/8" (22.2mm), 1" (25.4mm)	±0.02" (0.5mm)

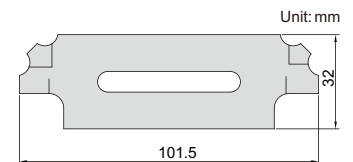

FILLET WELDING GAGE

- Measure convex weld sizes
- 3 blades are included
- Made of stainless steel

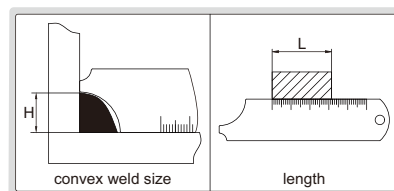

4847-1

Code	Measurement	Range	Graduation	Accuracy
4847-1	convex weld size	4, 6, 8, 10, 12, 14mm	—	±0.5mm
	length	0 - 50mm	1mm	±0.5mm

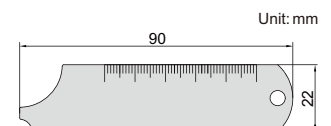

WELDING GAGE

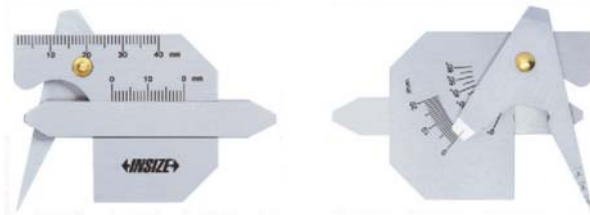

front

back

6832-1

- Made of stainless steel
- Stain chrome plated surface

Code	Measurement	Range	Graduation	Accuracy
6832-1	leg length	0-10mm	0.1mm	±0.1mm
	leg height	0-20mm	1mm	±0.5mm
	crown height	0-10mm	0.1mm	±0.1mm
	throat size	0-10mm	0.1mm	±0.1mm
	angle	0°-60°	5°	±1°
	gap	1-3.5mm	0.5mm	±0.5mm
	length	0-40mm	1mm	±0.5mm

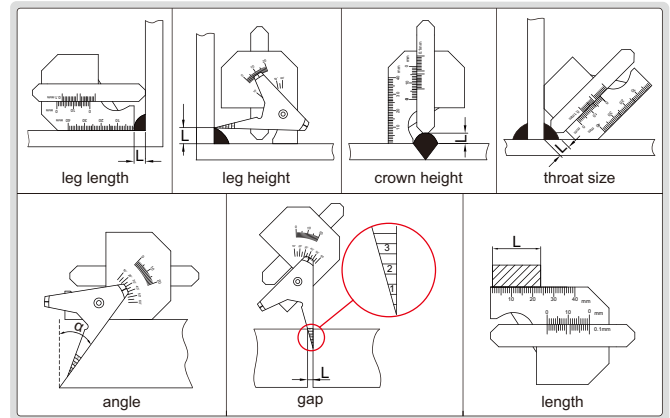
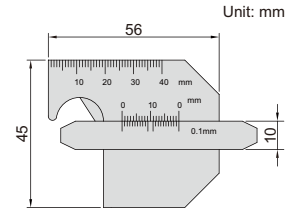

WELDING GAGES



front

back

4838-1

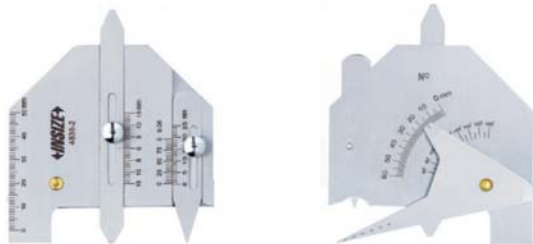

front

back

4838-2

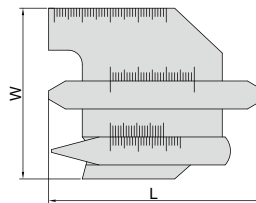

- Made of stainless steel

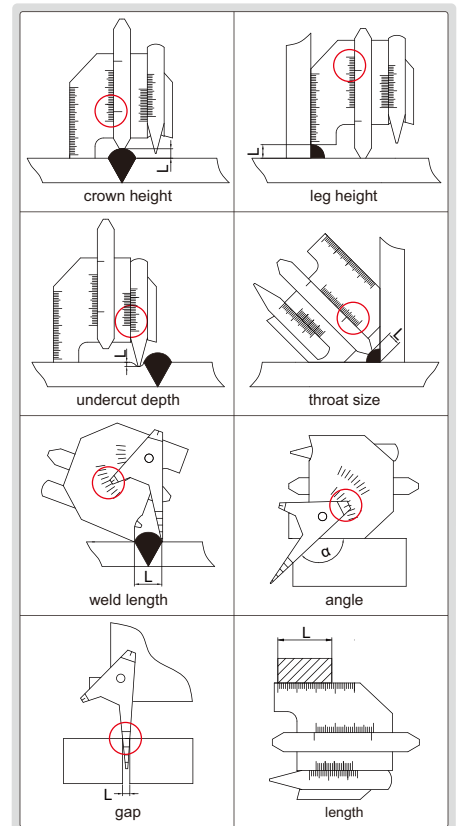

Code	4838-1			4838-2		
Measurement	Range	Graduation	Accuracy	Range	Graduation	Accuracy
crown height	0-10mm	1mm	±0.5mm	0-15mm	1mm	±0.5mm
leg height	0-14mm	1mm	±0.5mm	0-15mm	1mm	±0.5mm
undercut depth	0-5mm	0.05mm	±0.05mm	0-5mm	0.05mm	±0.05mm
throat size	0-13mm	1mm	±0.5mm	0-13mm	1mm	±0.5mm
weld length	0-40mm	1mm	±1mm	0-60mm	1mm	±1mm
angle	90°-150°	5°	±1°	80°-160°	5°	±1°
gap	0.5-5mm	1mm	±0.5mm	1-6mm	1mm	±0.5mm
length	0-40mm	1mm	±0.5mm	0-50mm	1mm	±0.5mm
LxW	62x77mm			99x84mm		

WELDING GAGE



front

back

4835-1

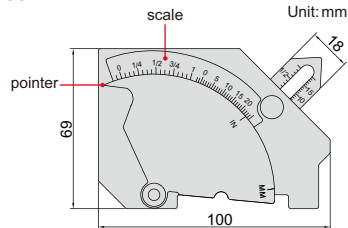

- Adjustable scale to compensate pointer wear
- Made of stainless steel

Code	Measurement	Range	Graduation	Accuracy
4835-1	crown height	0-25mm (0-1")	1mm (1/16")	±0.5mm
	fillet weld leg height	0-25mm (0-1")	1mm (1/16")	±0.5mm
	misalignment (high-low)	0-25mm (0-1")	1mm (1/16")	±0.5mm
	undercut depth	0-2mm (0-1/8")	1mm (1/16")	±0.5mm
	fillet weld throat size	0-20mm (0-3/4")	1mm (1/16")	±0.5mm
	angle of preparation	0-60°	5°	±1°
	length	0-60mm (0-2")	1mm (1/16")	±0.5mm
	45° angle	—	—	±1°

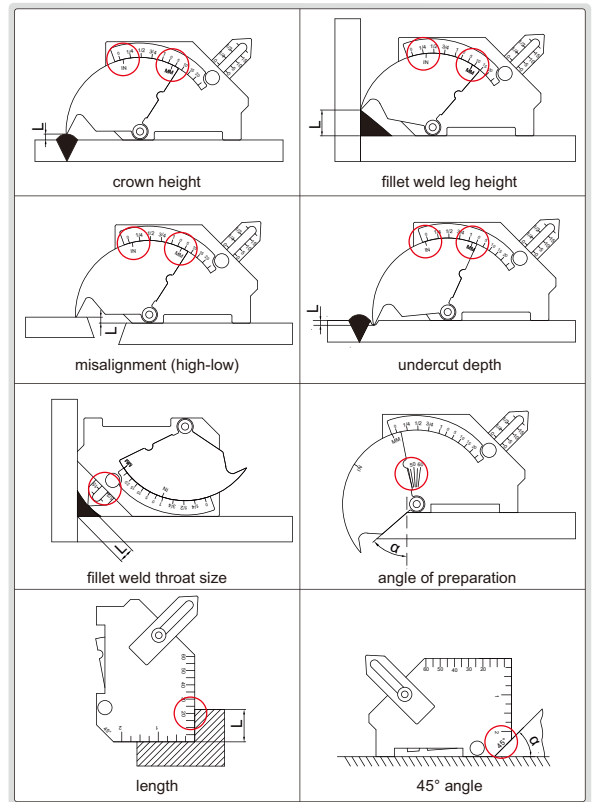

FILLET WELDING GAGE

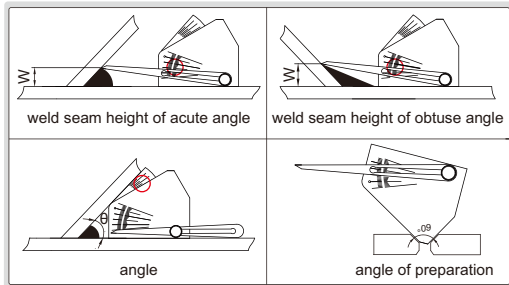

4846-1

- Calculating card is included
- Made of stainless steel

calculating card (included)

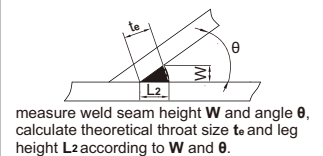
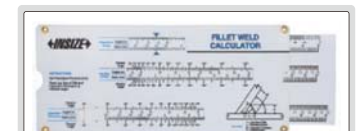

Code	Measurement	Range	Graduation	Accuracy
4846-1	weld seam height W	0-50mm/0-2"	2mm/.050"	±1mm
	angle θ	30°- 90°	2.5°	±1°
	60° angle	—	—	±0.5°

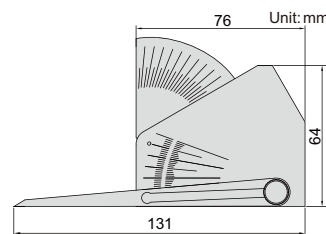

WELDING GAGE

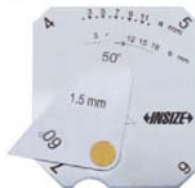
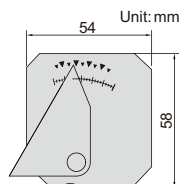

4850-1

- Made of stainless steel

Code	Measurement	Range	Graduation	Accuracy
4850-1	leg height (b)	2-12mm	1mm	±0.5mm
	theoretical throat size (a)	0-18mm	1mm	±0.5mm
	throat size	4, 5, 6, 7mm	—	±0.5mm
	angle of preparation	50°, 60°	—	±1°
	thickness	1.5, 2, 3.5mm	—	±0.2mm

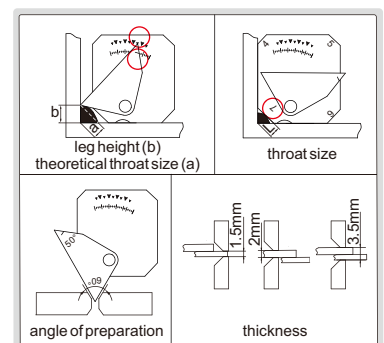

WELDING GAGE

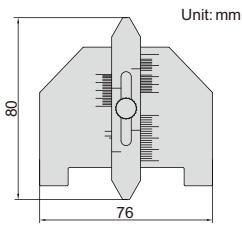

4851-1

- Made of stainless steel

Code	Measurement	Range	Graduation	Accuracy
4851-1	leg height	0-20mm	1mm	±0.5mm
	crown height	0-3mm	—	±0.5mm
	theoretical leg height of convex weld	0-20mm	1mm	±0.5mm
	theoretical leg height of concave weld	0-20mm	1mm	±0.5mm

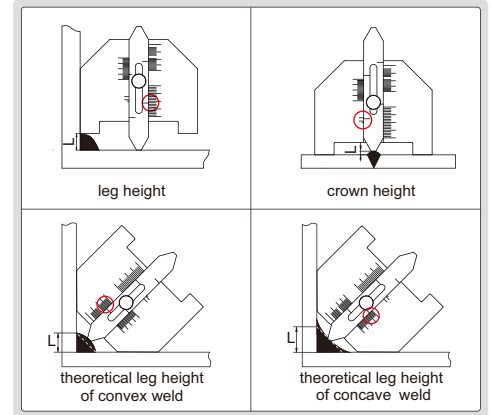

WELDING GAGE

- Pointer can be locked for later reference
- Made of stainless steel

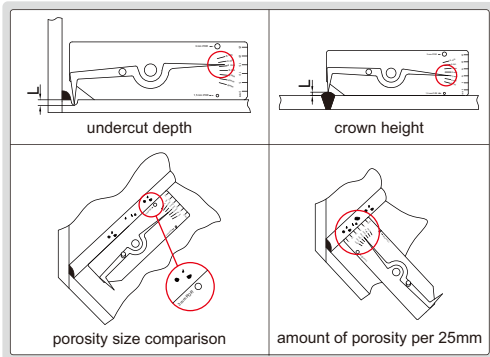

4834-1

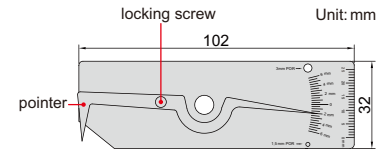

Code	Measurement	Range	Graduation	Accuracy
4834-1	undercut depth	0-6mm	0.5mm	±0.5mm
	crown height	0-6mm	0.5mm	±0.5mm
	porosity size comparison	1.5mm, 3mm	—	±0.2mm
	amount of porosity per 25mm	25mm	1mm	—

WELDING GAGE

- Made of stainless steel

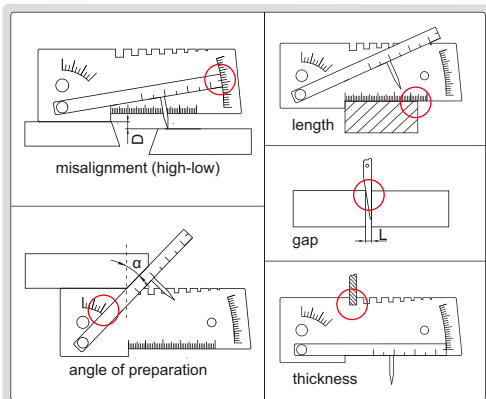

4848-1

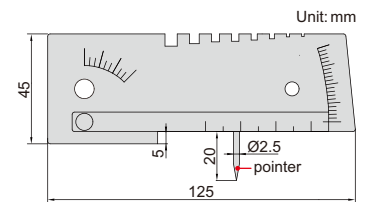

Code	Measurement	Range	Graduation	Accuracy
4848-1	misalignment (high-low)	-5mm~+15mm	1mm	±0.5mm
	angle of preparation	0°-45°	5°	±2.5°
	length	0-50mm	1mm	±0.5mm
	gap	1-4mm	0.5mm	±0.25mm
	thickness	1, 1.2, 2.0, 2.5, 3.0, 3.25, 4.0, 5.0mm	—	±0.1mm

WELDING GAGE

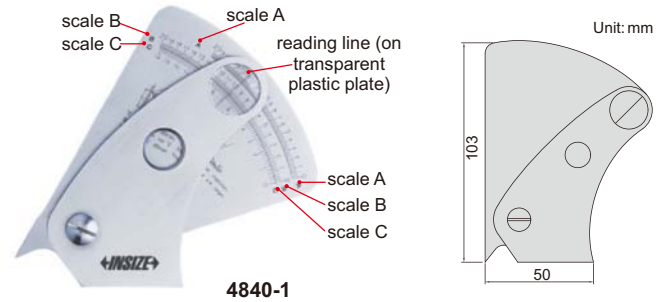
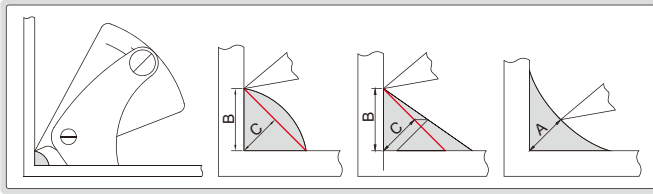

■ Made of stainless steel

Code	Graduation	Accuracy
4840-1	0.2mm	±0.3mm

PIPE WELDING GAGE

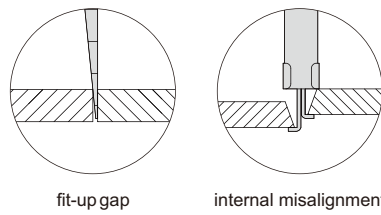

■ Made of stainless steel

Code	Measurement	Range	Graduation	Accuracy
4841-1	internal misalignment	0-30mm	1mm	±0.5mm
	fit-up gap	0.7-4mm	0.1mm	±0.1mm

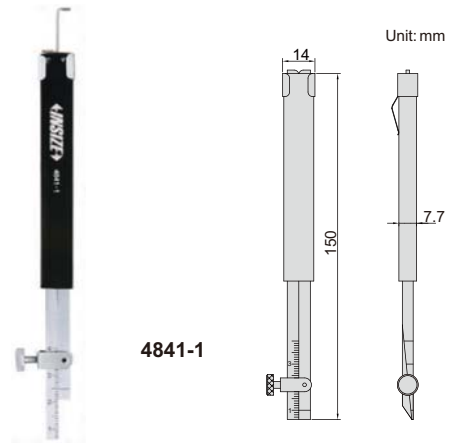

PIPE WELDING GAGE

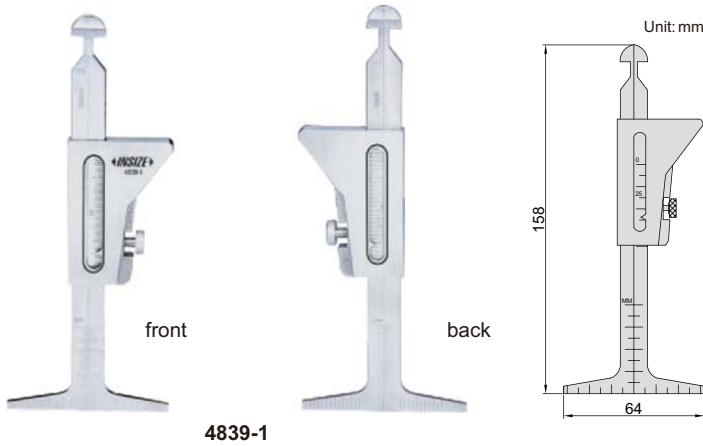

■ Made of stainless steel

Code	Measurement	Range	Graduation	Accuracy
4839-1	bevel on end preparation	37.5°	—	±1°
	pipe wall thickness	0-45mm (0-1-3/4")	1mm (1/16")	±0.5mm
	internal misalignment	0-35mm (0-1-3/8")	1mm (1/32")	±0.5mm
	fit-up gap	1.6mm, 2.4mm	—	±0.1mm
	crown height	0-35mm (0-1-3/8")	1mm (1/32")	±0.5mm
	distance between two marking lines of socket weld	0-60mm (0-2-3/8")	1mm (1/16")	±0.5mm
	fillet weld length	0-30mm (0-1-1/4")	1mm (1/16")	±0.5mm
	fillet weld height	0-35mm (0-1-3/8")	1mm (1/32")	±0.5mm

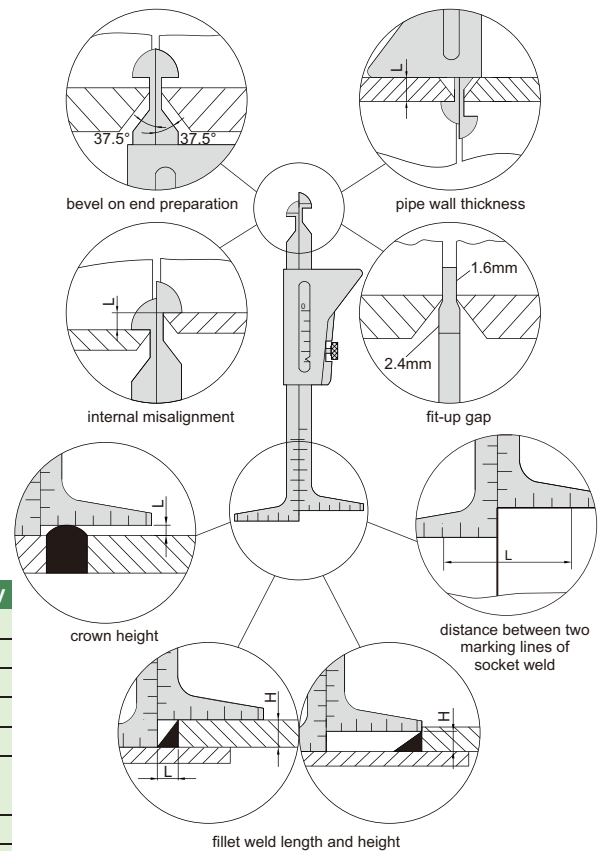

DRILL POINT GAGE

- For twist drills with 118° angle, to check if the center of tip is concentric with the drill body
- Made of stainless steel

Code	Accuracy	
	Angle	Length
4843-1	±0.5°	±0.5mm



4843-1

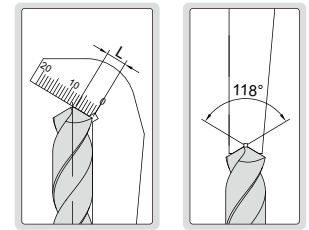
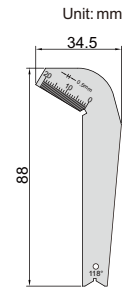

DRILL ANGLE GAGE

- Check drills with angle 60°, 70°, 90°, 118°, 125°, 135°, 150° or 160°
- Made of stainless steel

Code	Accuracy
4842-1	±0.5°



4842-1

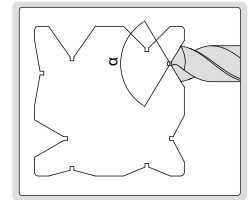
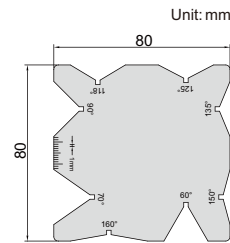

AMERICAN STANDARD WIRE GAGE

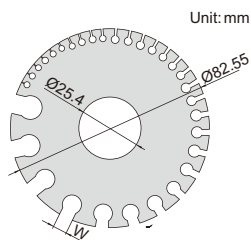

4808

- For gaging non-ferrous wire and metals such as copper, brass and aluminum
- Hardened and satin chrome finish

Code	Range
4808	0-36 (8.250-0.127mm/ .3249-.0050")

No.	W	No.	W	No.	W
0	8.250mm (.3249")	13	1.820mm (.0720")	26	0.404mm (.0159")
1	7.350mm (.2893")	14	1.630mm (.0641")	27	0.361mm (.0142")
2	6.540mm (.2576")	15	1.450mm (.0571")	28	0.320mm (.0126")
3	5.830mm (.2294")	16	1.290mm (.0508")	29	0.287mm (.0113")
4	5.190mm (.2043")	17	1.150mm (.0453")	30	0.254mm (.0100")
5	4.620mm (.1819")	18	1.020mm (.0403")	31	0.226mm (.0089")
6	4.110mm (.1620")	19	0.912mm (.0359")	32	0.203mm (.0080")
7	3.670mm (.1443")	20	0.813mm (.0320")	33	0.180mm (.0071")
8	3.260mm (.1285")	21	0.724mm (.0285")	34	0.160mm (.0063")
9	2.910mm (.1144")	22	0.643mm (.0253")	35	0.142mm (.0056")
10	2.590mm (.1019")	23	0.574mm (.0226")	36	0.127mm (.0050")
11	2.300mm (.0907")	24	0.511mm (.0201")		
12	2.050mm (.0808")	25	0.440mm (.0179")		

U.S. STANDARD SHEET METAL GAGE

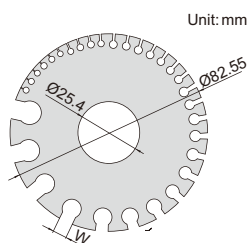

4809

- For gaging sheet metal, plate iron and steel
- Hardened and satin chrome finish

Code	Range
4809	0-36 (7.938-0.179mm/.3125-.0070")

No.	W	No.	W	No.	W
0	7.938mm (.3125")	13	2.381mm (.0938")	26	0.476mm (.0188")
1	7.144mm (.2813")	14	1.984mm (.0781")	27	0.437mm (.0172")
2	6.747mm (.2656")	15	1.786mm (.0703")	28	0.397mm (.0156")
3	6.350mm (.2500")	16	1.588mm (.0625")	29	0.357mm (.0141")
4	5.953mm (.2344")	17	1.429mm (.0563")	30	0.318mm (.0125")
5	5.556mm (.2188")	18	1.270mm (.0500")	31	0.278mm (.0109")
6	5.159mm (.2031")	19	1.111mm (.0438")	32	0.258mm (.0102")
7	4.763mm (.1875")	20	0.953mm (.0375")	33	0.238mm (.0094")
8	4.366mm (.1719")	21	0.873mm (.0344")	34	0.218mm (.0086")
9	3.969mm (.1563")	22	0.794mm (.0313")	35	0.198mm (.0078")
10	3.572mm (.1406")	23	0.714mm (.0281")	36	0.179mm (.0070")
11	3.175mm (.1250")	24	0.635mm (.0250")		
12	2.778mm (.1094")	25	0.556mm (.0219")		

INSIDE CALIPERS

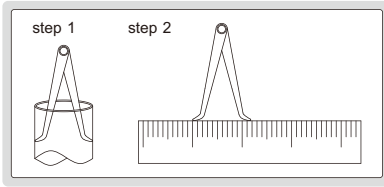

■ Made of carbon steel

Code	Size (L)	Range (W)	h
7240-150	150mm	17-150mm	2mm
7240-200	200mm	17-200mm	3mm
7240-300	300mm	18-300mm	3mm



7240-150

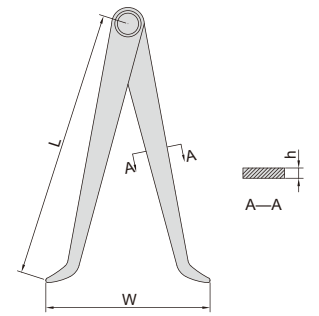

OUTSIDE CALIPERS

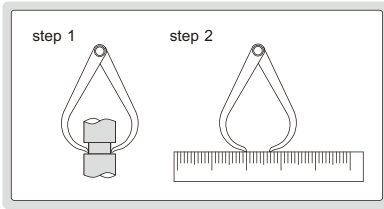

■ Made of carbon steel

Code	Size (L)	Range (W)	h
7241-150	150mm	0-150mm	2mm
7241-200	200mm	0-200mm	3mm
7241-300	300mm	0-300mm	3mm



7241-150

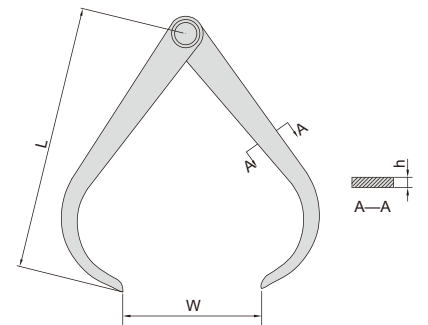

INSIDE SPRING CALIPERS

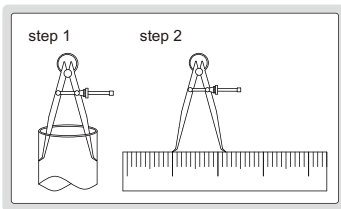

Code	Size (L)	Range (W)
7261-150	150mm	20-170mm
7261-200	200mm	22-220mm
7261-250	245mm	30-270mm
7261-300	300mm	30-320mm

■ Made of carbon steel



tips



7261-150

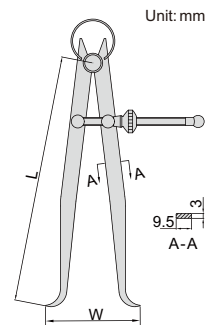

OUTSIDE SPRING CALIPERS

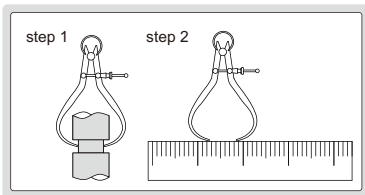

Code	Size (L)	Range (W)
7262-150	155mm	0-140mm
7262-200	210mm	0-210mm
7262-250	265mm	0-270mm
7262-300	310mm	0-320mm

■ Made of carbon steel



tips



7262-150

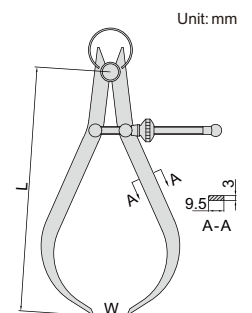

SPRING DIVIDERS

- Made of carbon steel
- Hardened points



7260-150

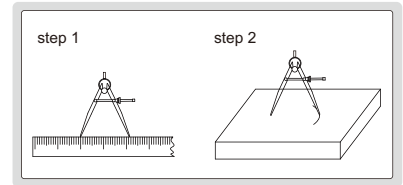
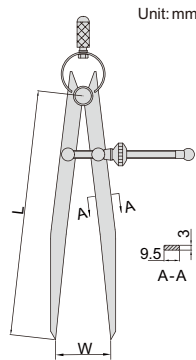

Code	Size (L)	Range (W)
7260-150	150mm	0-150mm
7260-200	200mm	0-210mm
7260-250	245mm	0-260mm
7260-300	300mm	0-320mm

DIVIDERS

- Made of carbon steel
- Hardened points



7247-150

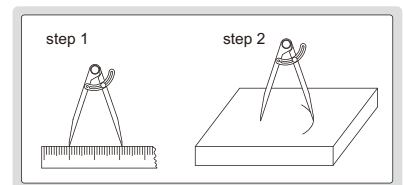
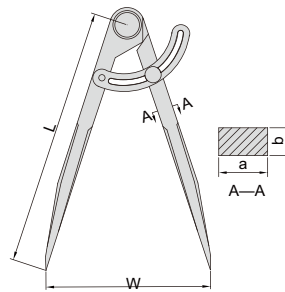

Code	Size (L)	Range (W)	(mm)	
			a	b
7247-150	150mm	0-140mm	8.5	7
7247-200	200mm	0-190mm	10	7
7247-300	300mm	0-290mm	12	7

MEASURING TAPES

EG II



7140-5

packaging

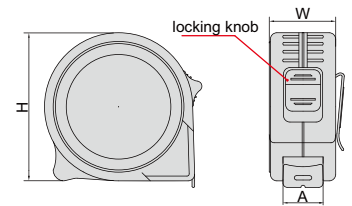

Code	Range	Graduation	Width of tape A	W	H
7140-3	0-3m	1mm	16mm	28	62
7140-5	0-5m	1mm	19mm	30	68
7140-8	0-8m	1mm	25mm	38	78

WOODEN FOLDING RULE

closed



7124-210

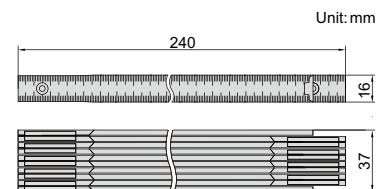

Code	Range	Graduation
7124-210	2m	1mm



FLEXIBLE RULES

- Flexible use
- Graduation on both sides
- Made of special alloy steel
- Satin chrome plated



7121-150



flexible use

Code	Range (L)	Graduation	Accuracy	W	T
7121-150	150mm	0.5mm/1mm	+0.10/-0.09mm	12.50mm	0.40mm
7121-300	300mm	0.5mm/1mm	+0.13/-0.09mm	12.50mm	0.40mm
7121-600	600mm	0.5mm/1mm	+0.18/-0.09mm	19.50mm	0.50mm

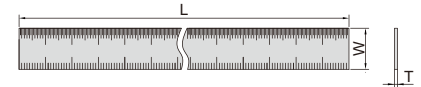

RIGID RULES

- Rigid rule
- Graduation on both sides
- Made of special alloy steel
- Satin chrome plated



7122-300

Code	Range (L)	Graduation	Accuracy	W	T
7122-150	150mm	0.5mm/1mm	+0.10/-0.09mm	18.50mm	1mm
7122-300	300mm	0.5mm/1mm	+0.13/-0.09mm	24.50mm	1mm
7122-600	600mm	0.5mm/1mm	+0.18/-0.09mm	29.50mm	1mm

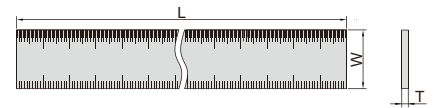

RIGID RULE

- Rigid rules
- With groove on the back, suitable for combination square set (code 2278-180)
- Satin chrome plated



groove on the back

7113-300A

Code	Range	Graduation		Accuracy	L
		front	back		
7113-300A	300mm/12"	0.5mm and 1/32"	1mm and 1/64"	±0.15mm	300mm

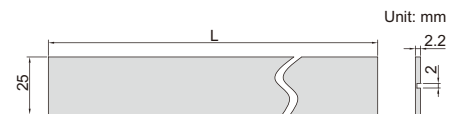

Unit: mm

POCKET RULE WITH SLIDING CLIP



7119-150

- With sliding clip, clip also can be used as depth gage base
- With inch/metric conversion table on the back
- Made of stainless steel

Code	Range	Graduation	Accuracy
7119-150	150mm/6"	1mm, 1/64"	±0.15mm

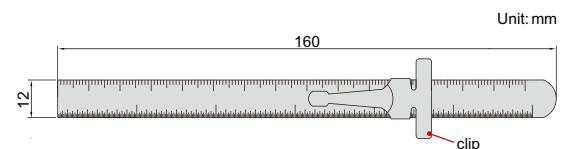

Unit: mm

STEEL RULES

ATTENTION:
BASIC MODEL

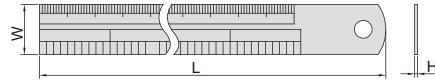

7110-300

(mm)

- Graduation: 0.5mm, 1mm, 1/64", 1/32", 1/16"
- Semi-flexible rules
- Made of stainless steel
- Non-glare surface

Code	Range	Accuracy	L	W	H	Remark
7110-150	150mm/6"	±0.15mm	170	18	1.0	graduation on front and back
7110-200	200mm/8"	±0.15mm	220	18	1.0	graduation on front and back
7110-300	300mm/12"	±0.15mm	330	25	1.0	graduation on front and back
7110-3001	300mm/12"	±0.15mm	325	30	1.0	graduation on front and back
7110-500	500mm/20"	±0.15mm	530	30	1.2	graduation on front and back
7110-600	600mm/24"	±0.20mm	630	30	1.2	graduation on front and back
7110-1000	1000mm/40"	±0.20mm	1040	32	1.5	graduation on front and back
7110-1200	1200mm/48"	±0.22mm	1240	35	1.8	graduation on front
7110-1500	1500mm/60"	±0.25mm	1550	38	1.8	graduation on front
7110-2000	2000mm/80"	±0.30mm	2065	40	2.0	graduation on front

STRAIGHT EDGES



7111-300A

Unit: mm

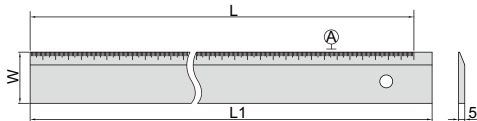

- Check flatness and straightness, as well as for marking
- Graduation on the beveled edge
- Made of hardened tool steel
- Chrome plated

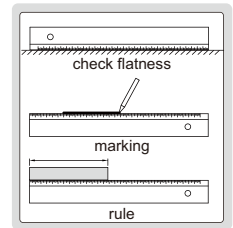

(mm)

Code	Range (L)	Straightness of A	L1	W
7111-300A	300mm	0.02mm	320	40
7111-500A	500mm	0.03mm	520	40
7111-1000A	1000mm	0.04mm	1020	50

MARKING GAGES



7120-200A

- Made of carbon steel
- Satin chrome plated

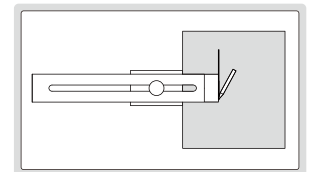
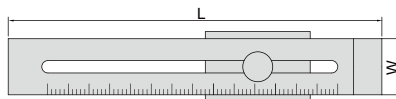

(mm)

Code	Range	Graduation	Accuracy	L	W
7120-200A	0-200mm	0.1mm	±0.1mm	250	40
7120-250A	0-250mm	0.1mm	±0.1mm	300	40
7120-300A	0-300mm	0.1mm	±0.1mm	350	40

T-SHAPE MARKING GAGE

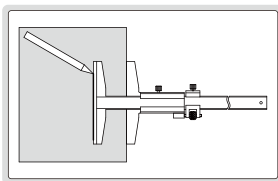

1275-150A

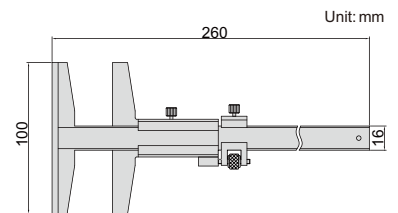

Unit: mm

- Made of stainless steel
- Satin chrome plated reading surface

Code	Range	Graduation	Accuracy
1275-150A	0-150mm	0.05mm	±0.05mm

COMBINATION SQUARE SETS



2278-2



2278-3

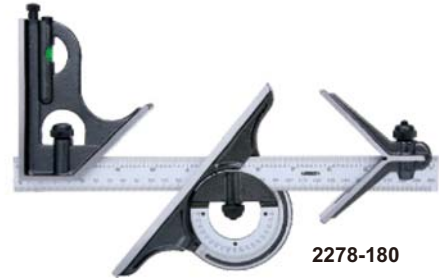

2278-180

- Center head (made of cast iron):
To locate center of cylinder with diameter (Ød): 30-100mm
Accuracy: ±0.15mm
- Protractor head (made of cast iron):
To set the blade at desired angle to an edge of a workpiece, and can be used to measure angles
Range: 0-180°
Accuracy: ±7min.
- Square head (made of cast iron):
To set the blade at 90° or 45° to an edge of a workpiece
Accuracy: ±8min for 90° square, ±10min for 45° square
- Blade (made of stainless steel):
Range: 300mm/12",
Graduation: 0.5mm and 1/32" on front face, 1mm and 1/64" on back face
- Optional accessory: rigid rule (code 7113)

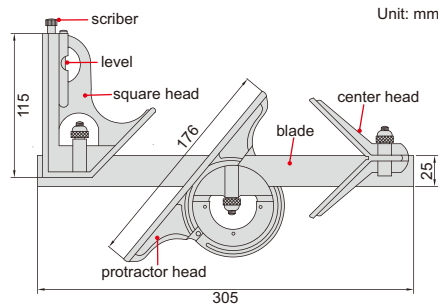

Code	Remark
2278-2	2-piece set
2278-3	3-piece set
2278-180	4-piece set

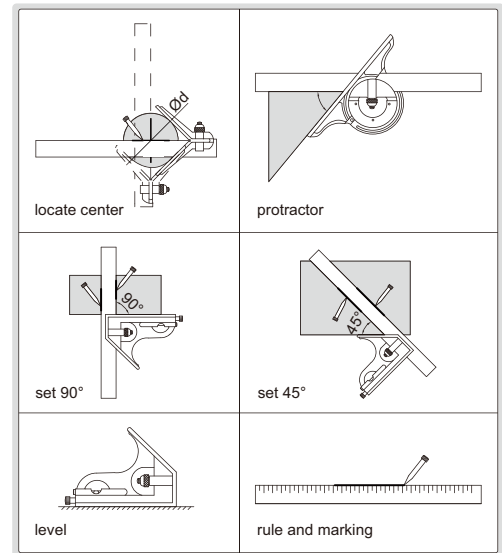

- Square head (made of zinc):
To set the blade at 90° or 45° to an edge of a workpiece
Accuracy: ±0.5°
- Blade (made of stainless steel):
Range: 300mm,
Graduation: 0.5mm and 1mm on front and back sides

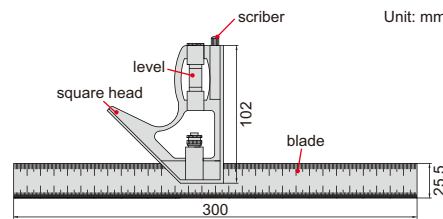
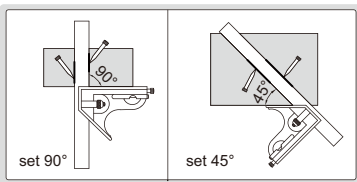

Code
2276-300

LIGHT DUTY COMBINATION SQUARE



2276-300

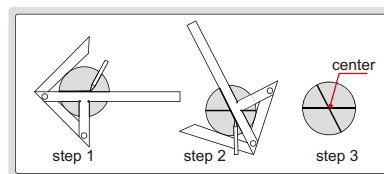
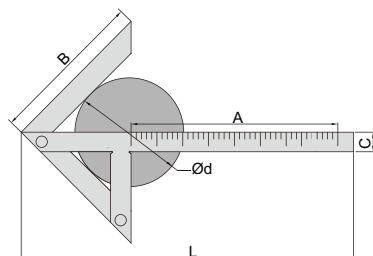

(mm)

Code	Size (AxB)	Diameter of shafts (Ød)	Accuracy	C	L
7205-100	100X70mm	4-90mm	±0.15mm	12	153
7205-150	150x130mm	4-190mm	±0.15mm	15	245
7205-200	200x150mm	6-220mm	±0.15mm	15	310

CENTER MARKING GAGES



7205-100

- Marking the center of round plates and shafts
- Made of stainless steel
- Satin chrome plated

SCRIBING CALIPER

- Made of stainless steel
- Satin chrome plated reading surface
- Carbide scriber tip

the position of scriber tip can be adjusted



7202-200A

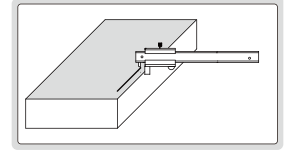
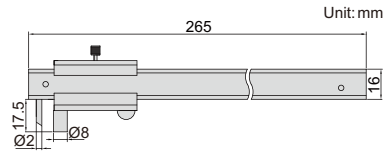

Code	Range	Graduation	Accuracy
7202-200A	0-200mm/0-8"	0.1mm, 1/128"	±0.1mm

DIGITAL SCRIBING CALIPERS

- The carbide-tipped jaws facilitate scribing on workpieces
- Resolution: 0.01mm/0.0005"
- Buttons: on/off, zero, mm/inch
- Automatic power off, move the digital unit to turn on power
- Battery CR2032, data output
- Made of stainless steel
- Optional accessory: data output cable (code 7306-20, 7302-SPC5A/SPC5B, 7305-SPC2A)



1166-150A

DATA OUTPUT

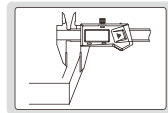
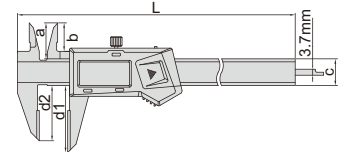

Code	Range	Accuracy	L	a	b	c	d1	d2
1166-150A	0-150mm/0-6"	±0.03mm	236	21	16.5	16	40	33
1166-200A	0-200mm/0-8"	±0.03mm	286	24	19.5	16	50	43
1166-300A	0-300mm/0-12"	±0.04mm	400	25	20.5	17	60	53

SCRIBING CALIPER

- Made of stainless steel
- Satin chrome plated reading surface
- Hardened scriber tips

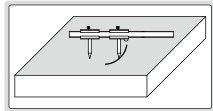

7203-300A

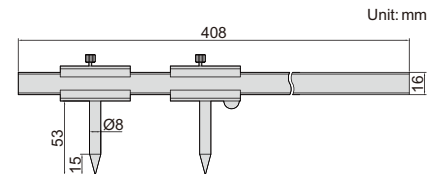

Code	Range	Graduation	Accuracy
7203-300A	51-300mm	0.1mm	±0.1mm

HEIGHT SCRIBER

- Grooved bottom for cylinder
- Two pins to be set against the edge of surface plate

6990-300A

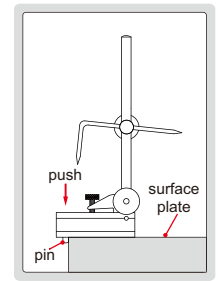
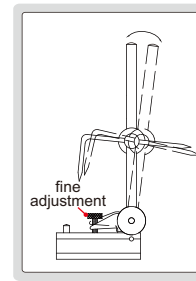
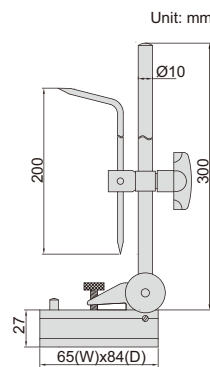

Code
6990-300A

SCRIBERS

- Nickel plated

Code	Tip
7230	hardened tips
7231	hardened tip
7232	carbide tip



7230

7231

7232

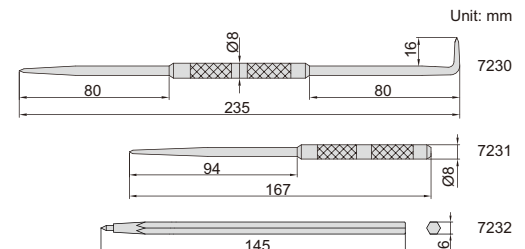

2-PIECE MEASURING TOOL SETS

- Includes:
 - 1) Vernier caliper, range 0-150mm/0-6"
 - 2) Outside micrometer, range 0-25mm, graduation 0.01mm (code 3202-25A)

Code	Remark
5021	Vernier caliper, graduation 0.05mm/1/128" (code 1205-150S)
5021-2	Vernier caliper, graduation 0.02mm/0.001" (code 1205-1502S)



5021

2-PIECE MEASURING TOOL SET

- Includes:
 - 1) Digital caliper, range 0-150mm/0-6", resolution 0.01mm/0.0005" (code 1108-150)
 - 2) Digital outside micrometer, range 0-25mm/0-1", resolution 0.001mm/0.00005" (code 3109-25B)

Code
5022



5022

2-PIECE MEASURING TOOL SET

- Includes:
 - 1) Dial test indicator, range 0.8mm, graduation 0.01mm (code 2380-08)
 - 2) Magnetic stand

Code
5023



5023

2-PIECE MEASURING TOOL SET

- Includes:
 - 1) Dial indicator, range 10mm, graduation 0.01mm (code 2308-10A)
 - 2) Magnetic stand (code 6201-60)

Code
5024



5024

3-PIECE MEASURING TOOL SET

Includes:

- 1) Digital indicator, range 12.7mm/0.5", resolution 0.01mm/0.0005" (code **2112-10**)
- 2) Flex arm
- 3) Locking pliers, adjustable jaw opening from 0 to 25mm



5031

Code

5031

4-PIECE MEASURING TOOL SETS

Includes:

- 1) Vernier caliper, range 0-150mm/0-6"
- 2) Outside micrometer, range 0-25mm, graduation 0.01mm (code **3202-25A**)
- 3) 90° beveled edge square, 100x70mm, grade 0 (code **4790-1000**)
- 4) Steel rule, 150mm/6" (code **7110-150**)

Code	Remark
5041	Vernier caliper, graduation 0.05mm/1/128" (code 1205-150S)
5041-2	Vernier caliper, graduation 0.02mm/0.001" (code 1205-1502S)



5041

4-PIECE MEASURING TOOL SET

Includes:

- 1) Digital caliper, range 0-150mm/0-6", resolution 0.01mm/0.0005" (code **1108-150**)
- 2) Outside micrometer, range 0-25mm, graduation 0.01mm, (code **3202-25A**)
- 3) 90° beveled edge square, 100x70mm, grade 0 (code **4790-1000**)
- 4) Steel rule, 150mm/6" (code **7110-150**)

Code

5042



5042

5-PIECE MEASURING TOOL SET

Includes:

- 1) Digital caliper, range 0-150mm/0-6", resolution 0.01mm/0.0005", (code **1108-150**)
- 2) Outside micrometer, range 0-25mm, graduation 0.01mm (code **3203-25A**)
- 3) Dial indicator, range 10mm, graduation 0.01mm (code **2308-10A**)
- 4) Magnetic stand (code **6201-60**)
- 5) Micrometer stand (code **6300**)

Code

5051



5051

5-PIECE MEASURING TOOL SET

- Includes:
 - 1) Digital caliper, range 0-150mm/0-6", resolution 0.01mm/0.0005" (code **1108-150**)
 - 2) Digital outside micrometer, range 0-25mm/0-1", resolution 0.001mm/0.00005" (code **3109-25B**)
 - 3) Digital indicator, range 12.7mm/0.5", resolution 0.01mm/0.0005" (code **2112-10**)
 - 4) Magnetic stand (code **6201-60**)
 - 5) Micrometer stand (code **6300**)

Code
5052



5052

6-PIECE MEASURING TOOL SET

- Includes:
 - 1) Digital caliper, range 0-150mm/0-6", resolution 0.01mm/0.0005" (code **1108-150**)
 - 2) Outside micrometer, range 0-25mm, graduation 0.01mm (code **3202-25A**)
 - 3) Dial indicator, range 10mm, graduation 0.01mm (code **2308-10FA**)
 - 4) 90° beveled edge square, 100x70mm, grade 0 (code **4790-1000**)
 - 5) Scriber (code **7230**)
 - 6) Steel rule, 150mm/6" (code **7110-150**)

Code
5061



5061

6-PIECE MEASURING TOOL SET

- Includes:
 - 1) Digital caliper, range 0-150mm/0-6" resolution 0.01mm/0.0005" (code **1108-150**)
 - 2) Outside micrometer, range 0-25mm graduation 0.01mm (code **3202-25A**)
 - 3) 90° beveled edge square, 100x70mm grade 00 (code **4790-0100**)
 - 4) Straight edge, 100mm (code **4700-100**)
 - 5) Spring divider, 150mm (code **7260-150**)
 - 6) Steel rule, 200mm/8" (code **7110-200**)

Code
5062



5062

6-PIECE MEASURING TOOL SETS

■ Includes:

- 1) Vernier caliper, range 0-150mm/0-6"
- 2) Outside micrometer, range 0-25mm graduation 0.01mm (code **3202-25A**)
- 3) 90° beveled edge square, 100x70mm grade 00 (code **4790-0100**)
- 4) Straight edge, 100mm (code **4700-100**)
- 5) Spring divider, 150mm (code **7260-150**)
- 6) Steel rule, 200mm/8" (code **7110-200**)

Code	Remark
5063	Vernier caliper, graduation 0.05mm/1/128" (code 1205-150S)
5063-2	Vernier caliper, graduation 0.02mm/0.001" (code 1205-1502S)



5063

9-PIECE MEASURING TOOL SET

■ Includes:

- 1) Digital caliper, range 0-150mm/0-6", resolution 0.01mm/0.0005" (code **1108-150**)
- 2) Outside micrometer, range 0-25mm, graduation 0.01mm (code **3202-25A**)
- 3) Protractor, range 0-180°, graduation 1° (code **4799-180**)
- 4) Pitch gauge, range 0.25-7mm, 24pcs, metric 60° thread (code **4820-124**)
- 5) Radius gauge, range 1-7mm (code **4801-17**)
- 6) Feeler gauge, range 0.05-1.00mm, 20pcs (code **4602-20**)
- 7) 90° beveled edge square, 100x70mm, grade 0 (code **4790-1000**)
- 8) Scriber (code **7230**)
- 9) Steel rule, 150mm/6" (code **7110-150**)

Code
5091



5091

13-PIECE MEASURING TOOL SET

■ Includes:

- 1) Digital caliper, range 0-150mm/0-6", resolution 0.01mm/0.0005", (code **1108-150**)
- 2) Outside micrometer, range 0-25mm, graduation 0.01mm (code **3202-25A**)
- 3) Dial indicator, range 10mm, graduation 0.01mm (code **2308-10A**)
- 4) Magnetic stand (code **6201-60**)
- 5) Protractor, range 0-180°, graduation 1° (code **4799-180**)
- 6) Pitch gauge, range 0.25-7mm, 24pcs, metric 60° thread (code **4820-124**)
- 7) Radius gauge, range 1-7mm (code **4801-17**)
- 8) Feeler gauge, range 0.05-1.00mm, 20pcs (code **4602-20**)
- 9) 90° beveled edge square, 100x70mm, grade 0 (code **4790-1000**)
- 10) Scriber (code **7230**)
- 11) Steel rule, 150mm/6" (code **7110-150**)
- 12) Depth base attachment (code **6140**)
- 13) Zero setting bar

Code
5013



5013

GRANITE SURFACE PLATES



CUSTOM-MADE
SUPPLY SPECIAL SIZES ACCORDING
TO CUSTOMER'S REQUEST



VIDEO



6900-132

- Made of granite, free from deterioration or dimensional change over time, minimal changes in dimension due to temperature changes
- Meet DIN876, grade 00 is for inspection room or lab, grade 0 is for workshop
- Optional accessory: stand for granite surface plate (code **6902**), jack for granite surface plate (code **6903**)

Grade 00

Code	Size (LxWxH)	Flatness	Weight (Kg)	Load (Kg)
6900-132*	300x200x60mm	2.7µm	11	30
6900-142*	400x250x60mm	2.9µm	18	50
6900-144*	400x400x60mm	3.1µm	29	60
6900-153*	500x315x70mm	3.2µm	33	60
6900-164*	630x400x80mm	3.5µm	60	65
6900-166*	630x630x100mm	3.8µm	119	75
6900-185*	800x500x100mm	3.9µm	120	100
6900-1106*	1000x630x140mm	4.4µm	265	200
6900-1101*	1000x1000x150mm	4.8µm	450	400
6900-1128*	1200x800x160mm	4.9µm	461	500
6900-1161*	1600x1000x180mm	5.8µm	864	600
6900-1201*	2000x1000x220mm	6.5µm	1320	650
6900-1202*	2000x1500x250mm	7.0µm	2250	750

Grade 0

Code	Size (LxWxH)	Flatness	Weight (Kg)	Load (Kg)
6900-032*	300x200x60mm	5.4µm	11	60
6900-042*	400x250x60mm	5.9µm	18	100
6900-044*	400x400x60mm	6.3µm	29	120
6900-053*	500x315x70mm	6.4µm	33	120
6900-064*	630x400x80mm	7.0µm	60	130
6900-066*	630x630x100mm	7.6µm	119	150
6900-085*	800x500x100mm	7.8µm	120	200
6900-0106*	1000x630x140mm	8.7µm	265	400
6900-0101*	1000x1000x150mm	9.7µm	450	800
6900-0128*	1200x800x160mm	9.8µm	461	1000
6900-0161*	1600x1000x180mm	11.5µm	864	1200
6900-0201*	2000x1000x220mm	12.9µm	1320	1300
6900-0202*	2000x1500x250mm	14.0µm	2250	1500

* Supplied with manufacturer inspection certificate



VIDEO

STANDS FOR GRANITE SURFACE PLATES

- For medium size granite surface plates
- 5 jacks are included
- Adjusting range of jacks: 25mm
- One foot on the bottom is adjustable

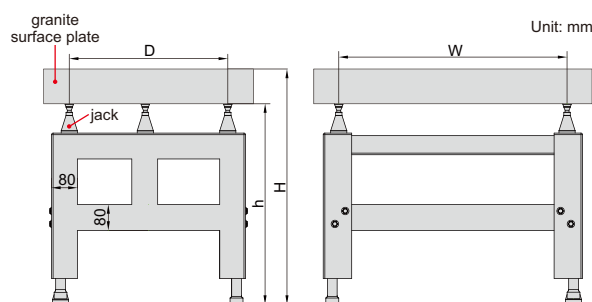

6902-64A

adjustable foot

Low stands

Code	For granite surface plate	W	D	H (with granite surface plate)	h (without granite surface plate)
6902-64A	630x400x80mm (code 6900-064 and 6900-164)	352	224	775-800	695-720
6902-66A	630x630x100mm (code 6900-066 and 6900-166)	352	352	775-800	675-700
6902-85A	800x500x100mm (code 6900-085 and 6900-185)	448	280	775-800	675-700
6902-106A	1000x630x140mm (code 6900-0106 and 6900-1106)	560	352	755-780	615-640
6902-101A	1000x1000x150mm (code 6900-0101 and 6900-1101)	560	560	755-780	605-630
6902-128A	1200x800x160mm (code 6900-0128 and 6900-1128)	672	448	755-780	595-620
6902-161A	1600x1000x180mm (code 6900-0161 and 6900-1161)	896	560	755-780	575-600

(mm)

High stands

Code	For granite surface plate	W	D	H (with granite surface plate)	h (without granite surface plate)
6902-64H	630x400x80mm (code 6900-064 and 6900-164)	352	224	1000-1025	920-945
6902-66H	630x630x100mm (code 6900-066 and 6900-166)	352	352	1000-1025	900-925
6902-85H	800x500x100mm (code 6900-085 and 6900-185)	448	280	1000-1025	900-925
6902-106H	1000x630x140mm (code 6900-0106 and 6900-1106)	560	352	1000-1025	860-885
6902-101H	1000x1000x150mm (code 6900-0101 and 6900-1101)	560	560	1000-1025	850-875
6902-128H	1200x800x160mm (code 6900-0128 and 6900-1128)	672	448	1000-1025	840-865
6902-161H	1600x1000x180mm (code 6900-0161 and 6900-1161)	896	560	1000-1025	820-845

(mm)

JACK SET FOR GRANITE SURFACE PLATES

- 5 jacks per set
- Adjustable height
- For large granite surface plates:
2000x1000x220mm
(code **6900-0201** and **6900-1201**)
2000x1500x250mm
(code **6900-0202** and **6900-1202**)

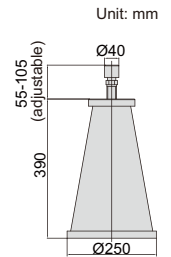

Code

6903-B

6903-B

MAGNETIC RECTANGULAR BLOCKS

HARDENED SURFACES

HIGH PRECISION

STRONG MAGNETIC FORCE

- For grinding, light milling, drilling and inspection of round and square jobs
- Hardened, high accuracy, strong magnetic force
- Working surfaces are hardened to HRC58-62
- Magnetic force on top, bottom and back sides
- Supplied in matched pair

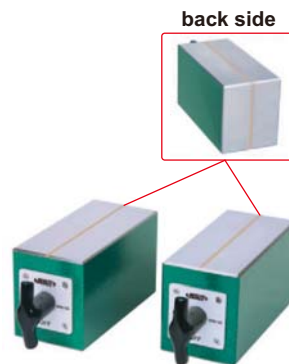

6898-150

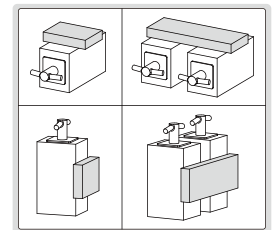
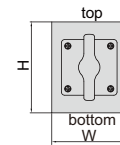

Code	Size (LxWxH)	Magnetic force	Parallelism of top to bottom side	Squareness of top and bottom to back side	Height difference of a matched pair
6898-100	100x70x70mm	100kgf	5µm	5µm	5µm
6898-150	150x70x85mm	125kgf	5µm	5µm	5µm

V-BLOCK SETS

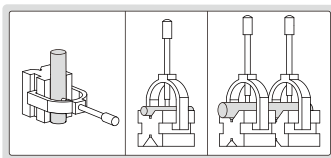

- Hold cylindrical workpieces for inspection and machining
- Two V-blocks per set
- Made of alloy steel
- Hardened to HRC60±2
- V groove on the top for large shafts
- V groove on the bottom for small shafts (except **6896-10**)



6896-10

6896-11

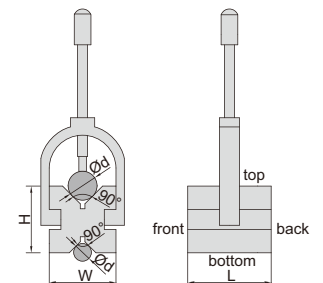

Code	Size (LxWxH)	Range of shafts (Ød)	Parallelism of both V grooves to top and bottom sides	Squareness of both V grooves to front and back sides	Height difference of a matched pair
6896-10	25x20x20mm	3-20mm	3µm	3µm	3µm
6896-11	50x40x40mm	5-30mm	5µm	5µm	5µm
6896-12	80x63x63mm	7-63mm	5µm	5µm	5µm
6896-13	100x80x80mm	7-80mm	5µm	5µm	5µm
6896-14	70x140x140mm	9-140mm	5µm	5µm	5µm

SIDE LIE-DOWN USE IS POSSIBLE

V-BLOCK SET

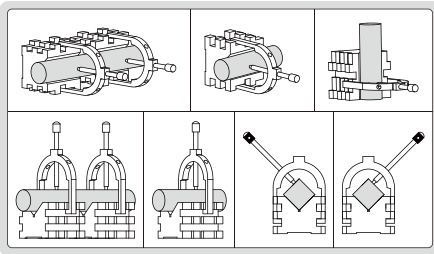

6802-1

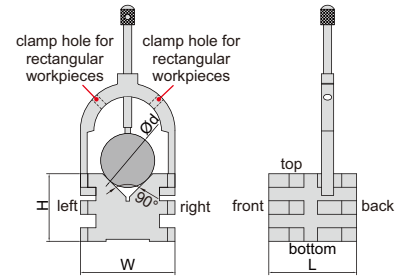

- Hold cylindrical or rectangular workpieces for inspection and machining
- Two V-blocks per set
- Made of alloy steel
- Hardened to HRC60±2
- Applicable for cylinder with diameter (Ød): 5-50mm
- Applicable for rectangular workpieces with thickness: ≤35mm

Code	Size (LxWxH)	Parallelism of V groove to top, bottom, left, right sides	Squareness of V groove to front and back sides	Height difference of a matched pair
6802-1	65x70x50mm	5µm	5µm	5µm

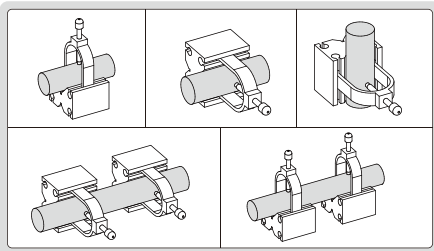

side lie-down use is possible



V-BLOCK SETS

SIDE LIE-DOWN USE IS POSSIBLE



6803-1

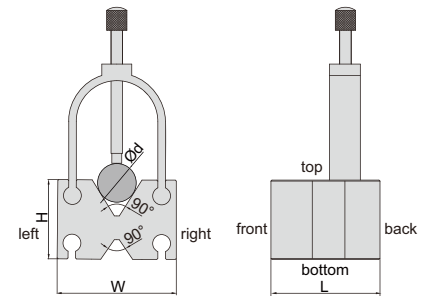

- Hold cylindrical workpieces for inspection and machining
- Two V-blocks per set
- Made of alloy steel
- Hardened to HRC60±2
- V groove on the top for large shafts
- V groove on the bottom for small shafts

Code	Size (LxWxH)	Range of shafts (Ød)	Parallelism of both V grooves to top, bottom, left, right sides	Squareness of both V grooves to front and back sides	Height difference of a matched pair
6803-1	25x20x20mm	4-35mm	5µm	5µm	5µm
6803-2	50x40x40mm	4-47mm	5µm	5µm	5µm

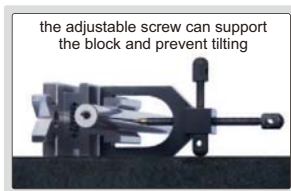

the adjustable screw can support the block and prevent tilting



side groove is for shouldered studs and pins



6804-M2

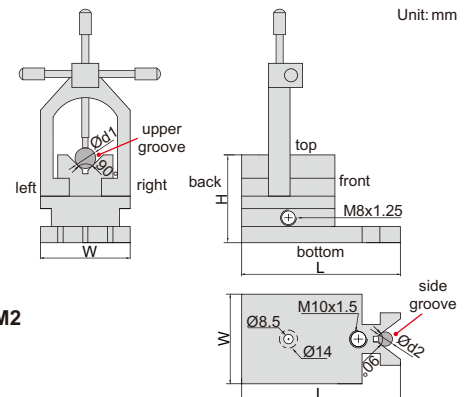

- Hold cylindrical workpieces for inspection and machining
- Made of alloy steel
- Hardened to HRC60±2

Code	Size (LxWxH)	Range of shafts (Ød1 and Ød2)	Parallelism of upper groove to bottom, left and right sides	Squareness of upper groove to back side	Parallelism of side groove to back side
6804-M2	90x48x48mm	5-33mm	5µm	5µm	5µm

V-BLOCK SETS

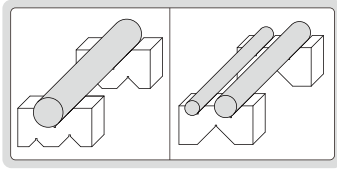

6887-3

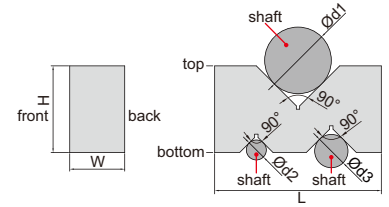

- Two V-blocks per set
- Made of hardened tool steel

(mm)

Code	Size (LxWxH)	Range of shafts (Ød1)	Range of shafts (Ød2)	Range of shafts (Ød3)
6887-1	50x19x24	3-32	3-16	3-22
6887-2	75x24x35	3-50	3-20	3-32
6887-3	100x33x52	3-68	3-26	3-40
6887-4	125x44x69	3-87	3-34	3-50

Code	Parallelism of three V grooves to top and bottom sides	Height difference of a matched pair
6887-1	5µm	5µm
6887-2	5µm	5µm
6887-3	5µm	5µm
6887-4	5µm	5µm

ROLLER BEARING V-BLOCK SETS

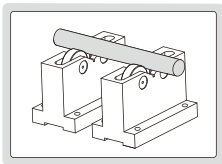

6888-1

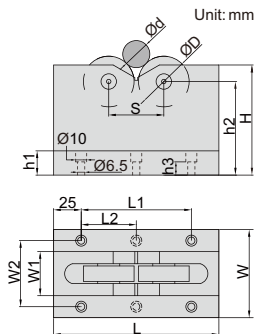

- Two V-blocks per set
- Workpieces don't get damaged due to bearings
- Suitable for heavy workpieces

Code	Size (LxWxH)	Diameter of bearings (ØD)	Range of shafts (Ød)	Parallelism of bearings to bottom	Load capacity
6888-1	150x60x100mm	42mm	25-70mm	12µm	500kg
6888-2	150x80x100mm	47mm	5-55mm	12µm	1000kg
6888-3	230x100x150mm	72mm	70-200mm	12µm	1000kg

Code	W1	W2	h1	h2	h3	L1	L2	S
6888-1	22	44	20	85	12	100	-	60
6888-2	40	60	22	85	12	100	-	50
6888-3	60	80	30	124	20	180	90	120

GRANITE V-BLOCK SETS

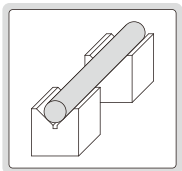

6897-1

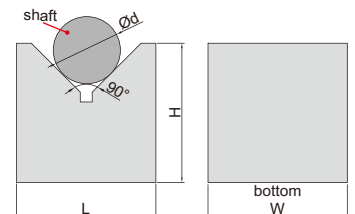

- Two V-blocks per set

Code	Size (LxWxH)	Range of shafts (Ød)	Parallelism of V groove to bottom	Height difference of a matchet pair
6897-1	70x50x70mm	6-75mm	4µm	5µm
6897-2	100x50x70mm	6-99mm	4µm	5µm

HARDENED SURFACES

HIGH PRECISION

STRONG MAGNETIC FORCE

MAGNETIC V-BLOCKS

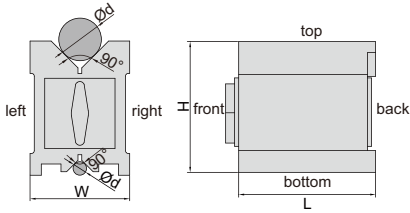

6889-11



6889-1

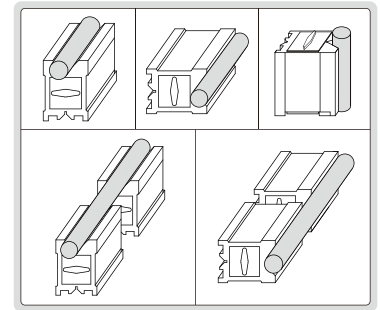

- Hardened, high accuracy, strong magnetic force, for grinding, light milling, drilling and inspection of round and square jobs
- All working surfaces are hardened to HRC60±2
- Magnetic force on top, bottom and two V grooves
- V groove on the top for large shafts
- V groove on the bottom for small shafts
- Suitable for cast iron surface plates and granite surface plates

Individual

Code	Size (LxWxH)	Range of shafts (Ød)	Magnetic force	Parallelism of V groove to top, bottom, left, right sides	Squareness of V groove to back side
6889-11	75x56x75mm	5-40mm	75kgf	5µm	5µm
6889-22	100x70x95mm	5-65mm	100kgf	5µm	5µm
6889-33	150x75x100mm	5-70mm	125kgf	5µm	5µm
6889-44	200x124x150mm	10-140mm	175kgf	10µm	10µm

Matched pair

Code	Size (LxWxH)	Range of shafts (Ød)	Magnetic force	Parallelism of V grooves to top, bottom, left, right sides	Squareness of V grooves to back side	Height difference of a matched pair
6889-1	75x56x75mm	5-40mm	75kgf	5µm	5µm	5µm
6889-2	100x70x95mm	5-65mm	100kgf	5µm	5µm	5µm
6889-3	150x75x100mm	5-70mm	125kgf	5µm	5µm	5µm
6889-4	200x124x150mm	10-140mm	175kgf	10µm	10µm	10µm

ATTENTION: NOT SUITABLE FOR STEEL OR IRON SURFACE

ATTENTION: NOT HARDENED

MAGNETIC V-BLOCK

- Hold cylindrical workpieces for inspection and machining
- Supplied in single piece
- Not hardened
- Not suitable for steel or iron surface

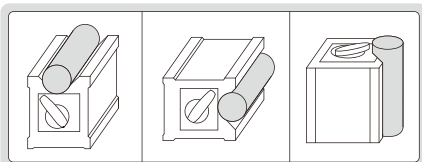

6890-702

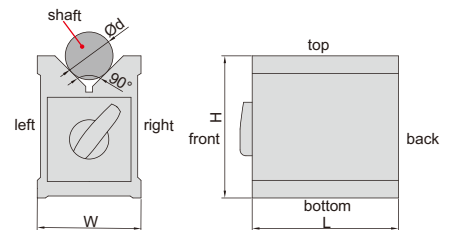

Code	Size (LxWxH)	Range of shafts (Ød)	Magnetic force	Parallelism of V groove to top, bottom, left and right sides	Squareness of V groove to back side
6890-702	70x60x73mm	6-44mm	56kgf	10µm	10µm

MAGNETIC V-BLOCKS

ATTENTION: NOT SUITABLE FOR STEEL OR IRON SURFACE

ATTENTION: NOT HARDENED

- Hold cylindrical workpieces for inspection and machining
- Supplied in single piece
- Not hardened
- V groove on the top for large shafts
- V groove on the bottom for small shafts
- Not suitable for steel or iron surface

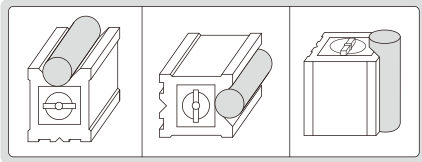

6801-1201

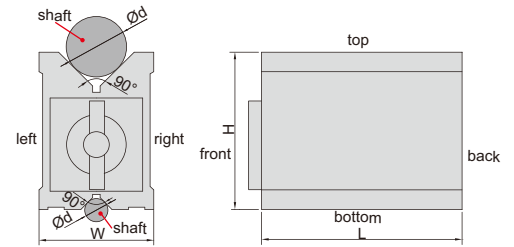

Code	Size (LxWxH)	Range of shafts (Ød)	Magnetic force	Parallelism of V grooves to top, bottom, left, right side	Squareness of V grooves to back side
6801-1201	80x70x95mm	6-67mm	64kgf	10µm	10µm
6801-1202	100x70x95mm	6-67mm	80kgf	10µm	10µm
6801-1203	120x70x95mm	6-67mm	96kgf	10µm	10µm

MAGNETIC V-BLOCK SETS

ATTENTION: LOW MAGNETIC FORCE

- Hold cylindrical workpieces for inspection, not suitable for machining due to low magnetic force
- Two V-blocks per set



6891-1

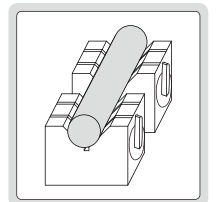
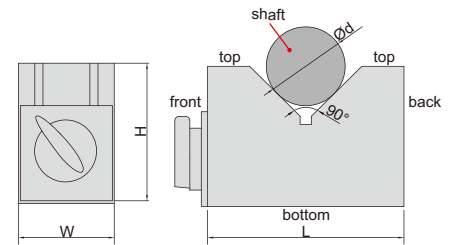

Code	Size (LxWxH)	Range of shafts (Ød)	Magnetic force	Parallelism of V groove to bottom and back sides	Height difference of a matched pair
6891-1	70x40x50mm	6-46mm	8kgf	10µm	10µm
6891-3	150x50x100mm	6-125mm	14kgf	10µm	10µm

MAGNETIC INDUCTION V-BLOCK

- Hold cylindrical workpieces for inspection and machining
- To be used on magnetic chucks
- Supplied in single piece
- V groove on the top for large shafts
- V groove on the bottom for small shafts



6892-1

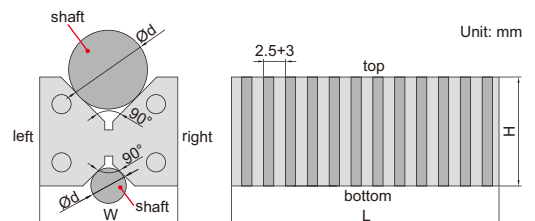
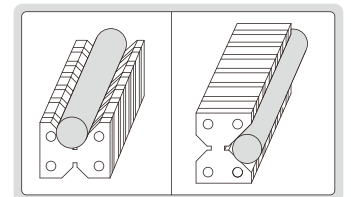

Code	Size (LxWxH)	Range of shafts (Ød)	Pole pitch	Parallelism of both V grooves to top, bottom, left, right sides
6892-1	110x60x48mm	6-50mm	2.5+3mm	10µm

MAGNETIC INDUCTION V-BLOCK SET

- Hold cylindrical workpieces for inspection and machining
- To be used on magnetic chucks
- Two V-blocks per set
- V groove on the top for large shafts
- V groove on the bottom for small shafts

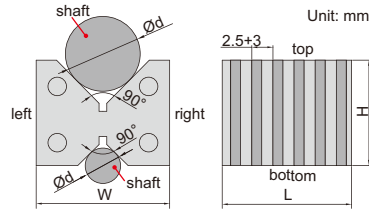

6899-1

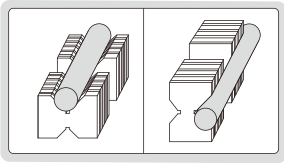

Code	Size (LxWxH)	Range of shafts (Ød)	Pole pitch	Parallelism of both V grooves to top, bottom, left and right sides	Height difference of a matched pair
6899-1	55x60x48mm	6-50mm	2.5+3mm	10µm	10µm

PARALLEL SETS

- Parallelism between top and bottom: 5µm
- Height difference of a matched pair: 5µm
- Made of alloy tool steel
- Hardened to HRC55-60

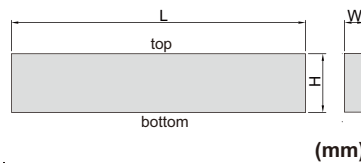

6533-144

Code	Parallels per set	Length (L)	Thickness (W)	Height (H)
6533-10	10 pairs	150	3	13, 16, 19, 22, 25, 28, 31, 35, 38, 41
6533-144	14 pairs	150	10	14, 16, 18, 20, 22, 24, 26, 28, 30, 32, 35, 40, 45, 50
6533-6	6 pairs	200	9.5	35, 40, 45, 50, 55, 58

PARALLEL SET

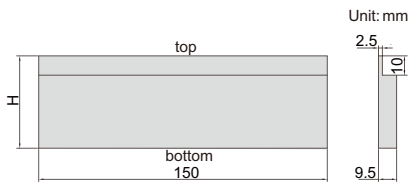

- Parallelism between top and bottom: 5µm
- Height difference of a matched pair: 5µm
- Made of alloy tool steel
- Hardened to HRC55-60

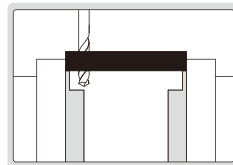

6534-6

Code	Parallels per set	Height (H)
6534-6	6 pairs	25, 30, 35, 40, 45, 48

MAGNETIC INDUCTION PARALLEL SETS

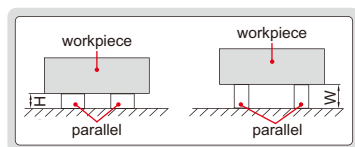

- To be used on magnetic chucks
- Two parallels per set

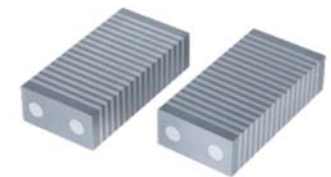
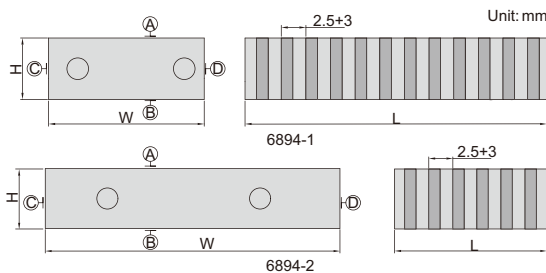

6894-1

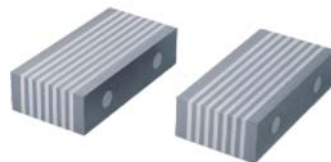

6894-2

Code	Size (LxWxH)	Pole pitch	Parallelism between A and B	Parallelism between C and D	Height difference of a matched pair
6894-1	100x50x25mm	2.5+3mm	10µm	10µm	10µm
6894-2	50x100x25mm	2.5+3mm	10µm	10µm	10µm

GRANITE PARALLEL SET



4143-250

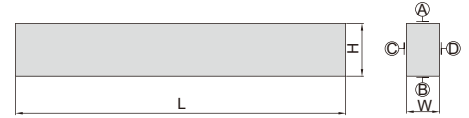
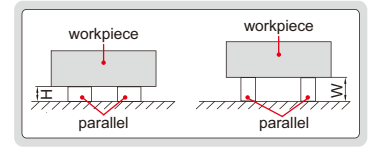

- Made of granite, hard and no rusty, no dimensional change over time or temperature change
- Two parallels per set

Code	Size (LxWxH)	Parallelism between A and B	Parallelism between C and D	Height difference of a matched pair
4143-250	250x25x40mm	3 μ m	3 μ m	3 μ m

ANGLE PLATE SETS



4003-12

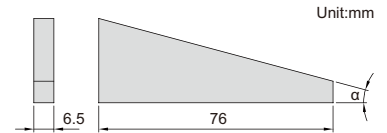

- For angle set-up in tooling, production and inspection
- Made of tool steel
- Hardness HRC55

Code	Angle plates included	Angle α	Accuracy
4003-10	10 pcs	1°, 2°, 3°, 4°, 5°, 10°, 15°, 20°, 25°, 30°	$\pm 9''$
4003-12	12 pcs	1/4°, 1/2°, 1°, 2°, 3°, 4°, 5°, 10°, 15°, 20°, 25°, 30°	$\pm 9''$

UNIVERSAL ANGLE PLATE SET



4004-9

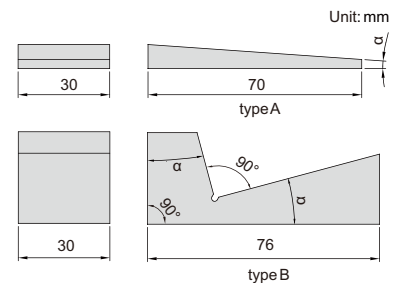

- For angle set-up in tooling, production and inspection
- Made of tool steel
- Hardness HRC55

Code	Angle plates included	Angle α	Type	Accuracy
4004-9	9 pcs	1/2°, 1°, 2°, 3°, 4°, 5°	typeA	$\pm 9''$
		10°, 15°, 30°	typeB	

ADJUSTABLE ANGLE BLOCKS



6535-30

- Made of hardened tool steel
- With locking screw
- Accuracy of angle: 10'

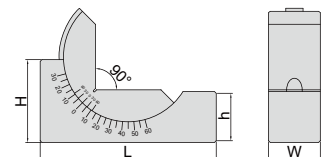

Code	Size (LxWxH)	h	Adjustable angle	Graduation of angle
6535-25	75x25x36mm	25mm	30°~0°~60°	10'
6535-30	102x30x49mm	30mm	30°~0°~60°	10'

RIGHT ANGLE PLATE

- Made of alloy steel
- Hardened to HRC60±2
- V groove for cylinders
- Parallelism and squareness between A, B, C, D, E, F, G and H: 6µm
- Parallelism and squareness of V groove to A, B, C, D, E, F, G and H: 6µm

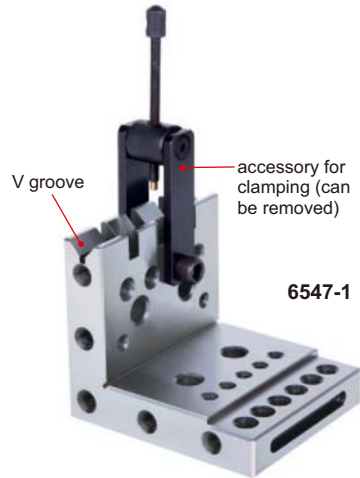

6547-1

Code	Size (LxWxH)
6547-1	100x100x115mm

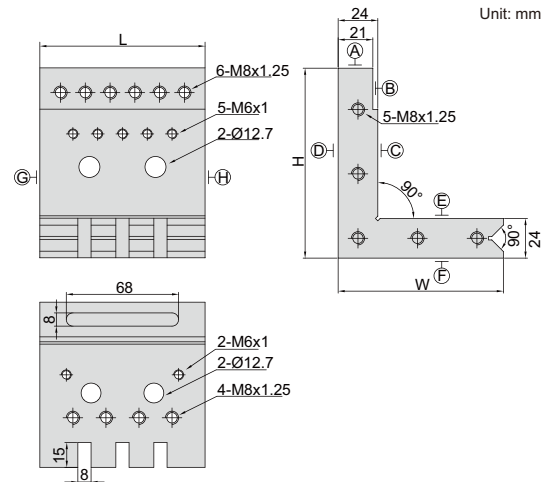

RIGHT ANGLE PLATE

- Made of tool steel
- Hardened to HRC60±2
- Squareness or parallelism between A, B, C and D: 5µm



6548-1

Code	Size (LxWxH)
6548-1	100x100x150mm

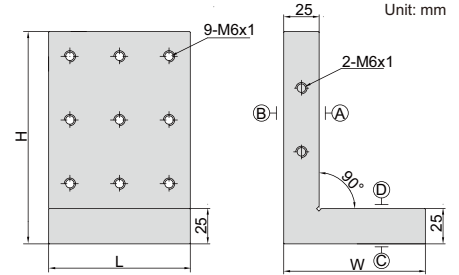

RIGHT ANGLE PLATE

- Made of tool steel
- Hardened to HRC56-58
- Parallelism between A, B, C, D, E and F: 3µm
- Squareness between A, B, C, D, E and F: 5µm



6549-1

Code	Size (LxWxH)
6549-1	150x63x150mm

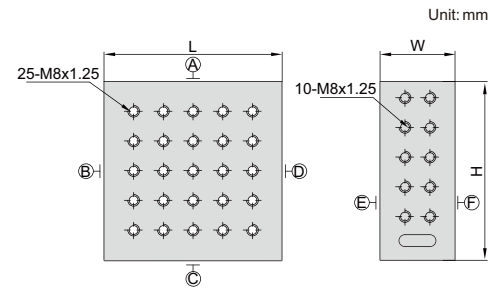

- Made of alloy tool steel

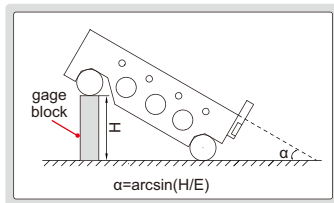

4155-100

SINE BARS

HIGH PRECISION

The front and back ends and two sides have mounting holes to install plate

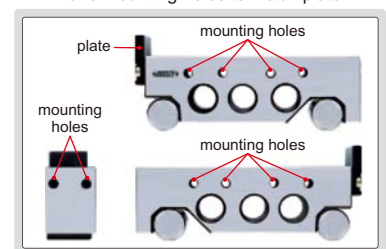

Code	Roller distance (E)	Table size (AxB)	C	Accuracy of α at 30°
4155-100	100	130x30	40	±5 seconds
4155-200	200	230x30	40	±5 seconds
4155-300	300	345x40	50	±8 seconds

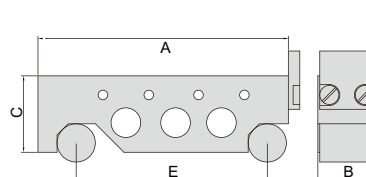

SINE TABLE



6527-100

- Accuracy of angle: $\pm 15''$
- Made of alloy tool steel
- Hardness HRC58-60

Code	Roller distance (E)	Table size (LxW)	Adjustable angle
6527-100	100mm	150x150mm	0-60°

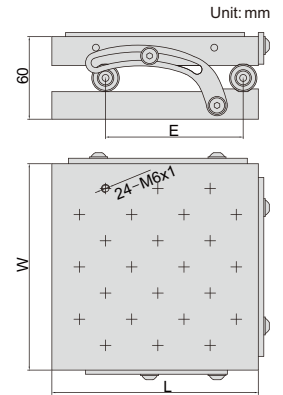

PRECISION SINE VISE

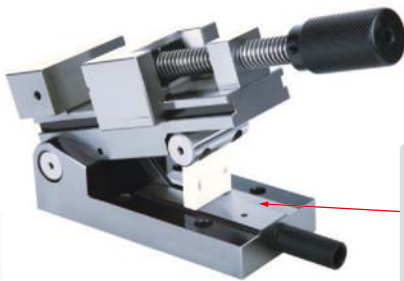

6522-80

There is a 1mm step (accuracy $\pm 0.002\text{mm}$). Gage blocks smaller than 0.5mm are not available. If small gage blocks are needed (for example, 0.25mm), a gage block 1.25mm can be used in order to make $1.25\text{mm} - 1\text{mm} = 0.25\text{mm}$.

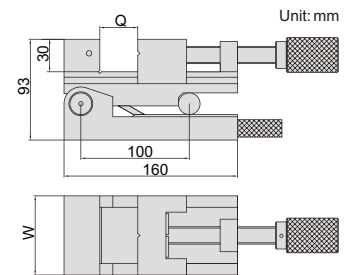
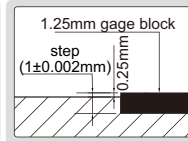

- Parallelism: $3\mu\text{m}/100\text{mm}$
- Squareness: $5\mu\text{m}/100\text{mm}$
- Accuracy of angle: $\pm 15''$
- Made of SKS tool steel, subzero treatment
- Hardness HRC58-60

Code	Jaw opening (Q)	Jaw width (W)	Adjustable angle
6522-80	0-80mm	73mm	0-46°

PRECISION SINE VISE

There is a 1mm step (accuracy $\pm 0.002\text{mm}$). Gage blocks smaller than 0.5mm are not available. If small gage blocks are needed (for example, 0.25mm), a gage block 1.25mm can be used in order to make $1.25\text{mm} - 1\text{mm} = 0.25\text{mm}$.

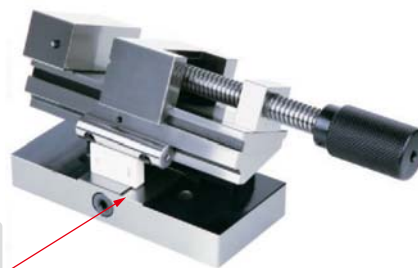
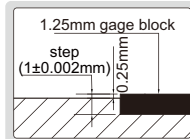

6523-80

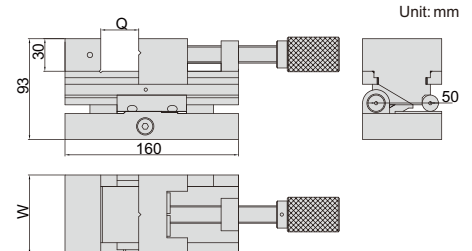

- Parallelism: $3\mu\text{m}/100\text{mm}$
- Squareness: $5\mu\text{m}/100\text{mm}$
- Accuracy of angle: $\pm 15''$
- Made of SKS tool steel, subzero treatment
- Hardness HRC58-60

Code	Jaw opening (Q)	Jaw width (W)	Adjustable angle
6523-80	0-80mm	73mm	0-46°

PRECISION COMPOUND SINE VISE

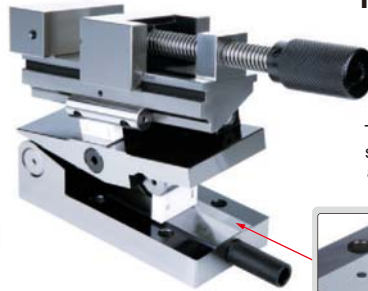
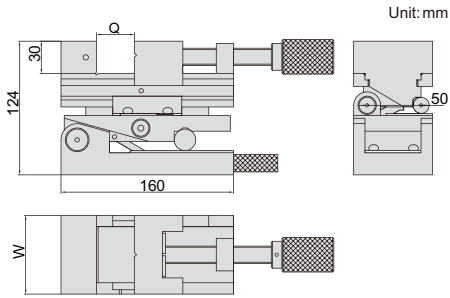

6524-80

There is a 1mm step (accuracy $\pm 0.002\text{mm}$). Gage blocks smaller than 0.5mm are not available. If small gage blocks are needed (for example, 0.25mm), a gage block 1.25mm can be used in order to make $1.25\text{mm} - 1\text{mm} = 0.25\text{mm}$.



- Parallelism: $3\mu\text{m}/100\text{mm}$
- Squareness: $5\mu\text{m}/100\text{mm}$
- Accuracy of angle: $\pm 15''$
- Made of SKS tool steel, subzero treatment
- Hardness HRC58-60

Code	Jaw opening (Q)	Jaw width (W)	Adjustable angle
6524-80	0-80mm	73mm	0-46°

PRECISION UNIVERSAL VISE

- Horizontal rotary: range 360° , graduation 0.05°
- Vertical incline: range 45° , graduation 0.05°
- With vertical incline adjust knob
- Parallelism and squareness between A, B, C and D: $5\mu\text{m}/100\text{mm}$, parallelism between D and E at 0° : $10\mu\text{m}/100\text{mm}$
- Made of tool steel
- Hardness HRC56-58

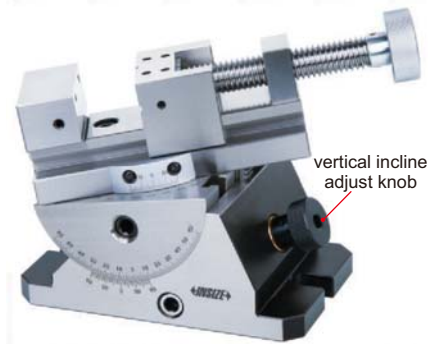
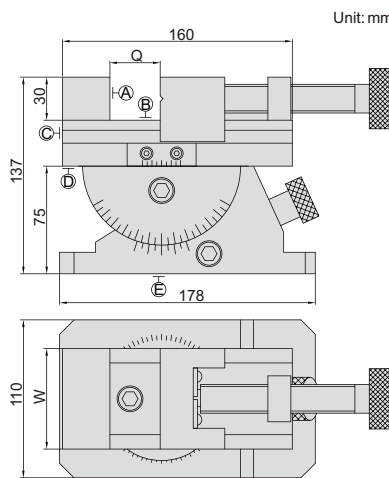

6521-80

Code	Jaw opening(Q)	Jaw width(W)
6521-80	0-80mm	70mm

PRECISION VISES

- Parallelism: $4\mu\text{m}/100\text{mm}$
- Squareness: $6\mu\text{m}/100\text{mm}$
- Made of SK2 tool steel
- Hardness HRC52-58

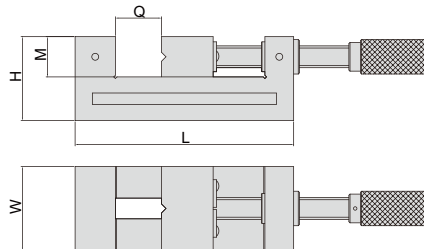

6525-76

Code	Jaw opening (Q)	Jaw width (W)	L	H	M
6525-73	0-73mm	63mm	176	63	30
6525-76	0-76mm	73mm	190	73	35
6525-120	0-120mm	98mm	255	82	40

PRECISION VISES

- Parallelism: $3\mu\text{m}/100\text{mm}$
- Squareness: $5\mu\text{m}/100\text{mm}$
- Made of SK2 tool steel
- Hardness HRC55-60

(mm)

Code	Jaw opening (Q)	Jaw width (W)	Overall length (L)	H	M
6526-80	0-80mm	50mm	150mm	53	25
6526-100	0-100mm	73mm	190mm	70	35

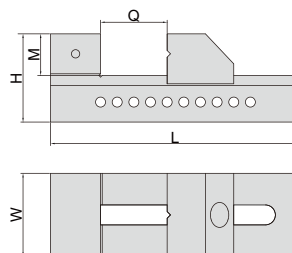

6526-80

3D TESTER



2842-3D

Code	Range	Graduation	Accuracy
2842-3D	1.5mm	0.01mm	0.01mm

Probe (optional) (mm)

Code	Name	L	D
2842-N1	standard probe	27	SØ3
2842-N2	long probe	62	SØ6

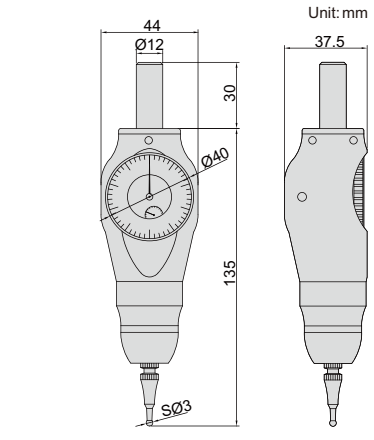

COMPACT DESIGN

ANTI MAGNETIC CARBIDE CONTACT POINT

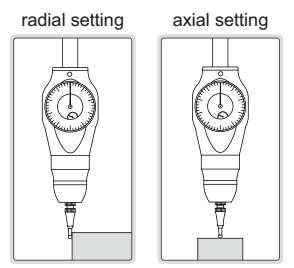

If probe tip is pressed too much, the probe breaks at the breaking point, in order to prevent damage of main body

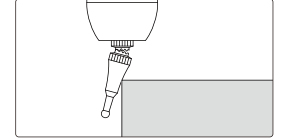

CENTERING INDICATOR

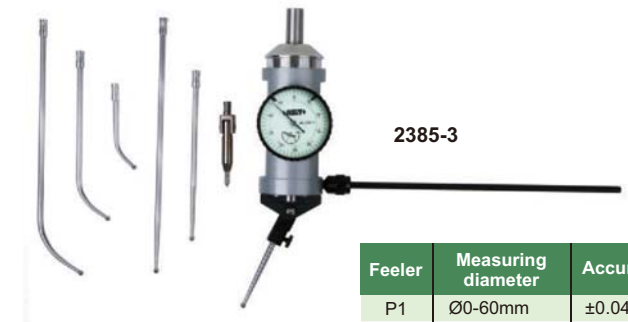

2385-3

Provides quick and accurate centering in boring and milling set-up

Code
2385-3

Feeler	Measuring diameter	Accuracy
P1	Ø0-60mm	±0.04mm
P2	Ø0-160mm	±0.06mm
P3	Ø0-250mm	±0.08mm
P4	Ø3.2-80mm	±0.04mm
P5	Ø3.2-180mm	±0.06mm
P6	Ø3.2-280mm	±0.08mm
P7	Ø0-2.8mm	±0.04mm

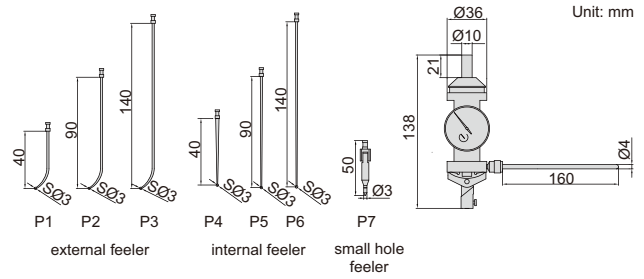
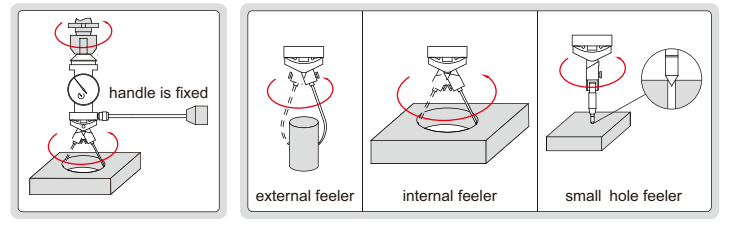

DIAL TEST INDICATOR CENTERING HOLDER

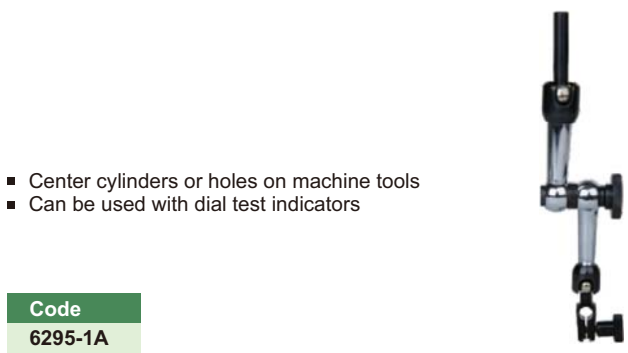

6295-1A

Center cylinders or holes on machine tools
Can be used with dial test indicators

Code
6295-1A

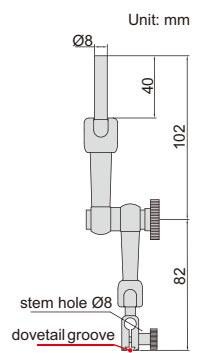

INDICATOR CENTERING HOLDER

- Center cylinders or holes on machine tools
- Can be used with dial test indicators or dial indicators

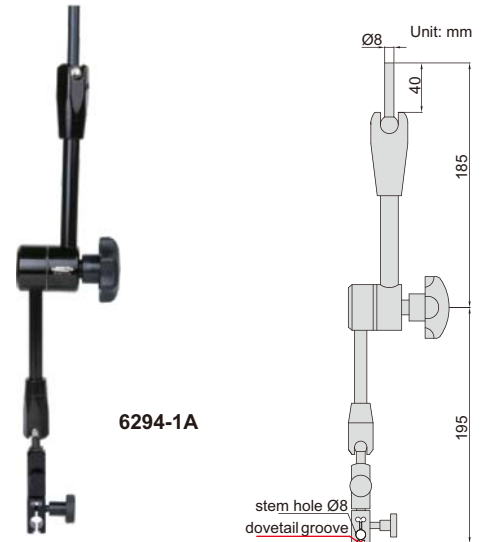

Code
6294-1A



3D ELECTRONIC EDGE FINDERS

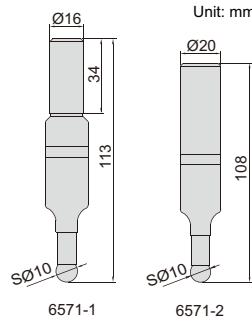
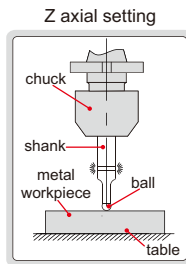
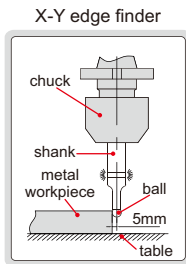
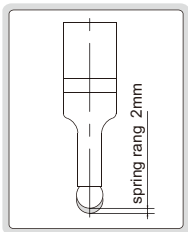

Code	Shank	Contact ball	Accuracy	Battery
6571-1	Ø16mm	SØ10mm	10µm	A23S, 12Vx1pc
6571-2	Ø20mm	SØ10mm	10µm	A23S, 12Vx1pc

- The shank is electrically conducted to the metal workpiece through the chuck and table, the LED lights up, when the ball touches the workpiece
- Not suitable for rotary use
- Hardened contact ball

ELECTRONIC EDGE FINDERS

- The shank is electrically conducted to the metal workpiece through the chuck and table, the LED lights up and the beeper sounds(only for 6566-3), when the ball touches the workpiece
- Not suitable for rotary use
- Hardened shank and contact ball

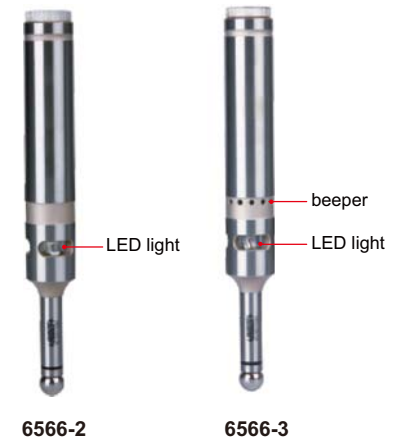
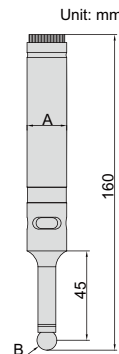
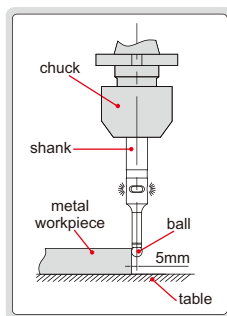

Code	Shank (A)	Contact ball (B)	Accuracy	Beeper	Battery
6566-2	Ø20mm	SØ10mm	5µm	without	23AE, 12Vx1pc
6566-3	Ø20mm	SØ10mm	5µm	with	23AE, 12Vx1pc

EDGE FINDER

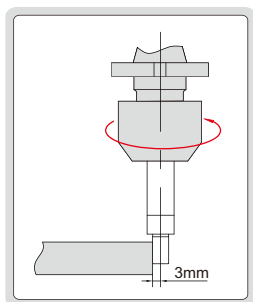

6567-1

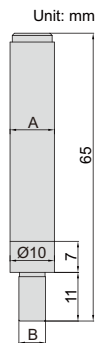

- Hardened shank and contact point

Code	Shank (A)	Contact point (B)	Accuracy
6567-1	Ø10mm	Ø6mm	8µm

EDGE FINDERS

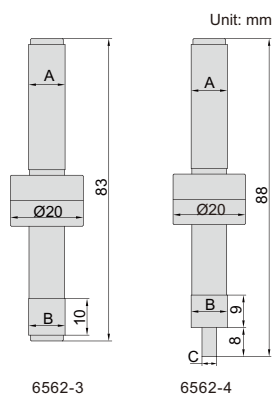

6562-3

6562-4



6562-3



6562-4

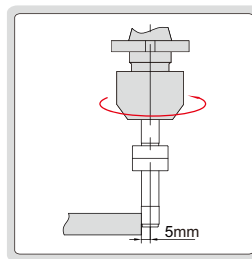

6562-3

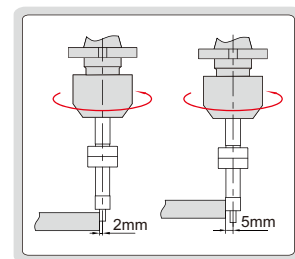

6562-4

- Hardened shank and contact point

Code	Shank (A)	Contact point (B)	Contact point (C)	Accuracy
6562-3	Ø10mm	Ø10mm	—	5µm
6562-4	Ø10mm	Ø10mm	Ø4mm	5µm

CERAMIC EDGE FINDER

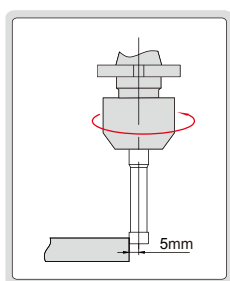

6568-1

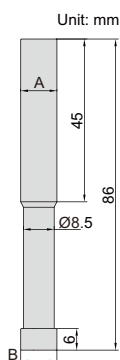

- Ceramic contact point, non magnetic

Code	Shank (A)	Contact point (B)	Accuracy
6568-1	Ø10mm	Ø10mm	8µm

ELECTRONIC ZERO SETTER

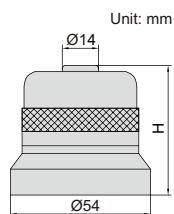

6550-50A

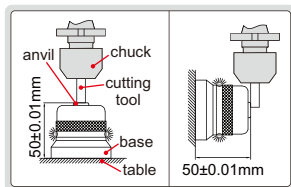

ATTENTION:
HIGH TEST FORCE

- The base is electrically conducted to the cutting tools through the table and chuck, the LED lights up when the cutting tool touches the anvil
- Magnetic base
- Battery LR44

Code	Height (H)	Accuracy	Test force
6550-50A	50mm	±10µm	27N (at 49mm)



LOW TEST FORCE

ELECTRONIC ZERO SETTER

- The base is electrically conducted to the cutting tools through the table and chuck, the LED lights up when the cutting tool touches the anvil
- Magnetic base
- Two batteries LR44

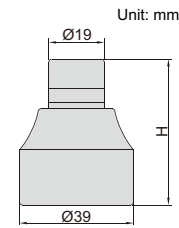
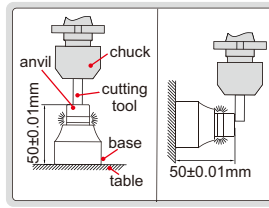
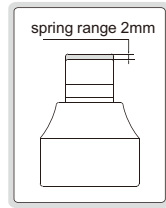

6553-50

Code	Height (H)	Accuracy	Test force
6553-50	50mm	±10µm	7N (at 49mm)



ZERO SETTER

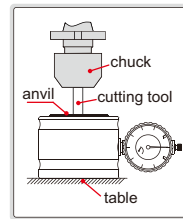
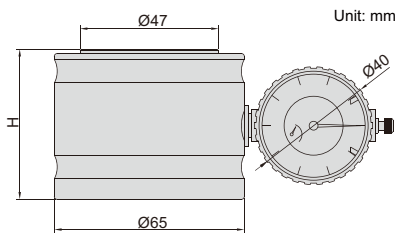

6554-50

Code	Height (H)	Accuracy	Test force
6554-50	50mm	±10µm	9N (at 50mm)

ZERO SETTER

- Magnetic base

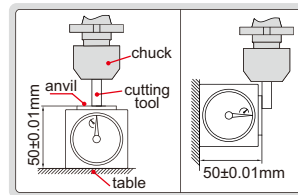
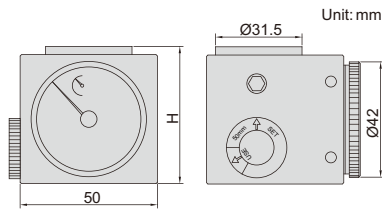

2397-502A

Code	Height (H)	Accuracy	Test force
2397-502A	50mm	±10µm	9N (at 50mm)

ZERO SETTER

- Magnetic base with on-off switch

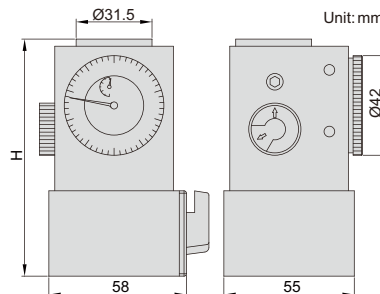
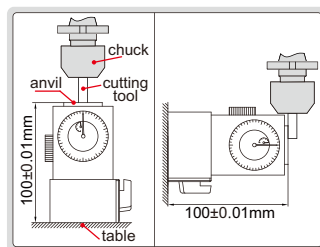

2394-100A

Code	Height (H)	Accuracy	Test force
2394-100A	100mm	±10µm	9N (at 100mm)

MEASURING DATA MANAGEMENT SOFTWARE

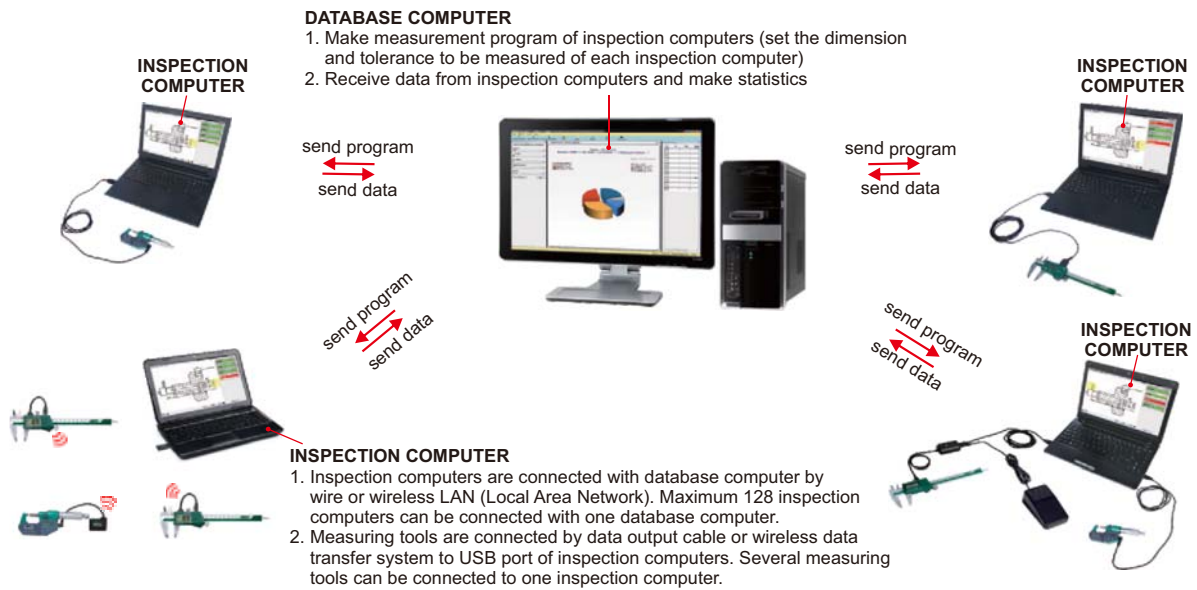

SOFTWARE FOR DATABASE COMPUTER CODE 7311-1

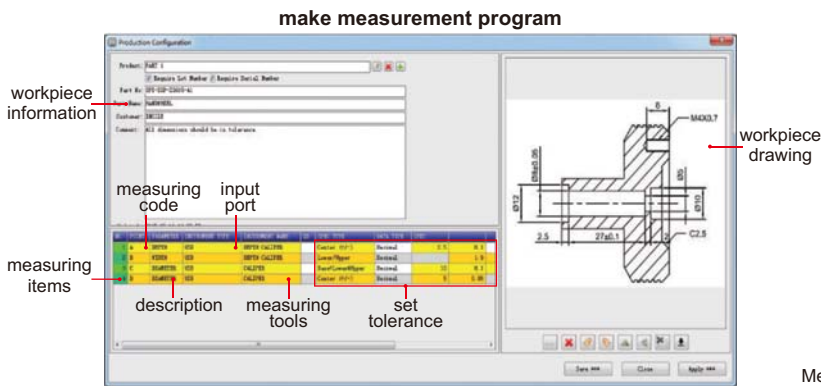

Make measurement program for each one inspection computer.
Maximum 200 dimensions can be measured by one inspection computer.

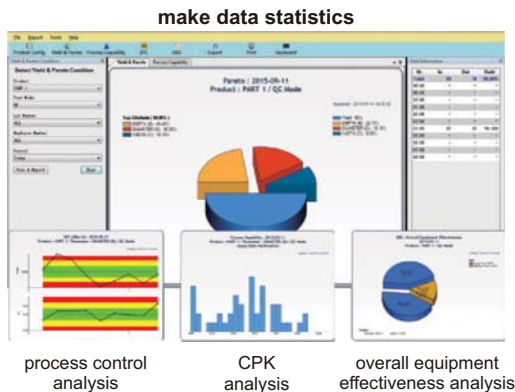

report

Item	Dimension	Value	Tolerance	Status
1	2.51	2.51	±0.05	OK
2	2.11	2.11	±0.05	OK
3	18.35	18.35	±0.1	OK
4	8.03	8.03	±0.05	OK

SOFTWARE FOR INSPECTION COMPUTER CODE 7311-2

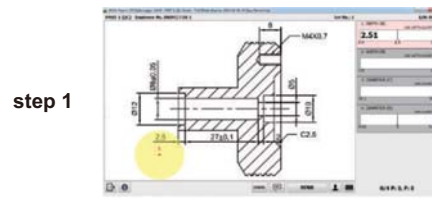

Measure the 1st dimension by following the yellow position indication.

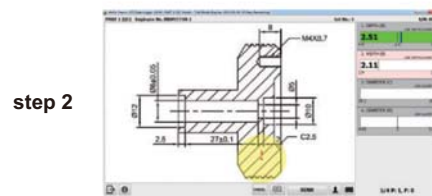

Measure the 2nd dimension by following the yellow position indication.
The 1st data will be shown in red or green according its tolerance.

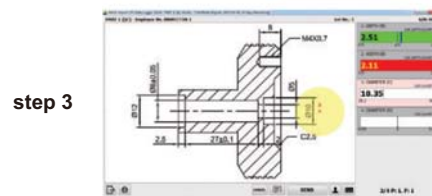

Measure the 3rd dimension by following the yellow position indication.
The 2nd data will be shown in red or green according its tolerance.

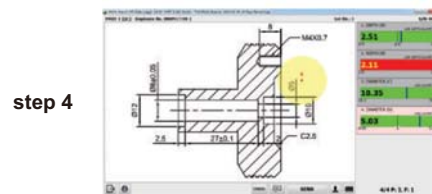

Measure the 4th dimension by following the yellow position indication.
The 3rd data will be shown in red or green according its tolerance.
The data of four measurements will be sent to the database computer.

Code	Description	Applicable products
7306-2	receiver	USB and RS232 connection ports, strong transmission signal, the maximum distance is 100m
7306-1	mini receiver	USB connection port, for short distance (within 20m) or barrier-free area
7306-20	transmitter	digital calipers, digital depth gages and digital height gages (not for 1103, 1150)
7306-30	transmitter	digital micrometers, digital three point internal micrometers (not for 3631, 3632, 3108, 3109, 3635)
7306-30A	transmitter	digital micrometers, digital three point internal micrometers (not for 3631, 3632, 3108, 3109, 3635)
7306-40	transmitter	digital indicators
		digital protractors

WIRELESS DATA TRANSFER SYSTEM



receiver
7306-2

APPLICABLE FOR
OTHER BRANDS



transmitter
7306-20



VIDEO



protecting cap
(optional)
code 7306-CAP

- CONNECTION: one receiver can be connected to 30 transmitters.



software CD
(included)



read
button

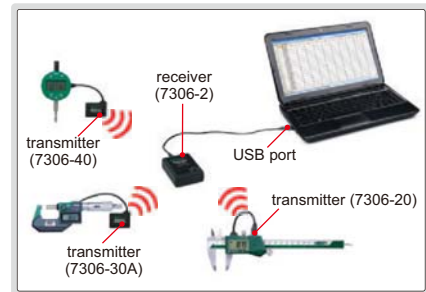

DATA COLLECTION:

- Single collection: press the read button once to collect the reading from measuring tool once.
- Multi collection: press the read button once to start collecting readings from measuring tools continuously, press the button again to stop collecting. Total collection times and interval time can be adjusted.

DISPLAY: data can be input to Excel as keyboard signal.

measuring tools code A, B, C

1	A	12.34
2	B	56.78
3	C	90.12
4	A	34.56
5	B	78.90
6	C	23.45
7	A	67.89
8	B	01.23
9	C	45.67
10	A	89.01
11	B	12.34
12	C	56.78
13	A	90.12
14	B	34.56
15	C	78.90
16	A	23.45
17	B	67.89
18	C	01.23
19	A	45.67
20	B	89.01
21	C	12.34
22	A	56.78
23	B	90.12
24	C	34.56
25	A	78.90
26	B	23.45
27	C	67.89
28	A	01.23
29	B	45.67
30	C	89.01

All data are displayed in the same column. Each measuring tool can be coded such as A, B, C, etc.

7302-SPC5A 7302-SPC5B 7302-SPC2A 7302-SPC6 7302-SPC3A 7302-SPC4



USB DATA OUTPUT CABLES



VIDEO



7304-2

- Connect to USB port of computer
- Without software, data can be input as keyboard signal to Excel, Word, etc.
- Press the red button or foot switch (optional) to input data

Code	Description	Remark
7302-SPC5A	cable (length 2.5m)	for digital calipers and digital depth gages (not for 1103)
7302-SPC5B	cable (length 2.5m)	for digital calipers and digital depth gages (not for 1103)
7302-SPC2A	cable (length 2.5m)	for digital micrometers (not for 3631, 3632, 3108, 3109, 3635)
7302-SPC6	cable (length 2.5m)	for digital micrometers (not for 3631, 3632, 3108, 3109, 3635)
7302-SPC3A	cable (length 2.5m)	for digital indicators
		digital protractors
7302-SPC4	cable (length 2.5m)	for digital calipers 1103 series (for 1103 only)
7304-2	foot switch with cable (length 1.5m)	optional

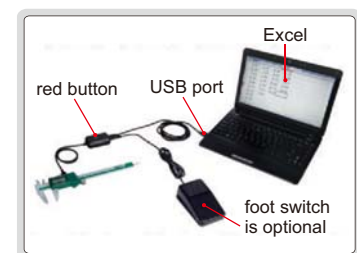

RS232 DATA OUTPUT CABLES



VIDEO
automatic judgment by setting tolerance

test result display (maximum value, minimum value, total quantity of workpiece, quantity of Go and No-Go, quantity of exceed upper tolerance and exceed lower tolerance)

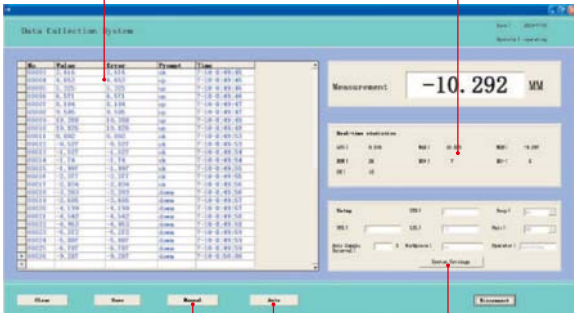

manual sampling automatic sampling set auto sampling interval and tolerance



7305-SPC1A



7305-SPC2A



USB power port

7305-SPC3



foot switch (optional)

7304-2

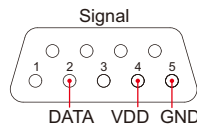

- Manual sampling and automatic sampling
- Press manual sampling button in software or red button on cable or foot switch once to collect the reading from measuring tool once
- Can be used in Windows Hyperterminal
- Supplied with software
- Voltage required: 5-10V
- Cable length 2.5m

Code	Applicable products
7305-SPC1A	digital indicators digital protractors
7305-SPC2A	digital calipers and digital depth gages (not for 1103)
7305-SPC3	digital micrometers (not for 3631, 3632, 3108, 3109, 3635)
7305-SPC3A	digital micrometers (not for 3631, 3632, 3108, 3109, 3635)
7304-2	foot switch with cable (length 1.5m), optional

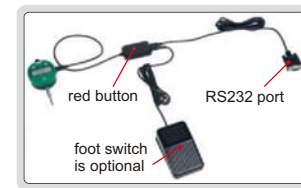

software CD (included)

DIGITAL HORIZONTAL SCALES

DATA OUTPUT



7101-300A



7101-400A

example of application

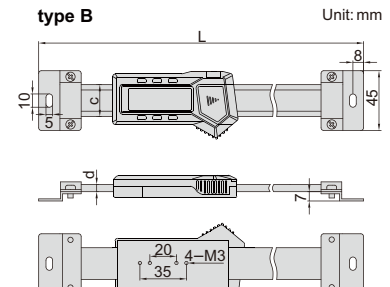
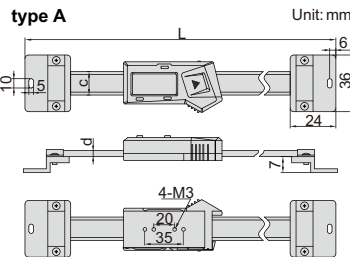
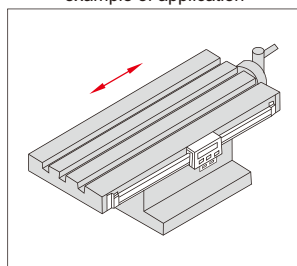
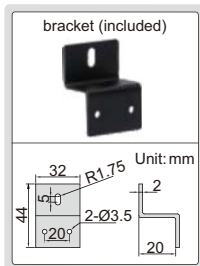

(mm)

Code	Range	Type	Accuracy	L	c	d
7101-100A	100mm	A	±0.02mm	215	16	4
7101-150A	150mm	A	±0.03mm	265	16	4
7101-200A	200mm	A	±0.03mm	315	16	4
7101-300A	300mm	A	±0.04mm	445	16	4
7101-400A	400mm	B	±0.05mm	590	24	5.5
7101-500A	500mm	B	±0.05mm	690	24	5.5
7101-600A	600mm	B	±0.08mm	790	24	5.5
7101-800A	800mm	B	±0.10mm	990	24	5.5
7101-1000A	1000mm	B	±0.10mm	1190	31	10.5

- Resolution: 0.01mm/0.0005"
- Buttons: on/off, zero, mm/inch
- Automatic power off, move the digital unit to turn on power
- Battery CR2032
- Data output
- Made of stainless steel
- Supplied with bracket to be mounted on the back
- Optional accessory: data output cable (code 7306-20, 7302-SPC5A/SPC5B, 7305-SPC2A)

- Resolution: 0.01mm/0.0005"
- Button function: on/off, zero, mm/inch, ABS, data preset
- Absolute and incremental measurement
- Battery CR2032
- Data output
- Made of stainless steel
- Supplied with bracket to be mounted on the back
- Optional accessory: data output cable (code 7306-20, 7302-SPC5A/SPC5B, 7305-SPC2A)

DATA OUTPUT

data output cable



7301-SPC5

DIGITAL VERTICAL SCALES

- Resolution: 0.01mm/0.0005"
- Buttons: on/off, zero, mm/inch, ABS/INC, data hold, TOL, set
- ABS/INC is for absolute and incremental measurement
- TOL is for tolerance measurement
- Battery LR44
- Data output
- Made of stainless steel
- Supplied with bracket to be mounted on the back
- Optional accessory: data output cable (code 7301-SPC5)

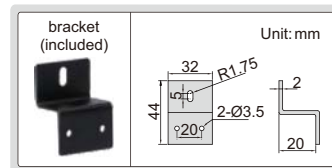
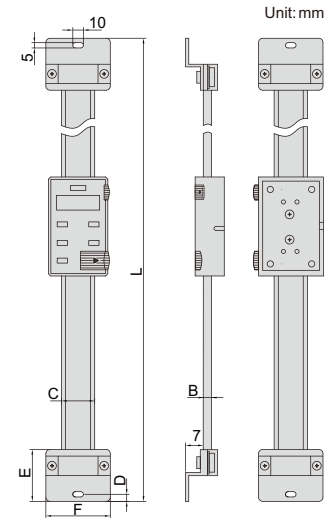
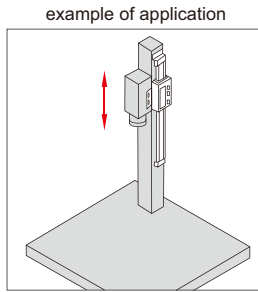

7102-300

Code	Range	Accuracy	B	C	D	E	F	L	(mm)
7102-100	100mm/4"	±0.02mm	4	20	6	24	40	245	
7102-150	150mm/6"	±0.03mm	4	20	6	24	40	296	
7102-200	200mm/8"	±0.03mm	4	20	6	24	40	345	
7102-300	300mm/12"	±0.04mm	4	20	6	24	40	445	
7102-400	400mm/16"	±0.05mm	4	20	6	24	40	545	
7102-500	500mm/20"	±0.05mm	5.5	24	8	32	45	685	
7102-600	600mm/24"	±0.08mm	5.5	24	8	32	45	785	
7102-800	800mm/32"	±0.10mm	5.5	24	8	32	45	985	
7102-1000	1000mm/40"	±0.10mm	5.5	24	8	32	45	1185	



COUNTERS

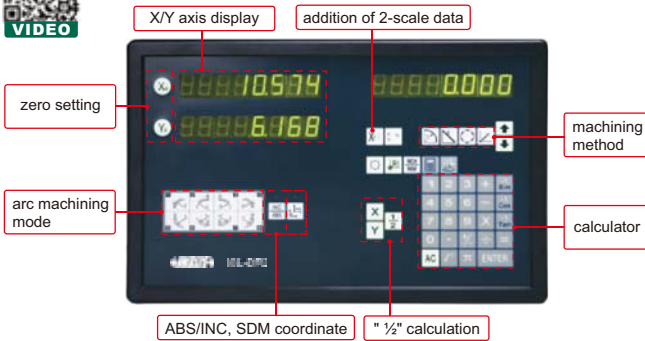

ISL-DR2

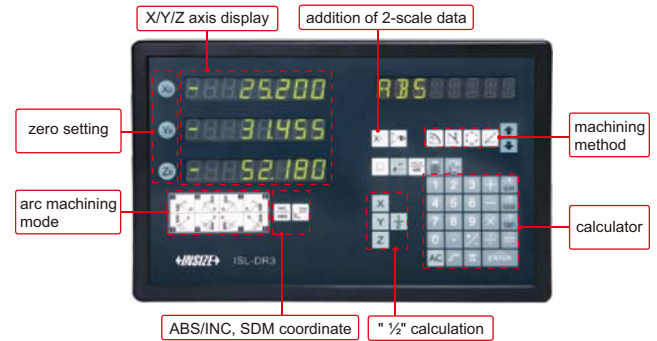

ISL-DR3

SPECIFICATION

Code	ISL-DR2	ISL-DR3
Application	two-axis	three-axis
Scale input ports	2	3
Resolution	0.05µm, 0.1µm, 0.2µm, 0.5µm, 1µm, 2µm, 5µm, 10µm, 20µm, 50µm	
Functions	addition of 2-scale data, linearity error compensation, smoothing, RS232C interface unit, BCD code out, zero setting, preset, resolution setting, counting direction setting, inch/mm conversion, ABS/INC conversion, expansion/contraction coefficient setting, "1/2" calculation, detecting RI, bolt-hole circle machining, ramp circle machining	
Power supply	110/220V, 50/60Hz	
Dimension	295×185×45mm	
Weight	1.45kg	

STANDARD DELIVERY

Main unit	1pc
Mounting bracket	1pc
Ground cable	1pc
RS232C cable	1pc
Software CD for RS232C	1pc



software CD (included)



mounting bracket (included)



LINEAR SCALES



ISL-A1-300

Series ISL-A1 and ISL-A5

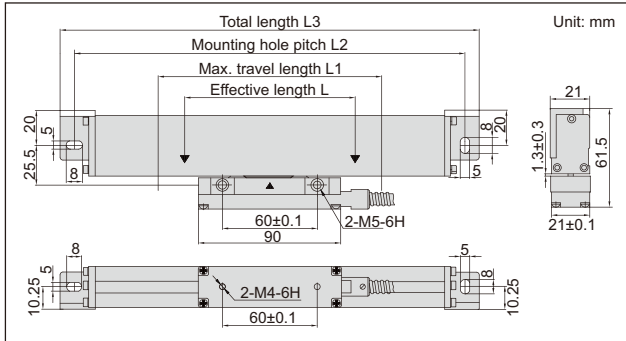

Series ISL-B5

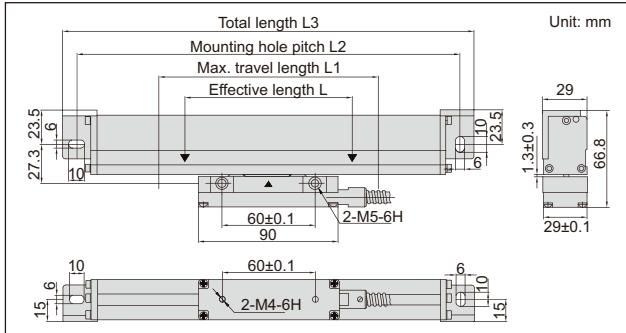

STANDARD DELIVERY

Main unit	1pc
'L' shape support	1pc
Anti-dust cover	1pc
Plain base	1pc (for L ≥ 1500mm)
Mounting accessories	1 package

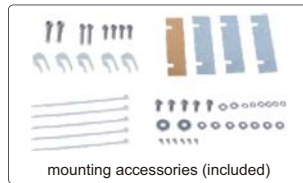
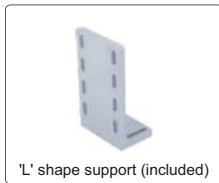

Effective length (L)	Code		
	Series ISL-A1	Series ISL-A5	Series ISL-B5
50mm	ISL-A1-50	ISL-A5-50	ISL-B5-50
100mm	ISL-A1-100	ISL-A5-100	ISL-B5-100
150mm	ISL-A1-150	ISL-A5-150	ISL-B5-150
200mm	ISL-A1-200	ISL-A5-200	ISL-B5-200
250mm	ISL-A1-250	ISL-A5-250	ISL-B5-250
300mm	ISL-A1-300	ISL-A5-300	ISL-B5-300
350mm	ISL-A1-350	ISL-A5-350	ISL-B5-350
400mm	ISL-A1-400	ISL-A5-400	ISL-B5-400
450mm	ISL-A1-450	ISL-A5-450	ISL-B5-450
500mm	ISL-A1-500	ISL-A5-500	ISL-B5-500
550mm	ISL-A1-550	ISL-A5-550	ISL-B5-550
600mm	ISL-A1-600	ISL-A5-600	ISL-B5-600
650mm	ISL-A1-650	ISL-A5-650	ISL-B5-650
700mm	ISL-A1-700	ISL-A5-700	ISL-B5-700
750mm	ISL-A1-750	ISL-A5-750	ISL-B5-750
800mm	ISL-A1-800	ISL-A5-800	ISL-B5-800
850mm	ISL-A1-850	ISL-A5-850	ISL-B5-850
900mm	ISL-A1-900	ISL-A5-900	ISL-B5-900
950mm	ISL-A1-950	ISL-A5-950	ISL-B5-950
1000mm	ISL-A1-1000	ISL-A5-1000	ISL-B5-1000
1100mm		ISL-A5-1100	ISL-B5-1100
1200mm			ISL-B5-1200
1300mm			ISL-B5-1300
1400mm			ISL-B5-1400
1500mm			ISL-B5-1500
1600mm			ISL-B5-1600
1700mm			ISL-B5-1700
1800mm			ISL-B5-1800
1900mm			ISL-B5-1900
2000mm			ISL-B5-2000
2100mm			ISL-B5-2100
2200mm			ISL-B5-2200
2300mm			ISL-B5-2300
2400mm			ISL-B5-2400
2500mm			ISL-B5-2500
2600mm			ISL-B5-2600
2700mm			ISL-B5-2700
2800mm			ISL-B5-2800
2900mm			ISL-B5-2900
3000mm			ISL-B5-3000
3100mm			ISL-B5-3100
3200mm			ISL-B5-3200

SPECIFICATION

Code	Series ISL-A1		Series ISL-A5		Series ISL-B5	
	L1 (mm)	L+30(L<950)	L+50(L≥ 950)	L+30(L<950)	L+50(L≥ 950)	L+30(L<950)
L2 (mm)	L+132(L<950)	L+152(L≥ 950)	L+132(L<950)	L+152(L≥ 950)	L+136(L<950)	L+156(L≥ 950)
L3 (mm)	L+149(L<950)	L+169(L≥ 950)	L+149(L<950)	L+169(L≥ 950)	L+154(L<950)	L+174(L≥ 950)
Resolution	1μm		5μm		5μm	
Max. response speed	50m/min		90m/min		60m/min	
Scale grating pitch	20μm					
Scale reference point pitch	50mm					
Accuracy	±(5+5L/1000)μm L is the effective length in mm					
Cable length	3.5m (L: 50-950mm), 5m (L: 1000-1500mm), 10m (L: 1600-3200mm)					

LINEAR GAGE
IP65
WATERPROOF

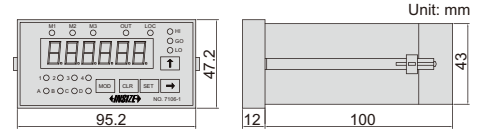
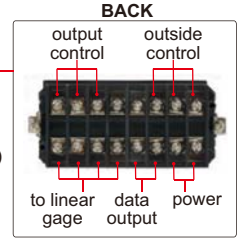
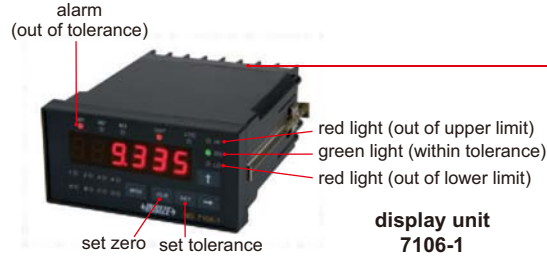
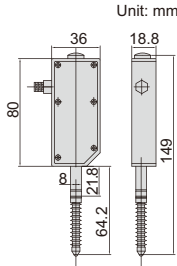

- Linear gage: shock-proof, water proof, dust proof, suitable for high speed movement, long working life
- Display unit: set tolerance and make judgment (out of upper limit, within tolerance, out of lower limit), output the judgment to control outside devices, set zero and hold reading from outside

LINEAR GAGE SPECIFICATION

Code	7106-11	7106-12
Measuring range	12mm	12mm
Resolution	0.01mm	0.001mm
Accuracy	20µm	5µm
Hysteresis	10µm	2µm
Measuring principle	capacity system	
Voltage	5V	
Sampling frequency	100 times/sec.	
Working life	ten million times	
Dust/waterproof	IP65	
Measuring force	1.5N	
Cable length	2m	
Data output	four-core wire	

DISPLAY UNIT SPECIFICATION

Code	7106-1
Display	6 digits
Quantity of linear gages to be connected	1pc
Tolerance	set tolerance and make judgment with alarm and lights (out of upper limit, within tolerance, out of lower limit)
Output control	output the tolerance judgment (out of upper tolerance, within tolerance, out of lower tolerance) to control outside devices
Outside control	control the display units from outside (set zero, hold reading)
Data output	connect to PC
Power supply	DC 9~24V

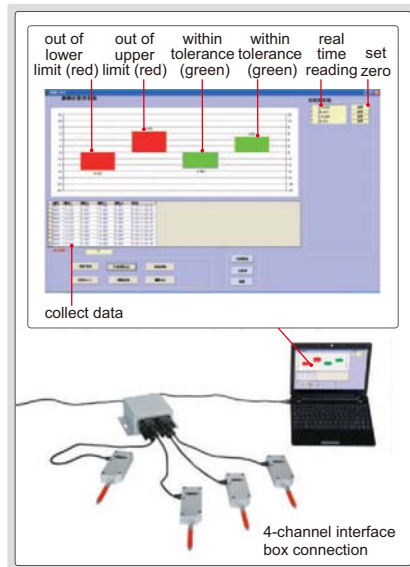

INTERFACE BOX SPECIFICATION

Code	7107-1	7107-2
Quantity of linear gages to be connected	4pcs	8pcs
Data port	RS232 and RS485	
Power supply	DC 9~24V	

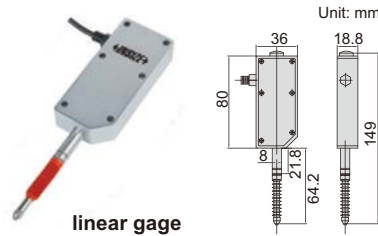

- Software is supplied with interface boxes. In the software, it is possible to set tolerance of each channel and show judgment (red when out of tolerance, green when within tolerance), set zero, collect data manually or automatically (time is adjustable), output data to Excel, print report

LINEAR GAGE SPECIFICATION

Code	7107-11	7107-12
Measuring range	12mm	12mm
Resolution	0.01mm	0.001mm
Accuracy	20µm	5µm
Hysteresis	10µm	2µm
Measuring principle	capacity system	
Voltage	5V	
Sampling frequency	100 times/sec.	
Working life	ten million times	
Dust/waterproof	IP65	
Measuring force	1.5N	
Cable length	2m	
Data output	RS232	

MULTI LINEAR GAGE SYSTEM

LINEAR GAGE
IP65
WATERPROOF



4-channel interface box
7107-1

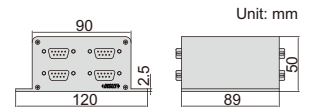

8-channel interface box
7107-2

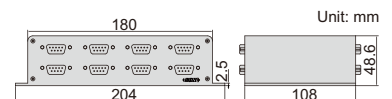

HIGH PRECISION LINEAR GAGES AND DISPLAY UNIT

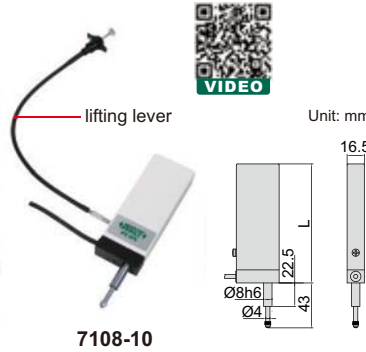
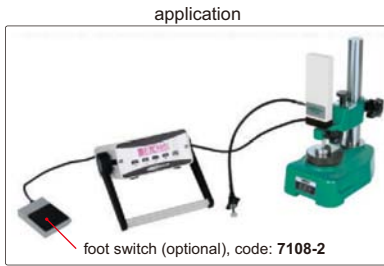

7108-10

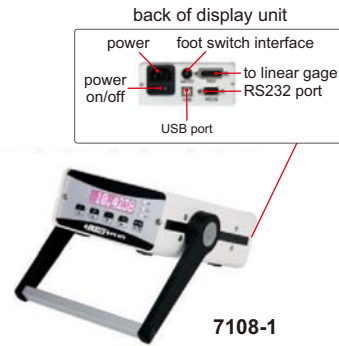

7108-1

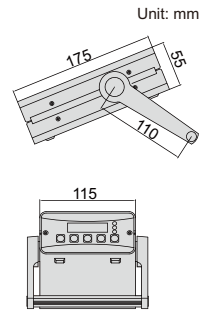

LINEAR GAGE SPECIFICATION

Code	7108-10	7108-30
Measuring range	10mm	30mm
Resolution	0.01µm	
Accuracy	(0.5+L/60)µm, L is measuring length in mm	
Dust/waterproof	IP50	
Output signal	1Vss	
Grating pitch	8µm	
Measuring force	0.7~1.6N	
Cable length	1.5m	
Linear gage length (L)	113.5mm	133.5mm

DISPLAY UNIT SPECIFICATION

Code	7108-1
Display	8 digits
Character height	9mm
Quantity of linear gages to be connected	single channel, to connect one linear gage *
Dust/waterproof	IP20
Display unit	mm, inch, grad
Resolution	1µm, 0.1µm, 0.01µm
Data output	USB, RS232
Power supply	AC 85~264V, 150mA

- Linear gage:
 - Incremental glass scale sensor, with built-in roller bearing, high precision
 - With lifting lever, for quick measurement
- Display unit:
 - Set zero or output data through foot switch (optional)
 - Measuring direction can be changed
 - The reading can be preset
 - Can make accuracy compensation

* Double channel display is optional

TOOL PRESETTER CODE ISP-TP300

projection screen Ø120mm with scale (protractor with 1° graduation, radius with 0.2, 0.4, 0.8, 1.2, 1.5, 2, 2.5, 3mm)



- Projection screen
- Measure radius, angle, height and squareness
- 99 presetting data can be saved and selected quickly

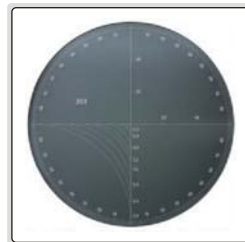

SPECIFICATION

Maximum tool diameter (X axis)	Ø300mm	
Height measuring range (Z axis)	45~450mm	
Accuracy	X axis	±6µm
	Z axis	±13µm
Resolution	0.5µm	
Diameter of projection screen	Ø120mm	
Lens	magnification	20X
	view filed	Ø6mm
Illumination	24V/20W halogen lamp	
Spindle holder	BT50	
Air source pressure	0.6Mpa	
Dimension (L×W×H)	690×620×922mm	
Weight	160kg	

STANDARD DELIVERY

Main unit	1pc
BT50 spindle holder	1pc
Standard rod	1pc
Foot-switch	1pc
Anti-dust cover	1pc



BT50/BT40 converter (optional)



BT50/BT30 converter (optional)



OPTIONAL ACCESSORY

BT50/BT30 converter	ISP-TP300-C1
BT50/BT40 converter	ISP-TP300-C2



CONTOUR MEASURING MACHINE CODE ISQ-PGS200



- Include the software, for contour measurement and data output
- Programmable for automatic cycle measuring, automatically scan contour, mark dimensions, make report, save and print results)
- Operation system: Windows XP, Windows Vista, Windows 7, Windows 8, Windows 8.1
- Output as format pdf, jpg, dxf, etc.

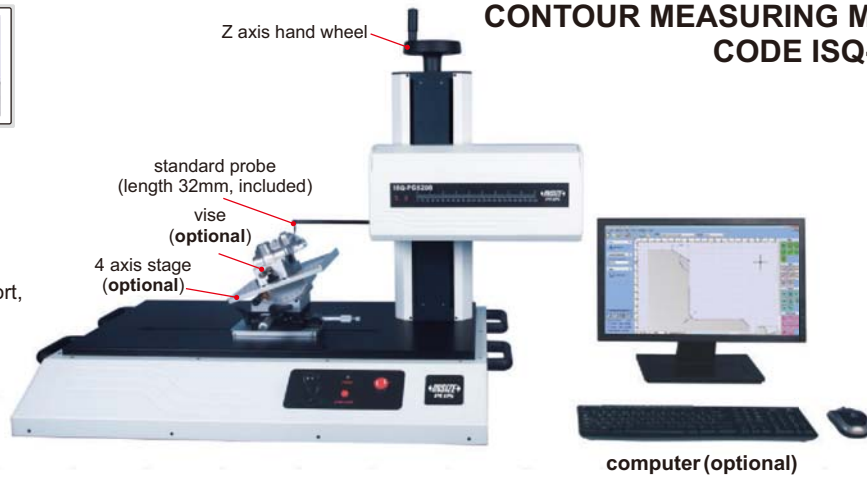

calibration block
(optional)

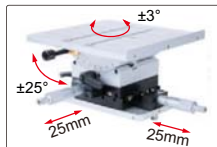

4 axis stage
(optional)

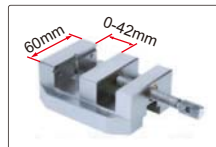

vise
(optional)



standard probe
(length 32mm, included)



software CD
(included)

SPECIFICATION

X axis	Measuring range	200mm
	Resolution	0.5µm
	Accuracy	±(1+L/80)µm, L is the measuring length in mm
Z axis	Measuring range	50mm
	Resolution	0.2µm
	Accuracy	±(1+H/30)µm, H is the measuring height in mm
Traverse speed		0~10mm/s
Measuring speed		0.2mm/s, 0.5mm/s, 1mm/s, 2mm/s
Radius of probe tip		20µm
Measuring unit		mm/inch
Traverse direction		backward
Measuring force		30mN
Traceable angle		75°(upward), 85°(downward)
Travel of Z axis		300mm
Dimension (L×W×H)		1100×570×720mm
Power supply		110~240V/50 ~ 60Hz
Weight		42kg

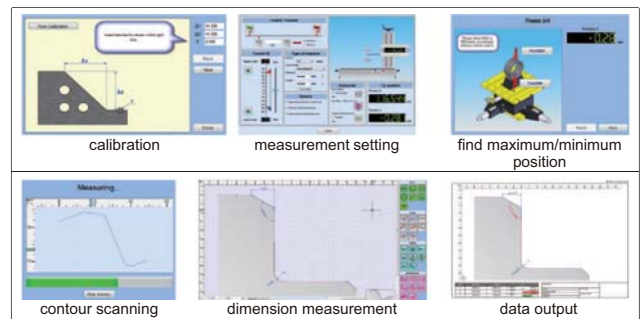

STANDARD DELIVERY

Main unit	1pc
Standard probe (ISQ-PGS-T01)	1pc
Software CD	1pc
USB cable	1pc

OPTIONAL ACCESSORY

Calibration block	ISQ-PGS-CLB
4 axis stage	ISQ-PGS-TABLE
Vise	ISQ-PGS-VISE
Probe	see details

SPECIFICATION OF PROBES

Unit: mm

<p>chisel probes</p> <p>code ISQ-PGS-T01 (L=32mm, included)</p> <p>code ISQ-PGS-T02 (L=22mm, optional)</p> <p>code ISQ-PGS-T03 (L=52mm, optional)</p> <p>code ISQ-PGS-T04 (L=42mm, optional)</p>	<p>Ø1mm ruby ball probe</p> <p>code ISQ-PGS-R01 (optional)</p>	<p>carbide ball probe</p> <p>code ISQ-PGS-C01 (Ø1mm ball, optional)</p> <p>code ISQ-PGS-R02 (Ø2mm ball, optional)</p>	<p>measuring arm and probe for small holes (optional), code ISQ-PGS-SBP</p> <p>measure the contour of holes with diameter > Ø8mm</p>
			<p>transverse measuring arm and probe ISQ-PGS-T01 (optional), code ISQ-PGS-LP</p> <p>measure the contour of holes in radial direction</p>

PROFILE PROJECTORS

Screen diameter: 300mm

X-Y travel: 150x50mm



ISP-Z3015



ISP-A1000E

digital readout of ISP-A1000E

- touch buttons
- USB data output to Excel and CAD
- show diagram directly





software CD (included, only for ISP-A1000E)

OPTIONAL ACCESSORY



lens

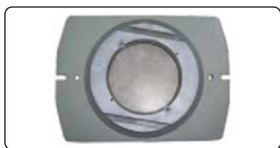

rotary table (glass plate diameter 100mm)

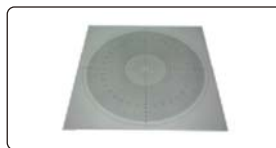

overlay chart (protractor with 1° graduation, radius with 1mm increment)



holder with clamp



swivel center support



V-block with clamp



50mm reading scale (check magnification accuracy)



300mm calibration scale (check magnification accuracy together with 50mm reading scale or calibrate measuring accuracy)

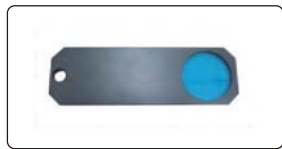

blue filter



demo sample



printer (only for ISP-A1000E)

To be continued

Continued from previous page

SPECIFICATION

Code		ISP-Z3015		ISP-A1000E		
Edge detector		not included		included		
Lens	magnification	10X (included)	20X (optional)	50X (optional)	100X (optional)	
	view field	Ø30mm	Ø15mm	Ø6mm	Ø3mm	
	working distance	77.7mm	44.3mm	38.4mm	25.3mm	
Max. workpiece height		90mm	90mm	90mm	90mm	
Magnification accuracy		±0.08%				
Image		erect image				
Projector screen		diameter: Ø300mm				
		rotation range: 0°~360°, resolution: 1" or 0.01°				
		reference lines: cross-hairs				
Stage	metal stage size	340×152mm				
	glass stage size	196×96mm				
	X-Y stage travel	range: 150×50mm				
		resolution: 0.5µm				
	Z (focus) travel range	accuracy: (4+L/25)µm L is the measuring length in mm				
max. load capacity	90mm					
Illumination		contour illumination: 24V/150W halogen lamp, brightness is adjustable				
		surface illumination: 24V/150W halogen lamp				
Data processing unit	display	X-Y stage travel, screen rotation				
	output	RS232C		RS232C, USB (data output to Excel and CAD)		
	function	measure coordinate of point	measure coordinate of point		measure coordinate of point	
		measure coordinate of line	measure coordinate of line		measure coordinate of line	
measure center coordinate, radius of circle with three points		measure center coordinate, radius of circle with three points		measure center coordinate, radius of circle with three points		
measure distance between two objects		measure distance between two objects		measure distance between two objects		
measure angle with four points or two lines		measure angle with four points or two lines		measure angle with four points or two lines		
set origin of coordinate		set origin of coordinate		set origin of coordinate		
coordinate transform		coordinate transform		coordinate transform		
set midpoint of coordinate		set midpoint of coordinate		choose measurement object automatically according to the selective point and display the result		
advanced function	—		programming for batch measurements			
Power supply		110/220V, 50/60Hz				
Dimension (L×W×H)		550×770×1100mm				
Weight		135kg				

STANDARD DELIVERY

Main unit	1pc
10X lens with half-reflection mirror and oblique illuminator mirror	1pc
Overlay chart clip	4pcs
Foot-switch	1pc
Anti-dust cover	1pc
USB cable and software (only for ISP-A1000E)	1pc

OPTIONAL ACCESSORY

20X lens with half-reflection mirror and oblique illuminator mirror	ISP-Z3015-LENS20X	Swivel center support	ISP-Z3015-SUPPORT
50X lens with half-reflection mirror	ISP-Z3015-LENS50X	V-block with clamp	ISP-Z3015-VBLOCK
100X lens with half-reflection mirror	ISP-Z3015-LENS100X	50mm reading scale	ISP-Z3015-SCALE50
Rotary table	ISP-Z3015-TABLE	300mm calibration scale	ISP-Z3015-RULE
Overlay chart	ISP-Z3015-CHART	Blue filter	ISP-Z3015-FILTER
Holder with clamp	ISP-Z3015-HOLDER	Demo sample	ISP-Z3015-DEMO
		Printer (only for ISP-A1000E)	ISP-A1000-PRINTER

PROFILE PROJECTORS

Screen diameter: 300mm

X-Y travel: 200x100mm



ISP-AZ3020



ISP-A5000E

digital readout of ISP-A5000E

- Adjust the focus by ascending and descending the projector head, the stage doesn't move up and down
- Maximum workpiece weight 50kg

- touch buttons
- USB data output to Excel and CAD
- show diagram directly

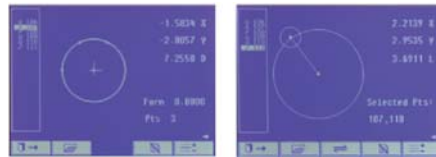

software CD (included, only for ISP-A5000E)

OPTIONAL ACCESSORY



lens

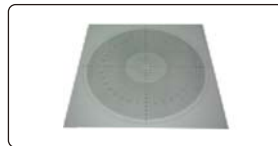

overlay chart (protractor with 1° graduation, radius with 1mm increment)



50mm reading scale (check magnification accuracy)

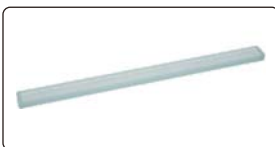

300mm calibration scale (check magnification accuracy together with 50mm reading scale or calibrate measuring accuracy)



demo sample



printer (only for ISP-A5000E)

To be continued

Continued from previous page

SPECIFICATION

Code		ISP-AZ3020	ISP-A5000E		
Edge detector		not included	included		
Lens	magnification	10X (included) 20X (optional)	50X (optional)	100X (optional)	
	view field	Ø30mm Ø15mm	Ø6mm	Ø3mm	
	working distance	77.7mm 44.3mm	38.4mm	25.3mm	
Max. workpiece height		100mm 100mm	100mm	100mm	
Magnification accuracy		±0.08%			
Image		erect image			
Projector screen		diameter: Ø300mm			
		rotation range: 0°~360°, resolution: 1' or 0.01°			
		reference lines: cross-hairs			
Stage	metal stage size	404×228mm			
	glass stage size	260×160mm			
	X-Y stage travel	range: 200×100mm			
		resolution: 0.5µm			
	Z(focus) travel range	accuracy: (3+L/75)µm L is the measuring length in mm			
max. load capacity	100mm				
Illumination		contour illumination: 24V/150W halogen lamp, brightness is adjustable			
		surface illumination: 24V/150W halogen lamp, brightness is adjustable			
Data processing unit	display	X-Y stage travel, screen rotation			
	output	RS232C	RS232C, USB (data output to Excel and CAD)		
	function	measure coordinate of point		measure coordinate of point	
		measure coordinate of line		measure coordinate of line	
measure center coordinate, radius of circle with three points			measure center coordinate, radius of circle with three points		
measure distance between two objects			measure distance between two objects		
measure angle with four points or two lines			measure angle with four points or two lines		
set origin of coordinate			coordinate transform		
coordinate transform			choose measurement object automatically according to the selective point and display the result		
set midpoint of coordinate					
advanced function		—	programming for batch measurements		
Powersupply		110/220V, 50/60Hz			
Dimension (L×W×H)		780×780×1100mm			
Weight		160kg			

STANDARD DELIVERY

Main unit	1pc
10X lens with half-reflection mirror and oblique illuminator mirror	1pc
Overlay chart clip	4pcs
Foot-switch	1pc
Anti-dust cover	1pc
USB cable and software (only for ISP-A5000E)	1pc

OPTIONAL ACCESSORY

20X lens with half-reflection mirror and oblique illuminator mirror	ISP-A5000-LENS20X
50X lens with half-reflection mirror	ISP-A5000-LENS50X
100X lens with half-reflection mirror	ISP-A5000-LENS100X
Overlay chart	ISP-A5000-CHART

50mm reading scale	ISP-A5000-SCALE50
300mm calibration scale	ISP-A5000-RULE
Demo sample	ISP-A5000-DEMO
Printer (only for ISP-A5000E)	ISP-A5000-PRINTER

HORIZONTAL PROFILE PROJECTORS

Screen diameter: 300mm

X-Z travel: 200x100mm



ISP-W3020



ISP-A3000E

digital readout of ISP-A3000E

- touch buttons
- USB data output to Excel and CAD
- show diagram directly







software CD (included, only for ISP-A3000E)

OPTIONAL ACCESSORY

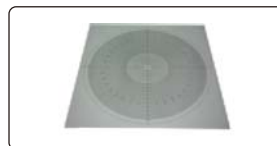

lens



overlay chart (protractor with 1° graduation, radius with 1mm increment)



50mm reading scale (check magnification accuracy)



demo sample



V-block with clamp



rotary table



300mm calibration scale (check magnification accuracy together with 50mm reading scale or calibrate measuring accuracy)



vise



printer (only for ISP-A3000E)

To be continued

Continued from previous page

SPECIFICATION

Code		ISP-W3020	ISP-A3000E	
Edge detector		not included	included	
Lens	magnification	10X (included) 20X (optional)	50X (optional)	100X (optional)
	view field	Ø30mm	Ø15mm	Ø6mm
	working distance	77.7mm	44.3mm	38.4mm
Magnification accuracy		±0.08%		
Projector screen		diameter: Ø300mm		
		rotation range: 0°~360°, resolution: 1' or 0.01°		
		reference lines: cross-hairs		
Stage	metal stage size	400×150mm		
	turning range	±15°		
	X-Z stage travel	range: 200×100mm		
		resolution: 0.5µm		
		accuracy: (4+L/25)µm L is the measuring length in mm		
Y (focus) travel range	75mm			
max. load capacity	50kg			
Illumination		contour illumination: 24V/150W halogen lamp, brightness is adjustable		
		surface illumination: 12V/150W halogen lamp(with 2 fibers), position is adjustable		
Data processing unit	display	X-Z stage travel, screen rotation		
	output	RS232C	RS232C, USB (data output to Excel and CAD)	
	function	measure coordinate of point	measure coordinate of point	
		measure coordinate of line	measure coordinate of line	
measure center coordinate, radius of circle with three points		measure center coordinate, radius of circle with three points		
measure distance between two objects		measure distance between two objects		
measure angle with four points or two lines		measure angle with four points or two lines		
set origin of coordinate		coordinate transform		
coordinate transform		choose measurement object automatically according to the selective point and display the result		
set midpoint of coordinate				
advanced function	—	programming for batch measurements		
Power supply		110/220V, 50/60Hz		
Dimension (L×W×H)		1090×830×1010mm		
Weight		160kg		

STANDARD DELIVERY

Main unit	1pc
10X lens	1pc
Overlay chart clip	4pcs
Foot-switch	1pc
Anti-dust cover	1pc
USB cable and software (only for ISP-A3000E)	1pc

OPTIONAL ACCESSORY

20X lens	ISP-A3000-LENS20X
50X lens	ISP-A3000-LENS50X
100X lens	ISP-A3000-LENS100X
Overlay chart	ISP-A3000-CHART
50mm reading scale	ISP-A3000-SCALE50
300mm calibration scale	ISP-A3000-RULE

Demo sample	ISP-A3000-DEMO
V-block with clamp	ISP-A1000-VBLOCK
Rotary table	ISP-A3000-RTABLE
Vice	ISP-A3000-VISE
Printer (only for ISP-A3000E)	ISP-A3000-PRINTER

HORIZONTAL PROFILE PROJECTORS

Screen diameter: 400mm

X-Z travel: 250x150mm



ISP-W4025



ISP-A7000E

digital readout of ISP-A7000E

- touch buttons
- USB data output to Excel and CAD
- show diagram directly





software CD (included, only for ISP-A7000E)

OPTIONAL ACCESSORY



lens



V-block with clamp



rotary table



demo sample (need rotary table)



vise



printer (only for ISP-A7000E)



300mm calibration scale (check magnification accuracy together with 50mm reading scale or calibrate measuring accuracy)

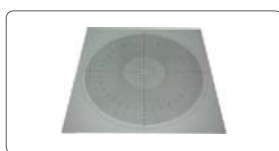

Ø300mm overlay chart (protractor with 1° graduation, radius with 1mm increment)



50mm reading scale (check magnification accuracy)

To be continued

Continued from previous page

SPECIFICATION

Code		ISP-W4025			ISP-A7000E	
Edge detector		not included			included	
Lens	magnification	5X (optional)	10X (standard)	20X (optional)	50X (optional)	100X (optional)
	view field	Ø80mm	Ø40mm	Ø20mm	Ø8mm	Ø4mm
	working distance	93.7mm	103.9mm	95.1mm	65.7mm	35mm
Magnification accuracy		±0.08%				
Image		erect image				
Projector screen		diameter: Ø400mm				
		rotation range: 0°~360°, resolution: 1' or 0.01°				
		reference lines: cross-hairs				
Stage	metal stage size	450×200mm				
	turning range	±15°				
	X-Z stage travel	range: 250×150mm				
		resolution: 0.5µm				
	Y (focus) travel range	accuracy: (4+L/25)µm L is the measuring length in mm				
max. load capacity	100mm					
Illumination		contour illumination: 24V/150W halogen lamp, brightness is adjustable				
		surface illumination: 12V/150W halogen lamp(with 2 fibers), position is adjustable				
Data processing unit	display	X-Z stage travel, screen rotation				
	output	RS232C			RS232C, USB(data output to Excel and CAD)	
	function	measure coordinate of point measure coordinate of line measure center coordinate, radius of circle with three points measure distance between two objects measure angle with four points or two lines set origin of coordinate coordinate transform set midpoint of coordinate 			measure coordinate of point measure coordinate of line measure center coordinate, radius of circle with three points measure distance between two objects measure angle with four points or two lines coordinate transform choose measurement object automatically according to the selective point and display the result 	
Power supply		110/220V, 50/60Hz				
Dimension (L×W×H)		1215×646×1210mm				
Weight		240kg				

STANDARD DELIVERY

Main unit	1pc
10X lens	1pc
Overlay chart clip	4pcs
Foot-switch	1pc
Anti-dust cover	1pc
USB cable and software (only for ISP-A7000E)	1pc

OPTIONAL ACCESSORY

5X lens	ISP-W4025-LENS5X
20X lens	ISP-W4025-LENS20X
50X lens	ISP-W4025-LENS50X
100X lens	ISP-W4025-LENS100X
Ø300mm overlay chart	ISP-A3000-CHART
50mm reading scale	ISP-A3000-SCALE50

300mm calibration scale	ISP-A3000-RULE
Demo sample	ISP-A3000-DEMO
V-block with clamp	ISP-A1000-VBLOCK
Rotary table	ISP-A3000-RTABLE
Vice	ISP-A3000-VISE
Printer (only for ISP-A7000E)	ISP-A3000-PRINTER

VISION MEASURING SYSTEM CODE ISD-A100**

INSPECTION
CERTIFICATE

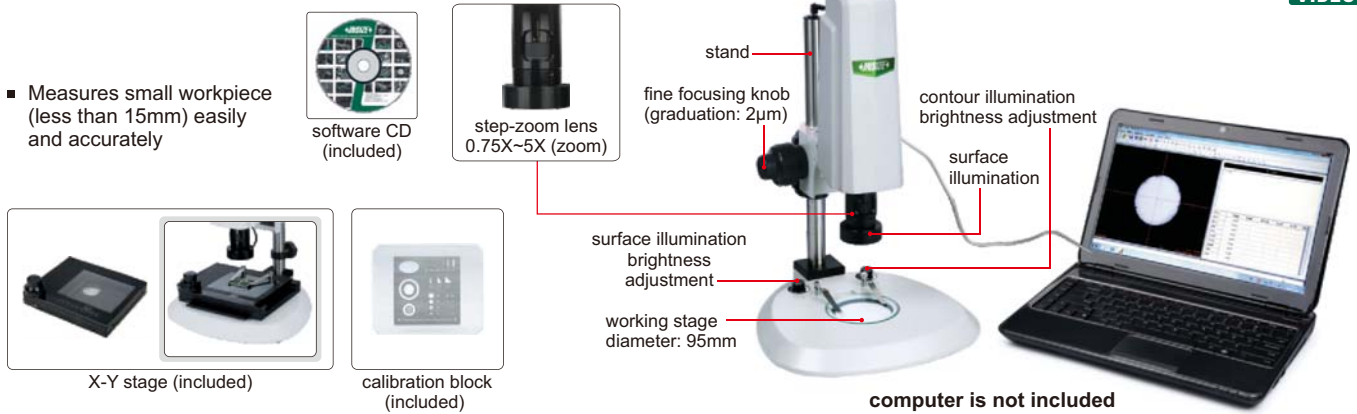

SPECIFICATION

Objective	0.75X~5X (zoom)	
Auxiliary objective	1X (included)	0.5X (included)
Focus distance	82mm	175mm
View field (diagonal length)	1.15mm~7.5mm	2.3mm~15mm
Magnification (19" widescreen display)	44X~280X	22X~140X
Camera	CMOS (color)	
Resolution (pixel)	1280×1024 (1.3M)	
Output	USB2.0	
Accuracy	4µm	
Repeatability	2µm	
Illumination	surface: adjustable ring LED contour: adjustable LED	
Demension (L×W×H)	300×350×450mm	
Weight	2.8kg	

STANDARD DELIVERY

Main unit	1pc
Software disc	1pc
X-Y stage (travel: 74×60mm)	1pc
Calibration block	1pc
0.5X auxiliary objective	1pc
1X auxiliary objective	1pc
Ø95mm glass plate	1pc
Ø95mm white/black plate	1pc
Anti-dust cover	1pc

** Add "-P" on code No. when power supply is 220V, 50/60Hz
Add "-U" on code No. when power supply is 110V, 50/60Hz

SOFTWARE

- Operation system: Windows 7/8/10
- Language: English, Chinese
- Output to CAD, EXCEL and WORD
- Input CAD, to compare with workpieces

- coordinate transform

Focus indicator:

- fast and accurately find the focus distance, eliminate the visual error

Single measuring tools:

- measure coordinate of point
- measure center coordinate, radius, diameter and area of circle
- measure length of line
- measure length and diameter of arc

Combined measuring tools:

- find midpoint of a line
- measure distance between two circles
- find tangent lines between two circles
- measure distance between two points
- find angular bisector between two lines
- find tangent lines between point and circle
- find intersection points between two circles
- measure intersection point between two lines
- find intersection points between circle and line

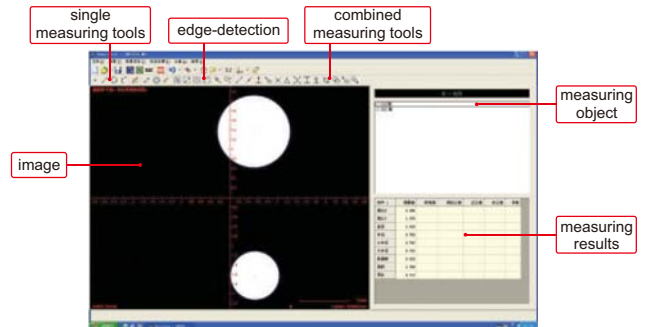

Edge-detection:

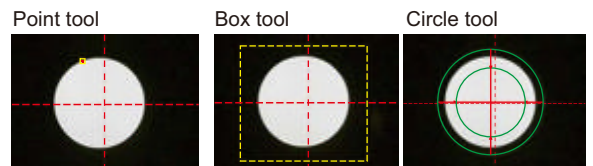

SPECIFICATION

Code	ISD-V150	ISD-V250	ISD-V300
Measuring range (X×Y×Z)	150×100×200mm	250×150×200mm	300×200×200mm
Stage size	354×228mm	450×280mm	500×330mm
Stage glass size	210×160mm	306×196mm	350×250mm
Resolution of X/Y/Z axis	0.5μm		
Accuracy of X/Y axis	≤(2.5+L/100)μm (L is the measuring length in mm)		
Repeatability of X/Y axis	2μm		
Objective	0.7X~4.5X (zoom)		
Working distance	92mm		
Magnification	33X~195X (on 19" monitor)		
Camera	1/3" color CCD, 1.5M pixel		
Illumination	surface and contour with adjustable LED		
Max. height of workpiece	160mm		
Max. weight of workpiece	20kg		
Operation system	Windows 7		
Drive method	manual		
Power supply	110/220V, 50/60Hz		
Dimension (L×W×H)	560×540×850mm	760×600×900mm	760×600×900mm
Weight	100kg	120kg	140kg



VISION MEASURING SYSTEM

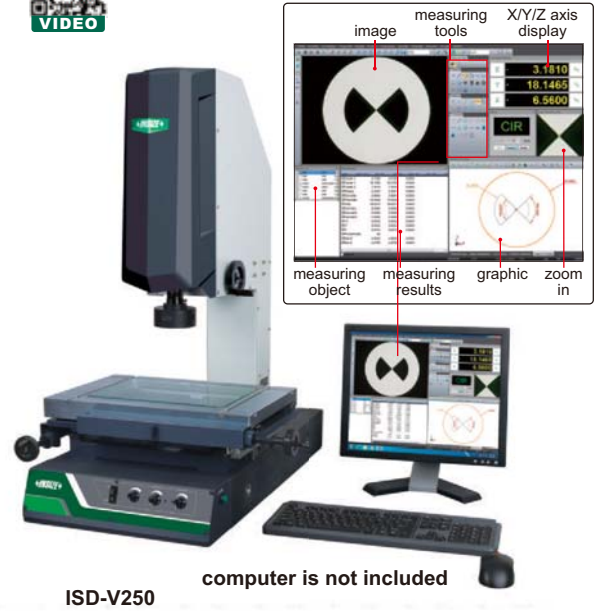

STANDARD DELIVERY

Main unit	1pc
Video card with dongle	1pc
Software disc	1pc
Calibration glass chart	1pc
Laser positioner	1pc
Clay	1pc
Foot switch	1pc
Anti-dust cover	1pc

OPTIONAL ACCESSORY

0.5X auxiliary objective	Code: ISD-V-OB05X Working distance: 175mm Magnification: 16.5~97.5X (on 19" monitor)
2X auxiliary objective	Code: ISD-V-OB2X Working distance: 36mm Magnification: 66~390X (on 19" monitor)
Probe	Code: ISD-V-PROBE Includes Ø2mm and Ø3mm styli, Ø25mm calibration ball
Lens with coaxial light	Code: ISD-V-LENS (must be installed in factory)
Vision measuring system with computer	Code: ISD-V150A, ISD-V250A, ISD-V300A

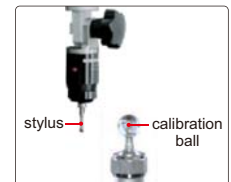

probe (optional), includes Ø2mm and Ø3mm styli, Ø25mm calibration ball, measuring accuracy is 10μm



software CD (included)



lens with coaxial light (optional, must be installed in factory)

SOFTWARE

- Operation system: Windows 7
- Language: English
- Single measuring tools:

measure coordinate of point	measure center coordinate, diameter and area of circle	measure distance between two points	measure length and diameter of arc	measure angle of two lines
measure distance of two elements	measure length, width and diameter of key slot	measure width and diameter of ring	measure length of open curve	measure length and area of close curve
measure focus distance of surface	measure length, width and area of rectangle	measure center coordinate and axis length of ellipse		

■ Combined measuring tools:

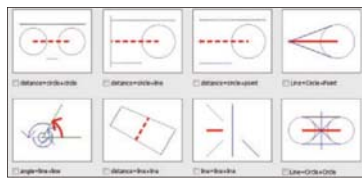

measure distance and angle of two elements

■ Focus indicator:

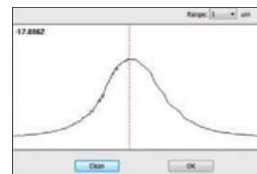

■ Data export to CAD, EXCEL and WORD:

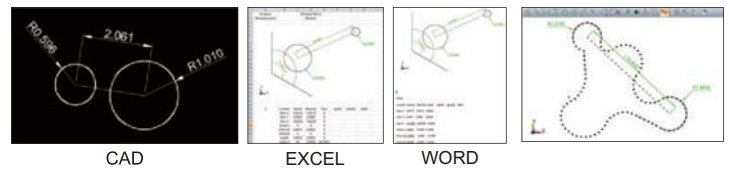

■ Coordinate transfer:

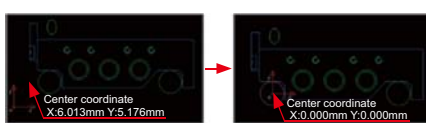

■ Edge-detection:



■ CAD measuring:



Input CAD drawing and set reference, then move the stage to make the target box in the center of crosshair, the software will do automatic measurement

■ Profile detection:



DIGITAL MEASURING MICROSCOPE CODE ISM-DM40

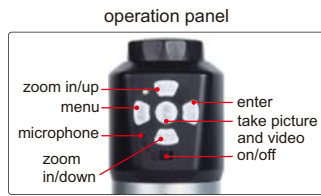

- Connected to TV and computer
- Take pictures and videos, saved to memory card
- Measurement on computer with accuracy $\pm 0.01\text{mm}$
- Large working distance because focus distance of camera is adjustable
- Automatic white balance and exposure, white-black display mode
- Automatic power off



TAKE PICTURES AND VIDEOS

MEASUREMENT (ON COMPUTER)

FOCUS DISTANCE OF CAMERA IS ADJUSTABLE



8G memory card and holder (included)



calibration rule (included, graduation 1mm)



software CD (included)

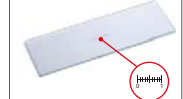

calibration rule (included, graduation 0.1mm)



connected to computer by USB cable, take pictures and videos, make measurement



measuring stage (optional) measure with micrometers by referring to the cross hair on TV screen (X-Y travel: 25×25mm, accuracy: $\pm 2\mu\text{m}$, resolution: 0.001mm)

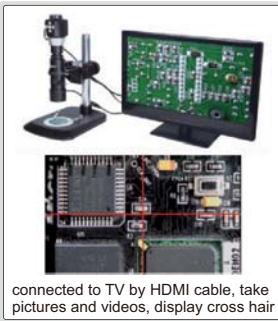

connected to TV by HDMI cable, take pictures and videos, display cross hair

SPECIFICATION

Magnification	15X~205X (on 19" monitor)	
Pixel	3.5M	
Sensor	1/3" CMOS	
Resolution	HDMI output	1920×1080, 1280×720, 640×480
	picture	2304×1536, 2304×1296, 1920×1080, 1280×720, 800×480
	video	1920×1080, 1280×720, 800×480
Output	USB/HDMI	
Power supply	5V (>500mA)	
Dimension (L×W×H)	273×205×310mm	
Weight	3.5kg	

STANDARD DELIVERY

Main unit	1pc
8G memory card and holder	1pc
HDMI cable (for TV)	1pc
USB cable and software (for computer)	1pc
Calibration rule (graduation 0.1mm)	1pc
Calibration rule (graduation 1mm)	1pc

LENS SCALE, MAGNIFICATION AND FOCUS DISTANCE

Lens scale	Magnification (on 19" monitor)	Focus distance (mm)
0.7X	15~40X	24~252
1X	30~50X	27~155
2X	70~80X	81~117
3X	110~120X	94~111
4X	140~160X	101~110
5X	180~205X	103~109

MAGNIFICATION, VIEW FIELD AND FOCUS DISTANCE

Magnification (on 19" monitor)	View filed (mm)	Focus distance
15X	28×16	252mm
30X	13.5×7.5	155mm
50X	8×4.8	124mm
100X	4.2×2.4	110mm
150X	2.7×1.5	108mm
200X	2.1×1.2	105mm

SOFTWARE FOR COMPUTER

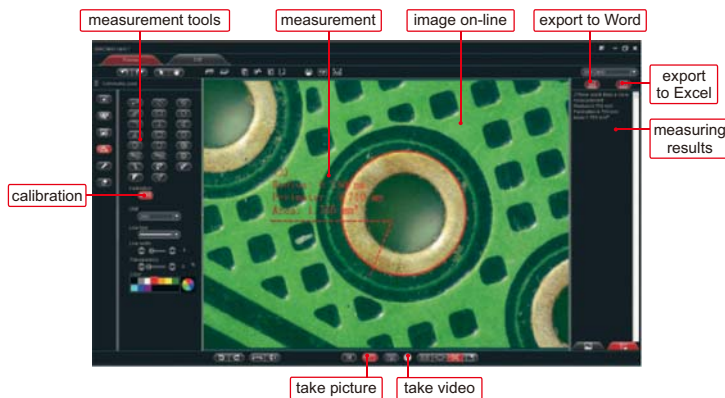

- **Language:** Chinese, English, Japanese, German, French
- **Operation system:** Windows XP/7/8/10
- **Measurement tools:**

- measure length of continuous line
- measure radius, length and angle of arc
- measure angle with three points
- measure distance between two circles
- measure distance between point and line
- measure angle with two lines
- measure radius, girth and area of circle
- measure length of line or distance between two points
- measure distance between two parallel lines
- measure length, width, girth and area of rectangle
- measure center distance between parallel lines
- measure axis lengths, girth and area of ellipse
- measure circumference and area of polygon

Comparison tools:

Create rule, angle or protractor, to compare with workpieces.

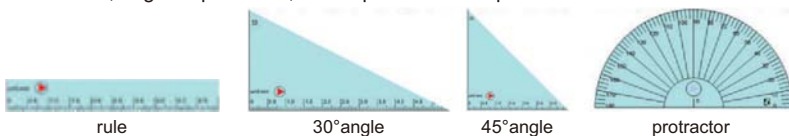

Data export to Word or Excel:

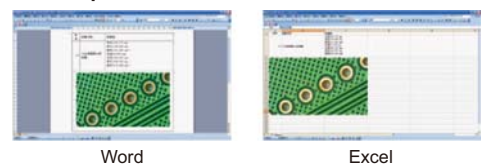

DIGITAL MEASURING MICROSCOPES

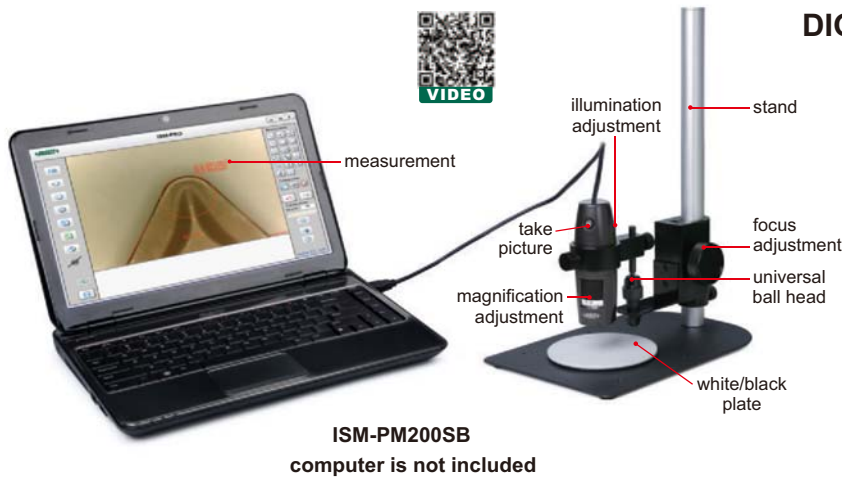

ISM-PM200SB
computer is not included

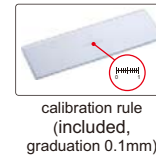
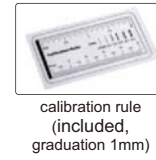

OPTIONAL ACCESSORY

Green filter	ISM-PM-GREEN
Yellow filter	ISM-PM-YELLOW
Blue filter	ISM-PM-BLUE

- Can take pictures and videos
- Supplied with software

SPECIFICATION

Code	ISM-PM200SB	ISM-PM600SB	ISM-PM160LA
Magnification	10X~200X	450X~600X	35X~160X
Type	short focus distance	short focus distance	long focus distance
Focus support	included	not included	not included
Calibration rule	graduation 0.1 and 1mm	graduation 0.1mm	graduation 0.1 and 1mm
Pixel	2M (resolution: 1600×1200)		
Illumination	built-in adjustable LED		
Power supply	USB 2.0 cable (voltage required: 5±0.1V)		

MAGNIFICATION, FOCUS DISTANCE, VIEW FIELD AND ACCURACY

ISM-PM200SB				ISM-PM600SB				ISM-PM160LA			
Magnification	Focus distance	View field (mm)	Accuracy	Magnification	Focus distance	View field (mm)	Accuracy	Magnification	Focus distance	View field (mm)	Accuracy
50X	21mm	8.1×6.4	30µm	450X	1.4mm	0.85×0.67	6µm	50X	62mm	8.1×6.4	30µm
100X	13mm	3.9×3.1	15µm	500X	5.5mm	0.76×0.61	6µm	100X	45mm	3.9×3.1	15µm
150X	16mm	2.6×2.1	10µm	550X	8.6mm	0.69×0.55	5µm	160X	50mm	2.4×1.9	10µm
200X	19mm	1.8×1.5	8µm	600X	11.5mm	0.63×0.51	5µm				

SOFTWARE

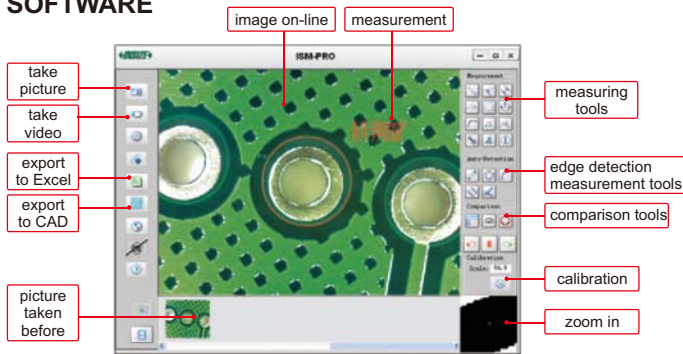

Edge detection measurement tools:

- detect two parallel lines automatically and calculate distance
- detect two lines automatically, and calculate angle
- detect circle automatically, and calculate radius, girth and area
- detect line automatically, and calculate length
- detect arc automatically, and calculate radius, angle and arc length

Data export to CAD or Excel:



- Language:** English, Japanese, Korean, German, Turkey, Portuguese, Chinese

- Operation system:** Windows 7/8/XP/Vista

Measuring tools:

- measure length of line or distance between two points
- measure distance between point and line
- measure area of rectangle
- measure length of continuous line
- measure radius, length and angle of arc
- measure distance between two parallel lines
- measure angle with three points
- measure radius, girth and area of circle
- add number with circle
- add text
- measure distance between two circles

Comparison tools:

- Create line, angle or circle with desired size, to compare with workpieces

- create line
- create angle
- create circle with tolerance



WiFi DIGITAL MEASURING MICROSCOPE CODE ISM-WF200

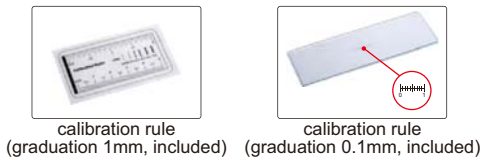

- Maximum working distance is 5m under WiFi mode
- Can be connected to multiple iPads, Android devices or computers at the same time under WiFi mode
- Take pictures and videos
- Supplied with software

SPECIFICATION

Magnification	10X~200X
Pixel	1.3M (resolution: 1280×1024)
Illumination	built-in adjustable LED
Power supply	built-in rechargeable battery

STANDARD DELIVERY

Microscope	1pc
Base support	1pc
Focus support ring for 80X/150X	1pc
Focus support ring for 60X/200X	1pc
Calibration rule (graduation 0.1mm)	1pc
Calibration rule (graduation 1mm)	1pc
USB cable and software	1pc
AC/DC adapter	1pc

OPTIONAL ACCESSORY

Stand	ISM-WSTD
Green filter	ISM-PM-GREEN
Yellow filter	ISM-PM-YELLOW
Blue filter	ISM-PM-BLUE



MAGNIFICATION, FOCUS DISTANCE, VIEW FIELD AND ACCURACY

Magnification	Focus distance	View field	Accuracy
50X	21mm	8.1×6.4mm	30μm
100X	13mm	3.9×3.1mm	15μm
150X	16mm	2.6×2.1mm	10μm
200X	19mm	1.8×1.5mm	8μm

1 Software ISM-PAD (for iPad by WiFi)

Measuring tools:

- measure length of line or distance between two points
- measure angle
- measure radius, girth and area of circle with three points

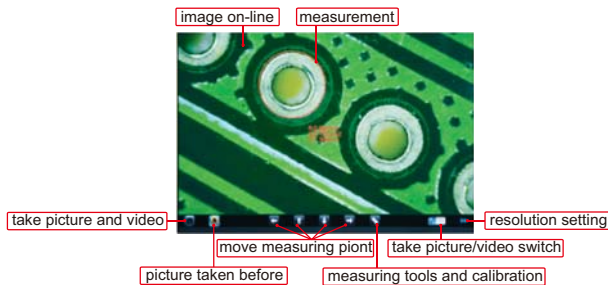

2 Software ISM-APK (for Android devices by WiFi)

Measuring tools:

- measure length of line or distance between two points
- measure angle
- measure radius, girth and area of circle with three points

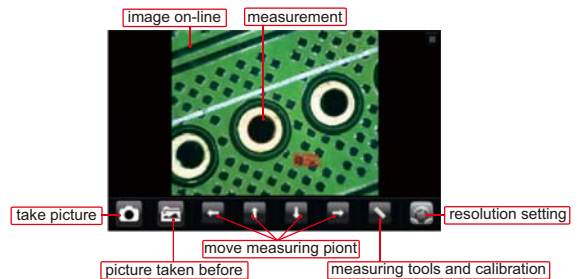

3 Software ISM-WF Partner (for computer by WiFi)

Measuring tools:

- measure length of line or distance between two points
- measure area of polygon
- measure angle with three points
- measure radius, girth and area of circle with center point
- measure length of continuous line
- measure radius, girth and area of circle with three points
- measure angle with two lines
- measure radius, girth and area of circle with two points
- measure distance between point and line
- measure radius, length and angle of arc
- measure area of rectangle

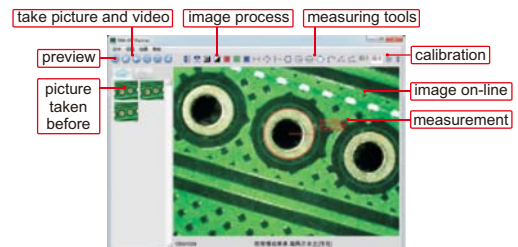

To be continued

Continued from previous page

4 Software ISM-PRO (for computer by USB cable)

Measuring tools:

- measure length of line or distance between two points
- measure length of continuous line
- measure radius, length and angle of arc
- measure distance between two circles
- measure distance between two parallel lines
- measure radius, girth and area of circle
- measure distance between point and line
- measure area of rectangle
- measure angle with three points
- add text
- measure angle with two lines
- add number with circle

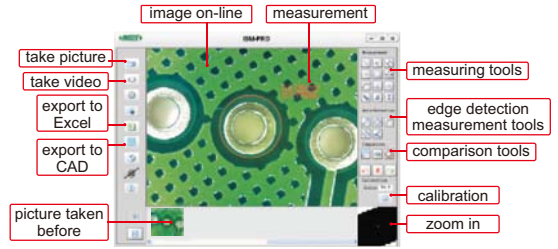

Edge detection measurement tools:

- detect line automatically, and calculate length
- detect circle automatically, and calculate radius, girth and area
- detect two lines automatically, and calculate angle
- detect arc automatically, and calculate radius, angle and arc length
- detect two parallel lines automatically, and calculate distance

Comparison tools:

Create line, angle or circle with desired size, to compare with workpieces

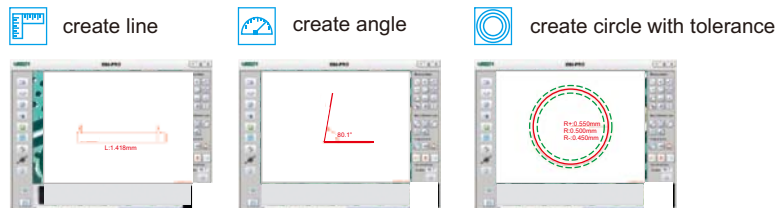

Data export to CAD or Excel:

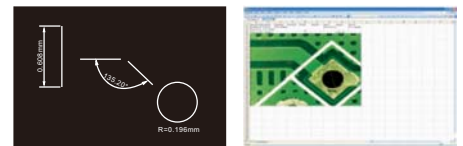

ATTENTION: NOT FOR MEASUREMENT, NOT SUITABLE FOR COMPUTERS



stand (code: ISM-WSTD, optional)



- Connected to TV directly
- For observation, cannot take pictures and videos



ISM-TV200 (with wire)

TV DIGITAL MICROSCOPES



ISM-TV200W (wireless)

SPECIFICATION

Code	ISM-TV200	ISM-TV200W
Type	with wire	wireless (maximum transmission distance 5m)
Magnification	10X-200X (on 17" TV)	
Pixel	0.35M	
Illumination	adjustable brightness LED	
Focus	supplied with focus ring, stand (ISM-WSTD) is optional	
Power supply	DC	built-in rechargeable battery

filter (optional)

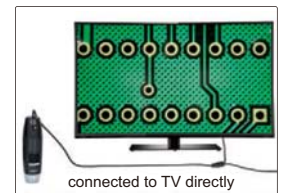

MAGNIFICATION, FOCUS DISTANCE AND VIEW FIELD

ISM-TV200			ISM-TV200W		
Magnification	Focus distance	View field	Magnification	Focus distance	View field
50X	21mm	8.1×6.4mm	60X	19mm	6.9×5.2mm
100X	13mm	3.9×3.1mm	80X	16mm	5.0×3.8mm
150X	16mm	2.6×2.1mm	150X	16mm	2.6×2.1mm
200X	19mm	1.8×1.5mm	200X	19mm	1.8×1.5mm

OPTIONAL ACCESSORY

Green filter	ISM-PM-GREEN
Yellow filter	ISM-PM-YELLOW
Blue filter	ISM-PM-BLUE

DIGITAL ZOOM MICROSCOPE CODE ISM-ZS60

COAXIAL ILLUMINATION

MEASUREMENT (ON COMPUTER)

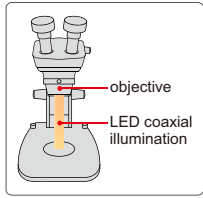

computer is not included

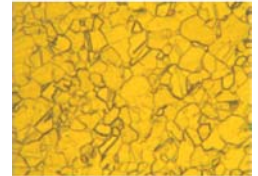
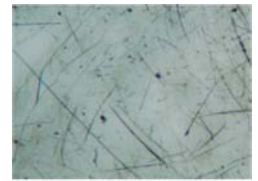

SPECIFICATION

Magnification	38X~230X (on 19" monitor)	
Pixel	5M	
Sensor	1/2.5" CMOS	
Resolution	picture	2592×1944, 1920×1080, 1600×1200, 1280×960, 1280×720, 1024×768, 800×600, 640×480
	video	1920×1080, 1600×1200, 1280×960, 1280×720, 1024×768, 800×600, 640×480
Max. workpiece height	215mm	
Illumination	LED coaxial illumination	
Output	USB	
Power supply	5V, >500mA	
Dimension (L×W×H)	290×260×480mm	
Weight	5.1kg	



calibration rule (included, graduation 1mm)

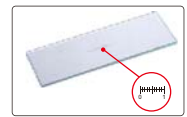

calibration rule (included, graduation 0.1mm)



10X objective (included)



software CD (included)

OBJECTIVE SCALE, MAGNIFICATION, VIEW FIELD AND FOCUS DISTANCE

Objective scale	Magnification (on 19" monitor)	View field	Focus distance
0.8X	38X	7×5mm	130mm
1X	46X	5.5×4.1mm	125mm
2X	92X	2.7×2mm	118mm
3X	144X	1.8×1.3mm	116mm
4X	184X	1.3×1mm	115mm
5X	230X	1.1×0.8mm	114mm

STANDARD DELIVERY

Main unit	1pc
Digital camera	1pc
LED illumination	1pc
10X objective	2pcs
Calibration rule (graduation 0.1mm)	1pc
Calibration rule (graduation 1mm)	1pc
Software CD	1pc
Anti-dust cover	1pc

SOFTWARE FOR COMPUTER

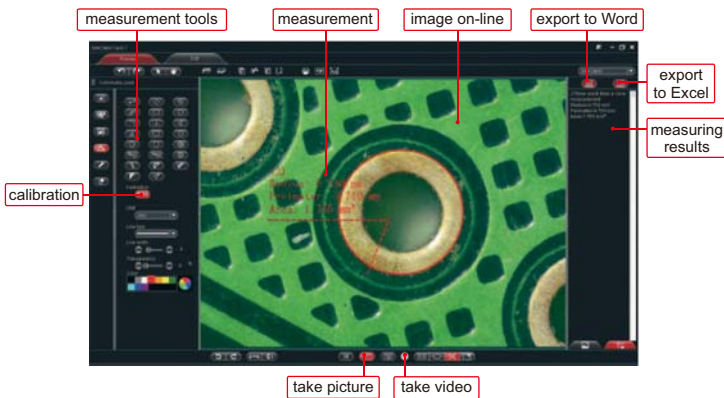

■ **Language:** Chinese, English, Japanese, German, French

■ **Operation system:** Windows XP/7/8/10

■ **Measurement tools:**

- measure length of continuous line
- measure length of line or distance between two points
- measure radius, length and angle of arc
- measure distance between two parallel lines
- measure angle with three points
- measure length, width, girth and area of rectangle
- measure distance between two circles
- measure center distance between parallel lines
- measure distance between point and line
- measure axis lengths, girth and area of ellipse
- measure angle with two lines
- measure circumference and area of polygon
- measure radius, girth and area of circle

■ **Comparison tools:**

Create rule, angle or protractor, to compare with workpieces.

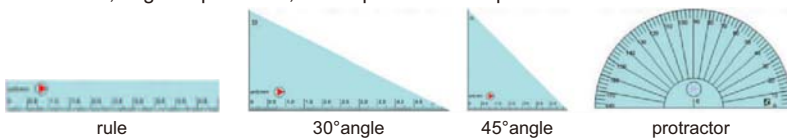

■ **Data export to Word or Excel:**

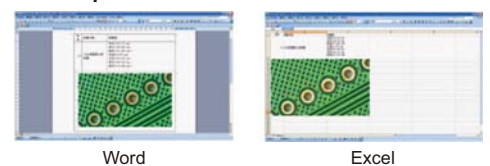



adapter 0.5X
(included)

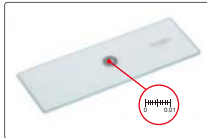

calibration rule
(included, graduation 0.01mm)

- For high magnification observation and metallurgical image analysis
- Infinite optical system, can add optical accessories like polarizer, analyzer, DIC (code ISM-M2000-DIC) into optical path without image quality influence
- Objective can be used in both bright field and dark field
- Kohler illumination system provides uniform illumination field
- Three working modes: 100% eyepiece observation, 100% camera observation, both eyepiece and camera observation (80% illuminance for camera and 20% illuminance for eyepiece)

SPECIFICATION

Eyepiece (wide field)	10X (view field: Ø22mm)				
Objective (plan achromatic)	5X (included)	10X (included)	20X (included)	50X (included)	100X (included)
Numerical aperture	0.12	0.25	0.40	0.75	0.90
Working distance	10mm	10mm	5mm	1.3mm	0.7mm
Stage	double layer, size: 160×140mm, travel: 75×50mm (graduation: 0.1mm)				
Kohler illumination	12V/50W halogen lamp, brightness is adjustable with polarizer and analyzer, built-in green, yellow, blue, gray and frosted glass				
Pupil distance	48~75mm				
Diopter adjustment	±5 diopter (two eyepieces)				
Power supply	110/220V, 50/60Hz				
Dimension (L×W×H)	647×268×376mm				
Weight	12kg				

METALLURGICAL MICROSCOPE CODE ISM-M2000



STANDARD DELIVERY

Main unit	1pc
10X dividing eyepiece (0.1mm/div.)	1pc
Calibration rule (graduation 0.01mm)	1pc
Camera adapter	1pc
Adapter 0.5X	1pc
Anti-dust cover	1pc

OPTIONAL ACCESSORY

15X eyepiece (view field: Ø16mm)	ISM-M2000-15X
20X eyepiece (view field: Ø12mm)	ISM-M2000-20X
DIC	ISM-M2000-DIC
Metallurgical image analysis software and camera	ISM-MAS100

SPECIFICATION

Code	ISM-ZS50	ISM-ZS50T
Optical tube	binocular	trinocular
Eyepiece (wide field)	10X (view field: Ø22mm)	
Objective	0.8X~5X (zoom)	
Zoom ratio	1:6.3	
Pupil distance	55~75mm (adjustable)	
Diopter adjustment	±5 diopter (two eyepieces)	
Working distance of objective	115mm	
Max. workpiece height	215mm	
Illumination	adjustable reflected and transmitted LED light	
Power supply	110/220V, 50/60Hz	
Dimension (L×W×H)	290×260×480mm	
Weight	4.9kg	

ZOOM STEREO MICROSCOPES



ISM-ZS50

STANDARD DELIVERY

Main unit	1pc
WF 10X eyepiece	2pcs
Ø100mm glass plate	1pc
Ø100mm white/black plate	1pc
Anti-dust cover	1pc

OPTIONAL ACCESSORY

Auxiliary objective	0.5X	ISM-ZS50-OB05X
	2X	ISM-ZS50-OB2X
Eyepiece	10X dividing eyepiece (0.1mm/div.)	ISM-ZS50-EPD10X
	WF 15X (view field: Ø16mm)	ISM-ZS50-EP15X
	WF 20X (view field: Ø12mm)	ISM-ZS50-EP20X
Digital camera		ISM-D500

ZOOM STEREO MICROSCOPE CODE ISM-ZS30

SPECIFICATION

Optical tube	binocular
Eyepiece (wide field)	10X (view field: Ø20mm)
Objective	1X~4.5X (zoom)
Zoom ratio	1:4.5
Pupil distance	55~75mm (adjustable)
Diopter adjustment	±5 diopter (two eyepieces)
Working distance of objective	97mm
Max. workpiece height	147mm
Illumination	adjustable reflected and transmitted LED light
Power supply	110/220V, 50/60Hz
Dimension (L×W×H)	260×190×400mm
Weight	4.3kg



STANDARD DELIVERY

Main unit	1pc
WF 10X eyepiece	2pcs
Ø95mm glass plate	1pc
Ø95mm white/black plate	1pc
Anti-dust cover	1pc

OPTIONAL ACCESSORY

Auxiliary objective	0.5X	ISM-ZS30-OB05X
	0.63X	ISM-ZS30-OB06X
	0.75X	ISM-ZS30-OB07X
	2X	ISM-ZS30-OB2X
Eyepiece	10X dividing eyepiece (0.1mm/div.)	ISM-ZS30-EPD10X
	WF15X (view field: Ø16mm)	ISM-ZS50-EP15X
	WF20X (view field: Ø12mm)	ISM-ZS50-EP20X
Digital camera		ISM-D500

HIGH MAGNIFICATION MICROSCOPE CODE ISM-M600**



- For high magnification observation
- Reflected and transmitted illumination can work at the same time
- Objectives 40X, 60X are spring type

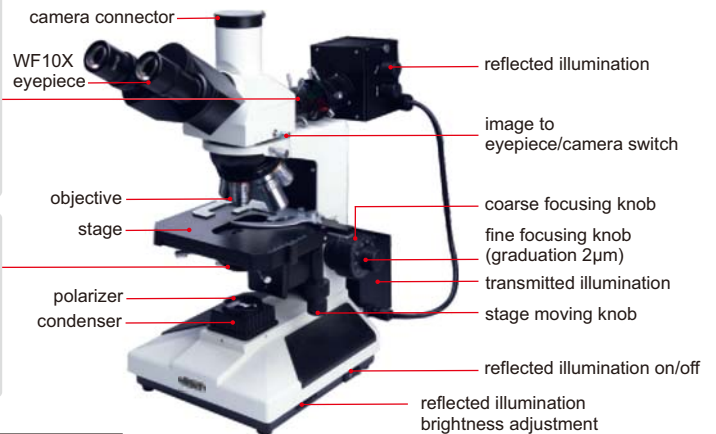
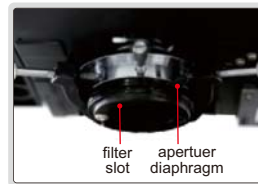
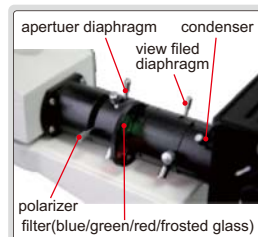

SPECIFICATION

Eyepiece (wide field)	10X (view field: Ø18mm)				
Objective (plan achromatic)	5X	10X	20X	40X	60X
Numerical aperture	0.12	0.25	0.40	0.60	0.75
Working distance	18.4mm	8.8mm	8.6mm	3.7mm	1.34mm
Stage	double layer with sample clamp				
	size: 160×140mm				
	travel: 75×50mm (graduation: 0.1mm)				
Pupil distance	53~75mm				
Diopter adjustment	±5 diopter (one eyepiece)				
Illumination	reflected and transmitted: 6V/20W halogen lamp, brightness is adjustable				
Dimension (L×W×H)	450×300×350mm				
Weight	11kg				

** Add "-P" on code No. when power supply is 220V, 50/60Hz
Add "-U" on code No. when power supply is 110V, 50/60Hz

STANDARD DELIVERY

Main unit	1pc
Anti-dust cover	1pc
Filter (blue/green/frosted glass)	1pc of each

OPTIONAL ACCESSORY

Objective	PL80X	ISM-MTM-OB80X
	PL100X (dry type)	ISM-MTM-OB100X
10X dividing eyepiece (0.1mm/div.)		ISM-MTM-EPD10X
WF16X eyepiece		ISM-MTM-EP16X
WF20X eyepiece		ISM-MTM-EP20X
Camera adapter (1X)		ISM-M600-ADAPTER
Digital camera		ISM-D500

HIGH MAGNIFICATION MICROSCOPE CODE ISM-M1000**

- For high magnification observation
- Kohler illumination system provides uniform illumination field
- Objectives 20X, 40X, 100X are spring type

STANDARD DELIVERY

Main unit	1pc
Oil for 100X objective	1bottle
Anti-dust cover	1pc
Filter (blue/green/yellow)	1pc of each

SPECIFICATION

Eyepiece (wide field)	10X (view field: Ø18mm)			
Objective (plan achromatic)	10X	20X	40X	100X (oil type)
Numerical aperture	0.25	0.40	0.60	1.25
Working distance	8.8mm	8.6mm	3.3mm	0.33mm
Stage	double layer			
	size: 180×150mm			
	travel: 15×15mm			
Pupil distance	53~75mm			
Diopter adjustment	±5 diopter (one eyepiece)			
Illumination	6V/20W halogen lamp			
Power supply	220V, 50/60Hz **			
Dimension (L×W×H)	385×300×440mm			
Weight	11kg			

** Add "-U" on code No. when power supply is 110V, 50/60Hz



OPTIONAL ACCESSORY

Objective	PL50X	ISM-MTM-OB50X
	PL60X	ISM-MTM-OB60X
	PL80X	ISM-MTM-OB80X
	PL100X (dry type)	ISM-MTM-OB100X
10X dividing eyepiece (0.1mm/div.)		ISM-MTM-EPD10X
WF16X eyepiece		ISM-MTM-EP16X
WF20X eyepiece		ISM-MTM-EP20X
Camera adapter (1X)		ISM-M1000-ADAPTER
Digital camera		ISM-D500

DIGITAL CAMERA CODE ISM-D500



- Inserted into eyepiece tube or camera connector of microscopes
- Supplied with software



software CD (included)

application



SPECIFICATION

Sensor	1/2.5" CMOS
Pixel	5M
Resolution	2592×1944 or 1296×972
Frame rate	3fps (2592×1944)
	12fps (1296×972)
Exposure	manual or auto, exposure time is adjustable
SNR	41dB
Power supply	USB
Weight	400g

STANDARD DELIVERY

Main unit	1pc
Adapter 0.45X	1pc
Calibration rule (graduation 0.1mm)	1pc
Connector Ø23.2/Ø30mm	1pc
USB cable	1pc
Software disc	1pc

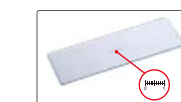

calibration rule (included, graduation 0.1mm)

OPTIONAL ACCESSORY

Connector Ø23.2/Ø30.5mm	ISM-DCA-CON
-------------------------	-------------

SOFTWARE FOR DIGITAL CAMERA (INCLUDED)

Measuring Tools:

- measure distance between two points
- measure rectangle
- measure angle with three points
- calibration
- measure circle

- Can take pictures and videos
- Exposure/gain/gamma/saturation/colour adjustment
- Image process feature: zoom in/out, image flip and so on

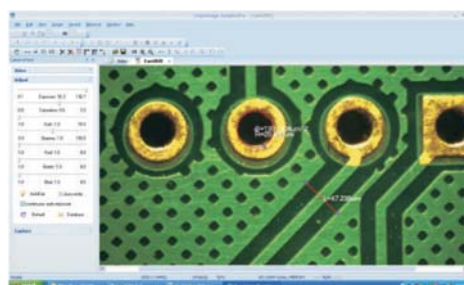

PORTABLE MEASURING MICROSCOPES

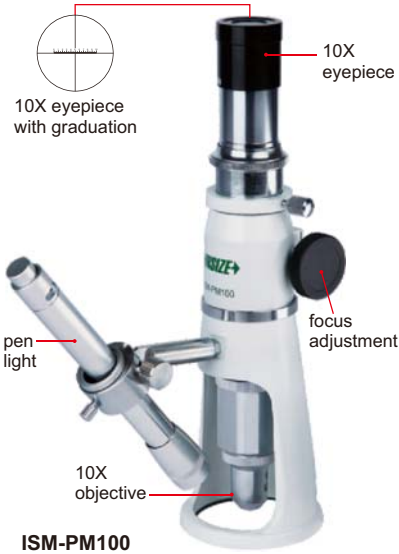

SPECIFICATION

Code	ISM-PM20	ISM-PM40	ISM-PM50	ISM-PM100
Total magnification	20X	40X	50X	100X
Eyepiece	10X with graduation	10X with graduation	10X with graduation	10X with graduation
Objective (achromatic)	2X (numerical aperture: 0.05)	4X (numerical aperture: 0.1)	5X (numerical aperture: 0.12)	10X (numerical aperture: 0.25)
Working distance	17.2mm	18mm	17.6mm	7mm
Graduation	0.05mm	0.025mm	0.02mm	0.01mm
Viewing field	Ø9mm	Ø4.5mm	Ø3.6mm	Ø1.8mm
Focus range	30mm			
Illumination	LED light			
Diameter of base	Ø63mm			
Height	210mm			
Weight	650g			

STANDARD DELIVERY

Main unit	1pc
Pen light	1pc
Battery (AAA)	2pcs

FOLDING MAGNIFIER

- Glass lens

Code	Magnification	Lens diameter (ØD)
7511-8	8X	Ø21mm



7511-8

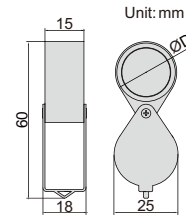

FOLDING MAGNIFIER WITH ILLUMINATION

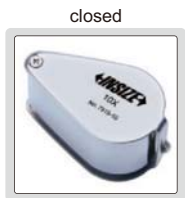

7515-10

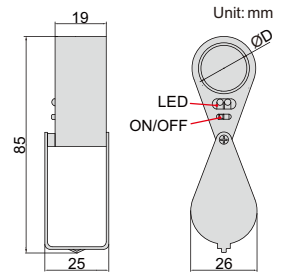

Code	Magnification	Lens diameter (ØD)
7515-10	10X	Ø21mm

- Glass lens
- Powered by 3xLR927 batteries (included)

FOLDING MAGNIFIER WITH ILLUMINATION

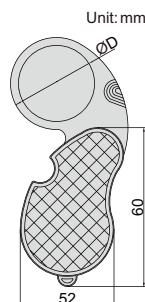
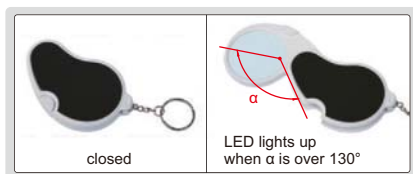

7514-1

- Plastic lens
- Powered by 2xCR1620 batteries (included)
- LED lights up automatically when α is over 130°

Code	Magnification	Lens diameter (ØD)
7514-1	2.5X	Ø45mm



MAGNIFIERS WITH ILLUMINATION

- Glass lens
- Powered by 3xAAA batteries (included)



(mm)

Code	Magnification	Lens diameter (ØD)	L	h
7513-2	2X	Ø75mm	170	90
7513-4	4X	Ø50mm	145	90



7513-2



7513-4

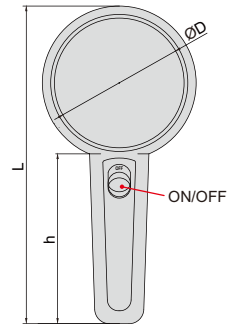

THREE WAYS MAGNIFIER WITH ILLUMINATION

- Plastic lens
- Powered by 2xAAA batteries (included) or power adapter (110~240V, 50~60Hz)

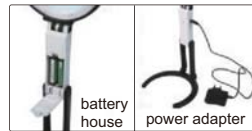

three-way use



Code	Magnification	Lens diameter (ØD)	Lens diameter (Ød)
7512-1	2X/4X	Ø120mm	Ø28mm

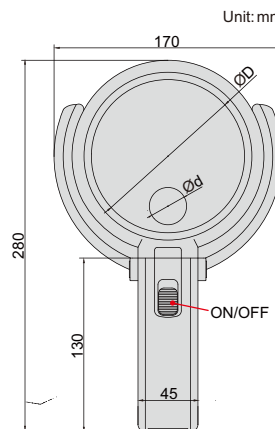

7512-1



MOTORIZED 360° SWIVEL VIDEOSCOPIES

IP65
WATERPROOF

ATTENTION: THE CABLE CAN BE BENT BUT CAN'T BE SET AT A FIXED SHAPE

TUNGSTEN WIRE WEAVED CABLE RESISTANCE TO BREAK AND WEAR



bend in any direction



360° swivel in clockwise and counter-clockwise



bend within ±120°



- Motorized joystick to bend the probe at any direction

SPECIFICATION

Code	ISV-4000D	ISV-4001D	ISV-5000D	ISV-5001D	
Lens	diameter (D)	6mm		4.5mm	
	focus distance (F)	15mm~∞		8~80mm	
	illumination	6pcs LED		6pcs LED	
	pixel	0.41M			
	resolution	720x576			
	dust/waterproof	IP65			
	bend control	motorized joystick			
Cable	length	1.5m	3m	1.5m	
	type	tungsten wire weaved cable			
Main unit	function	take picture, take video			
	file format	picture: JPG, video: AVI			
	image process	brightness, image quality zoom (1X, 2X, 3X)			
	memory	8G SD card			
	output	TV, USB			
power supply	rechargeable battery (for 4 hours working) AC/DC adapter (for continuous working)				
Weight	1kg	1.2kg	0.95kg	1.1kg	



ISV-4000D

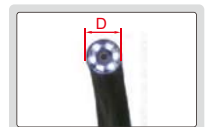

lens with LED adjustable illumination

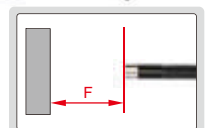

focus distance

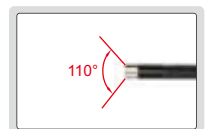

angle of view: 110°

STANDARD DELIVERY

Main unit	1pc
Cable with lens	1pc
8G SD card	1pc
AC/DC adapter	1pc
Video output cable	1pc
USB cable	1pc

ATTENTION: THE CABLE CAN BE BENT BUT CAN'T BE SET AT A FIXED SHAPE

STEEL WIRE WEAVED CABLE RESISTANCE TO BREAK AND WEAR

IP65 WATERPROOF

MANUAL 360° SWIVEL VIDEOSCOPIES

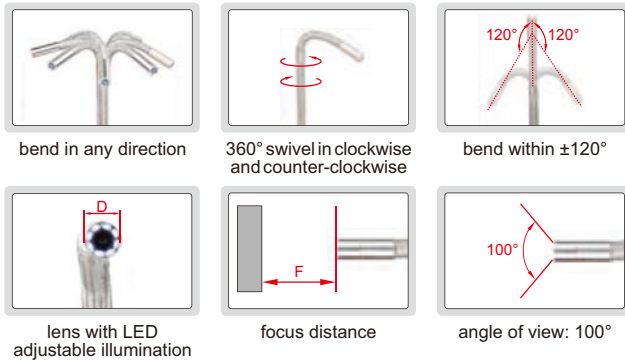

ISV-2000D

SPECIFICATION

Code	ISV-2002D	ISV-2000D	ISV-2001D	ISV-3002D	ISV-3000D	ISV-3001D	
Lens	diameter (D)	6.5mm			4.5mm		
	focus distance (F)	15mm~∞			8~80mm		
	illumination	8pcs LED			6pcs LED		
	pixel	0.3M					
	resolution	640x480					
	dust/waterproof	IP65					
	bend control	manual joystick					
Cable	length	1m	1.5m	3m	1m	1.5m	3m
	type	steel wire weaved cable					
Main unit	function	take picture, take video					
	file format	picture: JPG, video: AVI					
	image process	brightness, image quality zoom (1X, 2X, 3X, 4X, 5X)					
	memory	8G SD card					
	output	TV, USB					
power supply	rechargeable battery (for 2 hours working) AC/DC adapter (for continuous working)						
Weight	600g	650g	800g	550g	600g	700g	

STANDARD DELIVERY

Main unit	1pc
Cable with lens	1pc
8G SD card	1pc
AC/DC adapter	1pc
Video output cable	1pc
USB cable	1pc

OPTIONAL ACCESSORY

Base	ISV-2000D-BASE
------	----------------

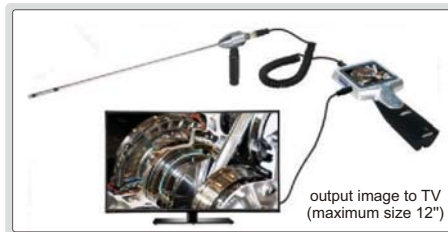

IP57 WATERPROOF

SIDE VIEW VIDEOSCOPE (RIGID) CODE ISV-RV

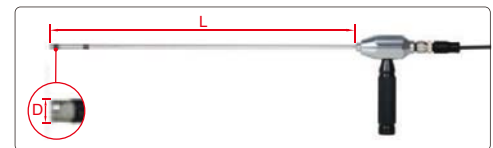
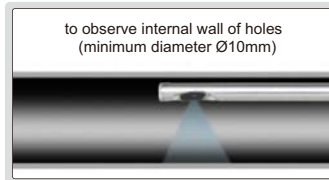
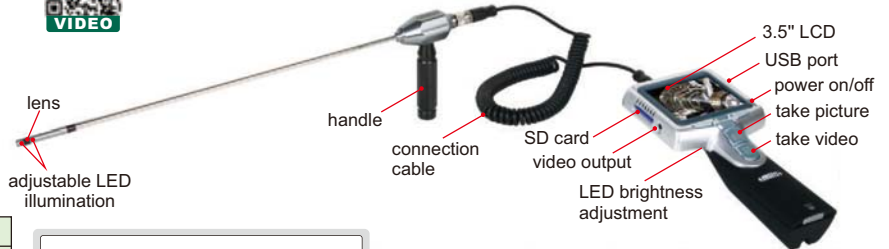

SPECIFICATION

Diameter (D)	5.5mm
Length (L)	350mm
Dust/waterproof probe	IP57
Pixel	0.3M
Resolution	640x480
Frame rate	30fps
Function	take picture, take video
File format	picture: JPG, video: AVI
Memory	2G SD card
Output	TV, USB
Power supply	rechargeable battery (for 3 hours working)
Weight	570g

STANDARD DELIVERY

Main unit	1pc
2G SD card	1pc
AC/DC adapter	1pc
Video output cable	1pc
USB cable	1pc

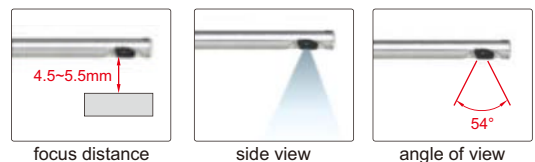

ATTENTION: THE CABLE CAN BE BENT BUT CAN'T BE SET AT A FIXED SHAPE

STEEL WIRE WEAVED CABLE RESISTANCE TO BREAK AND WEAR

OPTIONAL CABLE LENGTH 3M, 5M AND 10M

IP65 WATERPROOF



VIDEOSCOPE CODE ISV-E10

SPECIFICATION

Lens	diameter	5.5mm
	pixel	0.3M
	resolution	640×480
	frame rate	30fps
Cable	length	1m
	type	steel wire weaved cable
Main unit	function	take picture, take video
	file format	picture: JPG, video: AVI
	image process	brightness, contrast, color saturation
	memory	2G SD card
	output	TV, USB
	power supply	rechargeable battery (for 3 hours working)
Weight		450g

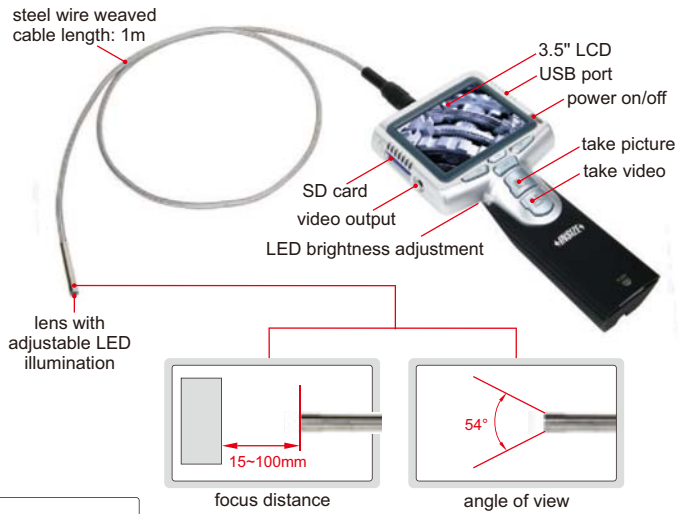

STANDARD DELIVERY

Main unit	1pc
Cable with lens	1pc
2G SD card	1pc
45° mirror	1pc
AC/DC adapter	1pc
Video output cable	1pc
USB cable	1pc
Lens cleaning kit	1pc

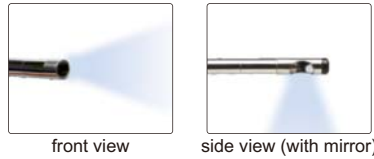

OPTIONAL ACCESSORY

35° mirror	ISV-E55-M35
60° mirror	ISV-E55-M60

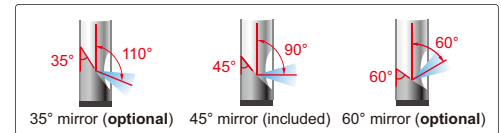

IP57 WATERPROOF

the cable has high illumination and can be set at any shape. it is suitable to observe large internal space like turbocharger.

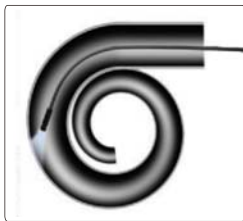

lens with 8pcs LED adjustable illumination

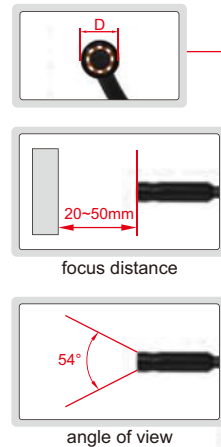

memory cable length: 1m



VIDEOSCOPE CODE ISV-E20

SPECIFICATION

Lens	diameter (D)	12mm
	pixel	0.4M
	resolution	720×682
	frame rate	30fps
Cable	length	1m
	type	memory (can be set at any shape)
Main unit	function	take picture, take video
	file format	picture: JPG, video: AVI
	image process	brightness, contrast, color saturation
	memory	2G SD card
	output	TV, USB
	power supply	rechargeable battery (for 3 hours working)
Weight		600g

STANDARD DELIVERY

Main unit	1pc
Cable with lens	1pc
2G SD card	1pc
AC/DC adapter	1pc
Video output cable	1pc
USB cable	1pc
Lens cleaning kit	1pc

OPTIONAL ACCESSORY

45° mirror	ISV-E20-MIRROR
Hook	ISV-E20-HOOK
Magnet pick up	ISV-E20-MAGNET



magnet pick up (optional)

PIPE VIDEOSCOPE CODE ISV-VP280

ATTENTION: RESISTANCE TO ACID AND ALKALI LIQUID (CONSULT IS NEEDED)

SPECIFICATION

Lens	diameter	28mm
	dust/waterproof	IP68
	pixel	0.3M
	resolution	640×480
Cable	frame	30fps
	length	22m
	dust/waterproof	IP68
Main unit	type	semi-rigid
	function	take picture and video
	file format	picture: JPG, video: ASF
	image process	mirror, rotate, zoom (1.5X, 2X)
	memory	4G SD card
	output	TV, USB
	power supply	4×AA batteries
Weight	5kg	



lens with adjustable LED illumination



IP68
WATERPROOF

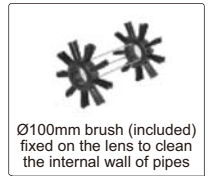

STANDARD DELIVERY

Main unit	1pc
Cable with lens	1pc
Stand	1pc
4G SD card	1pc
Ø100mm brush	1pc
AA battery	4pcs
AAA battery	2pcs
Video output cable	1pc
USB cable	1pc

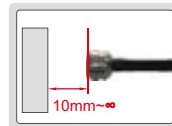

focus distance

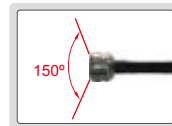

angle of view

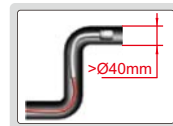

can turn at least two times in the pipe (>Ø40mm)

OPTIONAL ACCESSORY

Ø50mm centering ring	ISV-VP280-R50
Ø150mm brush	ISV-VP280-B150

RIGID BORESCOPIES

IP67
WATERPROOF

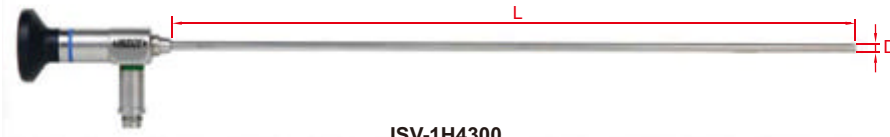

- Focus distance: 2mm, depth of view: 5~100mm
- Dust/waterproof level: IP67
- Can be used in the liquid with temperature -10°C~85°C

ISV-1H4300

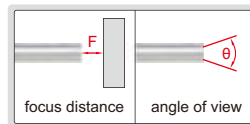

view direction 0°

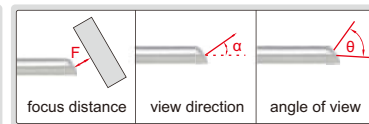

view direction 30° and 70°

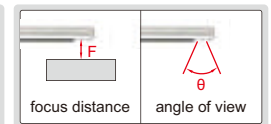

view direction 90°

SPECIFICATION

Code	Length (L)	View direction (α)	Diameter (D)	Angle of view (θ)
ISV-1H4170	174mm	0°	4mm	≥60°
ISV-1H4173	174mm	30°		
ISV-1H4177	174mm	70°		
ISV-1H4179	166mm	90°		
ISV-1H4300	302mm	0°		
ISV-1H4303	302mm	30°		
ISV-1H4307	302mm	70°		
ISV-1H4309	297mm	90°		

Code	Length (L)	View direction (α)	Diameter (D)	Angle of view (θ)
ISV-1H6200	209mm	0°	6mm	≥70°
ISV-1H6203	209mm	30°		
ISV-1H6207	209mm	70°		
ISV-1H6209	166mm	90°		
ISV-1H6320	328mm	0°		
ISV-1H6323	328mm	30°		
ISV-1H6327	328mm	70°		
ISV-1H6329	330mm	90°		

OPTIONAL ACCESSORY

LED light handle	ISV-1HLED
Adjustable LED light source	ISV-1LED1
Camera	ISV-1CAM



LED light handle (optional)



adjustable LED light source (optional)



camera (optional)

- For rigid borescopes (code **ISV-1Hxx**, **ISV-HF4030**, **ISV-HMxx**, **ISV-HPxx**, **ISV-HR6032**)



battery (included)



charger (included)



LED LIGHT HANDLE CODE ISV-1HLED



SPECIFICATION

Power	3W
Battery	3.7V rechargeable battery (for 2 hours working)
Dimension	120×27×27mm
Weight	300g

STANDARD DELIVERY

Main unit	1pc
Battery	1pc
Charger	1pc

- For rigid borescopes (code **ISV-1Hxx**)
- High LED illumination and brightness is adjustable
- For long time work with low noise



ADJUSTABLE LED LIGHT SOURCE CODE ISV-1LED1

SPECIFICATION

Color temperature	5600K
Cooling	fan cooling
Power	AC110~220V, 50/60Hz
Dimension	400×300×112mm
Weight	7kg

STANDARD DELIVERY

Main unit	1pc
1.8m optical fiber cable	1pc

- For rigid borescopes (code **ISV-1Hxx**)
- Connected to computer USB port
- Auto-exposure, auto-gain, auto white balance
- Focus is adjustable



software CD (included)

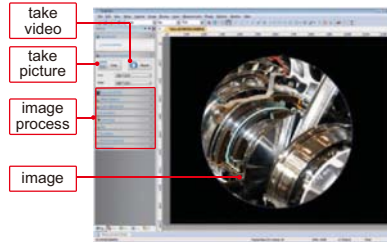

STANDARD DELIVERY

Camera	1pc
Connector	1pc
USB cable and software	1pc

CAMERA CODE ISV-1CAM



SPECIFICATION

Sensor	color CMOS
Pixel	1.3M
Resolution	1280×1024
Frame rate	15~50fps
Software	take picture, take video, zoom in, zoom out, image rotation
Power supply	USB

IP67
WATERPROOF

- Dust/waterproof level: IP67
- Lens can be used in the liquid with temperature -10°C~100°C
- LED light source is needed



camera (optional)



LED light source (optional)



FRONT VIEW BORESCOPE (RIGID) CODE ISV-HF4030



SPECIFICATION

Diameter (D)	4mm
Length (L)	300mm
Depth of view	>15mm
Dust/waterproof lens	IP67
Dimension	410×105×30mm
Weight	220g

STANDARD DELIVERY

Main unit	1pc
Handle	1pc

OPTIONAL ACCESSORY

LED light source	ISV-HL3000
Camera and software	ISV-HCAM

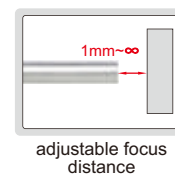

adjustable focus distance

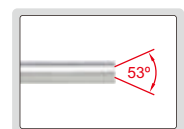

angle of view

BORESCOPIES WITH MIRROR (RIGID)



IP67
WATERPROOF

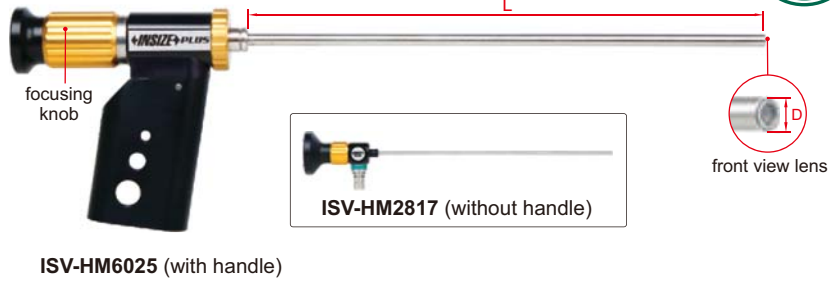
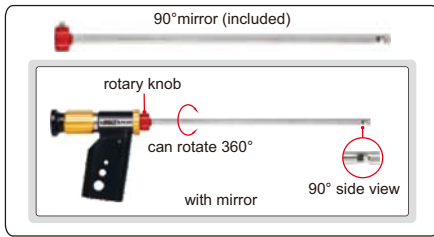

ISV-HM6025 (with handle)

- Front view, side view with mirror
- Dust/waterproof level: IP67
- Lens can be used in the liquid with temperature -10°C~80°C
- LED light source is needed

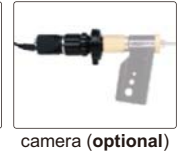
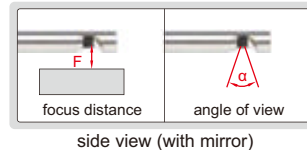
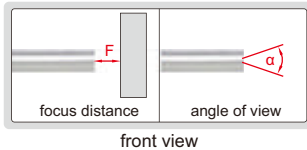

SPECIFICATION

Code	ISV-HM2817	ISV-HM4023	ISV-HM6025	ISV-HM6051
Diameter (D)	2.8mm	4mm	6mm	6mm
Length (L)	175mm	240mm	258mm	490mm
Focus distance (F)	2mm~∞ (adjustable)	6mm~∞ (adjustable)	4mm~∞ (adjustable)	3mm~∞ (adjustable)
Angle of view (α)	22°	22°	34°	48°
Depth of view	>15mm			
Dust/waterproof lens	IP67			
Handle	without	included	included	included
Dimension	235×33×30mm	368×105×30mm	368×105×30mm	610×105×30mm
Weight	55g	250g	260g	300g

STANDARD DELIVERY

Main unit	1pc
Handle (except ISV-HM2817)	1pc
90° mirror	1pc

OPTIONAL ACCESSORY

LED light source	ISV-HL3000
Camera and software	ISV-HCAM

OBLIQUE VIEW BORESCOPES (RIGID)



IP67
WATERPROOF

- Small diameter, used to observe small space
- Dust/waterproof level: IP67
- Lens can be used in the liquid with temperature -10°C~100°C
- Supplied with protection sleeve
- LED light source is needed

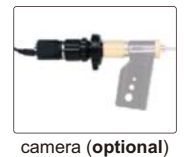
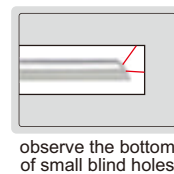
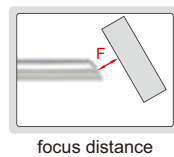
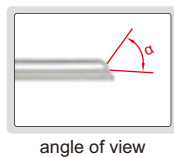
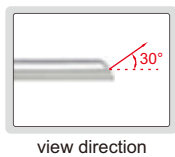
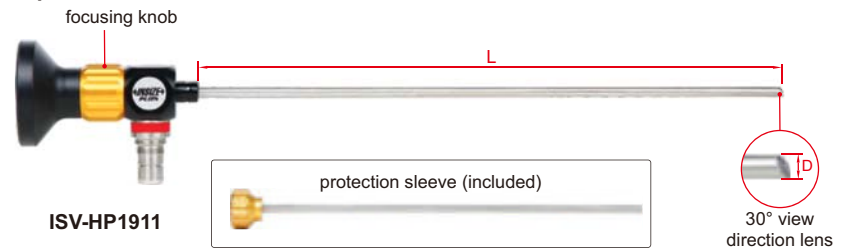

SPECIFICATION

Code	ISV-HP1911	ISV-HP2811	ISV-HP2817
Diameter (D)	1.9mm	2.8mm	2.8mm
Length (L)	110mm	110mm	175mm
Focus distance (F)	0.5mm~∞ (adjustable)	0.5mm~∞ (adjustable)	0.5mm~∞ (adjustable)
View direction	30°		
Angle of view (α)	70°	80°	80°
Depth of view	3~40mm		
Dust/waterproof lens	IP67		
Dimension	162×33×30mm	228×33×30mm	228×33×30mm
Weight	55g	60g	65g

STANDARD DELIVERY

Main unit	1pc
Protection sleeve	1pc

OPTIONAL ACCESSORY

LED light source	ISV-HL3000
Camera and software	ISV-HCAM

IP67
WATERPROOF



VIDEO

- Lens can rotate 350°
- Dust/waterproof level: IP67
- Lens can be used in the liquid with temperature -10°C~100°C
- LED light source is needed



camera (optional)



LED light source (optional)

ROTARY SIDE VIEW BORESCOPE (RIGID) CODE ISV-HR6032

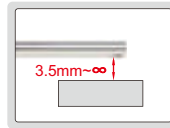
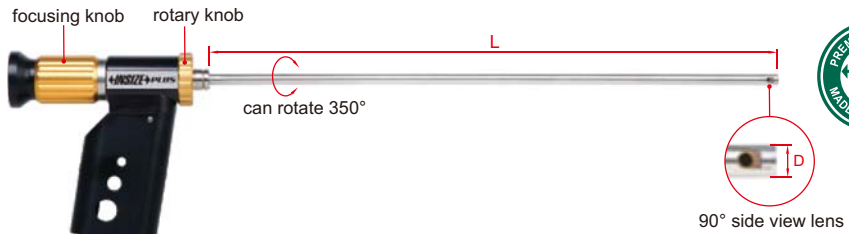

adjustable focus distance

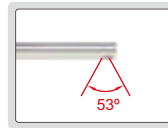

angle of view

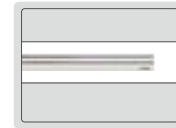

observe internal wall of small holes

SPECIFICATION

Diameter (D)	6mm
Length (L)	320mm
Depth of view	>15mm
Dust/waterproof lens	IP67
Dimension	430x105x30mm
Weight	300g

STANDARD DELIVERY

Main unit	1pc
Handle	1pc

OPTIONAL ACCESSORY

LED light source	ISV-HL3000
Camera and software	ISV-HCAM



- For rigid borescopes (code ISV-HF4030, ISV-HMxx, ISV-HPxx, ISV-HR6032)
- High LED illumination and brightness is adjustable
- For long time work with low noise

SPECIFICATION

Brightness	470lm
Color temperature	5800K
Cooling method	fan cooling
Operating temperature	10~40°C
Working life	30000h
Power supply	12V DC, 5420mA
Dimension	170x196x98mm
Weight	3.8kg

STANDARD DELIVERY

Main unit	1pc
2.3m optical fiber cable	1pc

LED LIGHT SOURCE CODE ISV-HL3000



filter (optional)

OPTIONAL ACCESSORY

Red filter	ISV-HL3000-RED
Green filter	ISV-HL3000-GREEN
Yellow filter	ISV-HL3000-YELLOW
Blue filter	ISV-HL3000-BLUE
3500K color temperature filter	ISV-HL3000-3500K



software CD (included)

SPECIFICATION

Sensor	1/3" color CCD
Pixel	1.3M
Resolution	1280x960
Frame rate	22fps
Focus distance	18~35mm
Software	take picture, take video, zoom in, zoom out, mirror, image rotation
Power supply	USB
Dimension	95x50x50mm
Weight	150g



CAMERA CODE ISV-HCAM

- For rigid borescopes (code ISV-HF4030, ISV-HMxx, ISV-HPxx, ISV-HR6032)
- Connected to computer USB port
- High quality CCD
- Auto-exposure, auto-gain, auto white balance
- Focus is adjustable

STANDARD DELIVERY

Camera	1pc
Connector	1pc
USB cable and software	1pc

SURFACE ROUGHNESS TESTER CODE ISR-S1000B



CAN MEASURE WAVINESS AND CURVED SURFACE WITH RADIUS>5MM

DATA OUTPUT

CUSTOM-MADE PROBES ARE AVAILABLE

THE PROBE CAN BE WITH SKID OR WITHOUT SKID

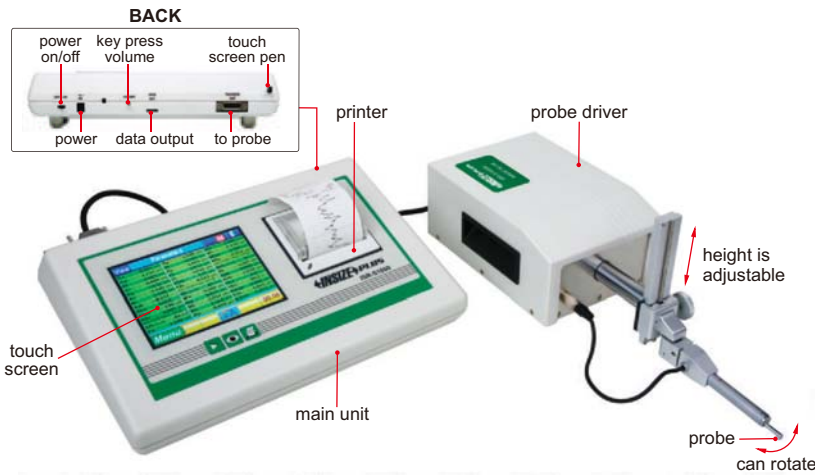

- 48 roughness parameters according to ISO-4287, JIS-B0601, ISO-12085, JIS-B0631
- Automatic probe leveling
- Measuring range up to 1000µm, can measure grit and shot blasting
- Traverse length up to 50mm
- The probe can rotate from -90° to +90°
- Color touch screen, display roughness values, profile and curves
- Can print roughness values, profile and curves
- Memory of maximum 1000 results
- Can set tolerance

measuring software (optional)

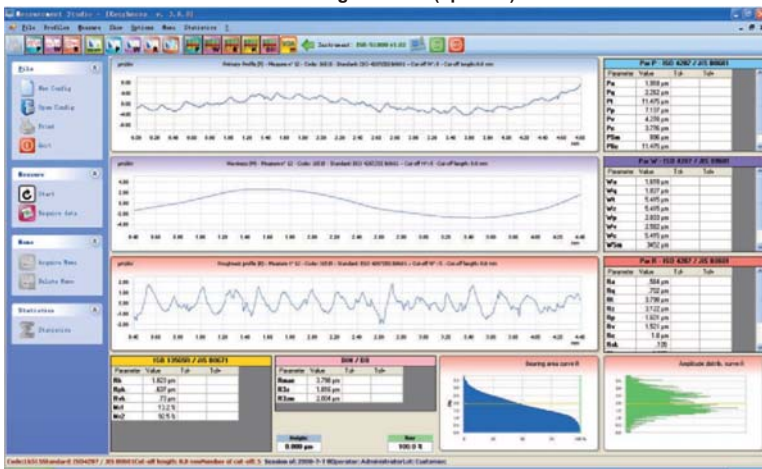

measuring software (optional), can control the roughness tester, display roughness values, profile and curve, data statistics

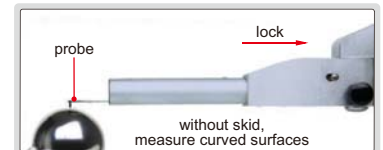
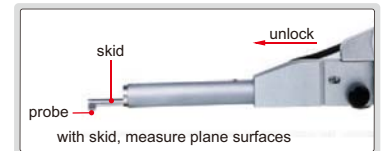

SPECIFICATION

Parameters	Ra, Rq, Rt, Rz, Rp, Rv, Rc, Rsk, Rku, RSm, Rδc, RPa, Rq, Rp, Pt, Pp, Pv, Pc, Psm, Pδc, PPa, Rk, Rpk, Rvk, Mr1, Mr2, Rmax, R3z, R3zm, R, AR, Rx, Aw, Rke, Rpke, Rvke, Mr1e, Mr2e
Range	1000µm
Accuracy	±3%
Resolution (Ra)	0.001µm
Probe	type: inductive stylus radius/angle: 5µm/90° stylus material: diamond
Measuring force	0.75mN
Measuring unit	µm/µin
Cut off	0.08/0.25/0.8/2.5/8mm
Number of cut-offs	1-19 (cut off 0.08/0.25/0.8/2.5mm) 1-5 (cut off 8mm)
Traverse speed	0.5mm/s or 1mm/s
Memory	1000 measurement results
Output	USB
Power	built-in rechargeable battery
Dimension (LxWxH)	320x210x80mm
Weight	2.2kg

ROUGHNESS VALUE, PROFILE AND DATA ANALYSIS

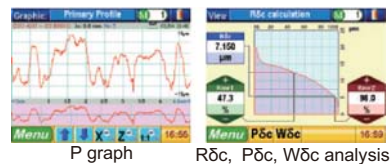
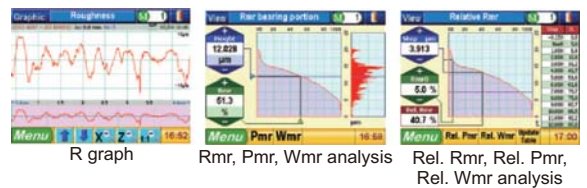
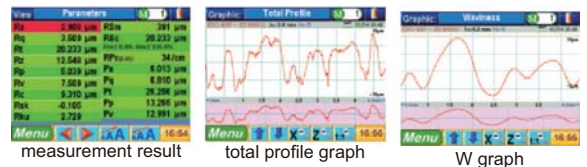

To be continued

Continued from previous page

SURFACE ROUGHNESS TESTER CODE ISR-S1000B

STANDARD DELIVERY

Main unit	1pc
Probe driver	1pc
Standard probe	1pc
Calibration block	1pc
AC/DC adapter	1pc

OPTIONAL ACCESSORY

Probe	see details
USB cable and software	ISR-S-SOFTWARE

SPECIFICATION OF PROBES

Unit: mm

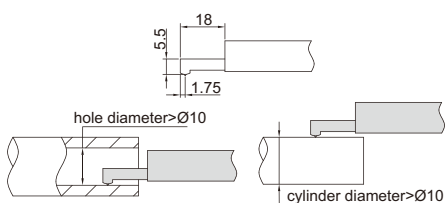
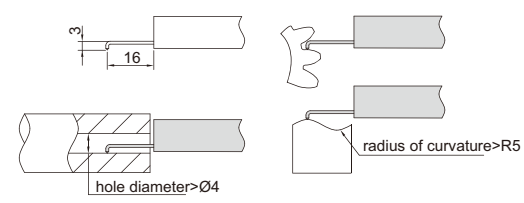
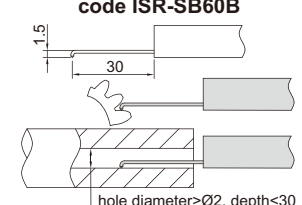
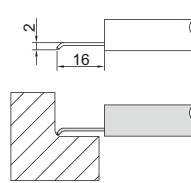
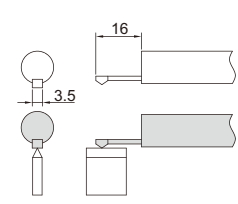
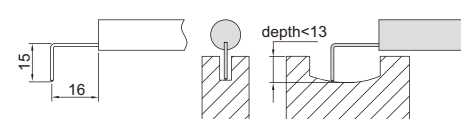
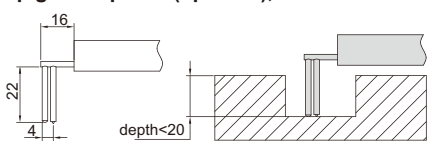
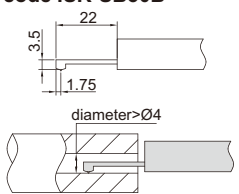
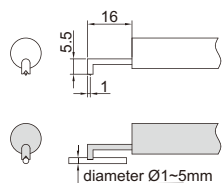
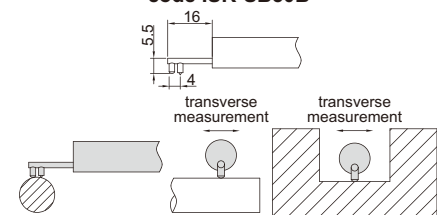
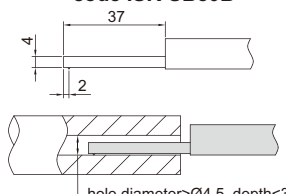
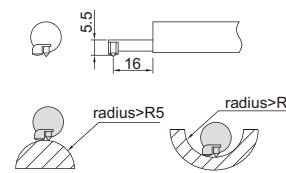
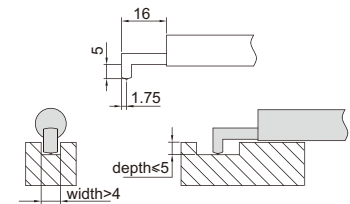
standard probe (included, support is removable), code ISR-SB10B		
 <p style="text-align: center;">with probe support, measure plane surfaces, holes and cylinders with diameter > Ø10mm</p>	 <p style="text-align: center;">without probe support, measure holes with diameter > Ø4mm, can measure curved surfaces, narrow spaces and waviness</p>	
small hole probe (optional), code ISR-SB60B  <p style="text-align: center;">without probe support, measure holes with diameter > Ø2mm and depth < 30mm, can measure curved surfaces, narrow spaces and waviness</p>	internal angle probe (optional), code ISR-SB70B  <p style="text-align: center;">without probe support, measure internal angles, can measure curved surfaces, narrow spaces and waviness</p>	knife edge probe (optional), code ISR-SB130B  <p style="text-align: center;">without probe support, measure knife edges and small rods</p>
deep groove probe (optional), code ISR-SB150B  <p style="text-align: center;">without probe support, measure curved surfaces and grooves with depth < 13mm, can measure curved surfaces, narrow spaces and waviness</p>	deep groove probe (optional), code ISR-SB120B  <p style="text-align: center;">measure grooves with depth < 20mm</p>	
hole probe (optional), code ISR-SB30B  <p style="text-align: center;">measure plane surfaces and holes with diameter > Ø4mm and depth < 20mm</p>	small rod probe (optional), code ISR-SB40B  <p style="text-align: center;">measure small rods with diameter 1~5mm</p>	transverse probe (optional), code ISR-SB50B  <p style="text-align: center;">transverse measurement for plane surfaces, cylinders and grooves</p>
deep hole probe (optional), code ISR-SB80B  <p style="text-align: center;">measure holes with diameter > Ø4.5mm and depth < 35mm</p>	cylinder/hole probe (optional), code ISR-SB110B  <p style="text-align: center;">measure cylinders and holes with radius > R5mm</p>	groove probe (optional), code ISR-SB20B  <p style="text-align: center;">measure plane surfaces and grooves</p>

ROUGHNESS TESTER CODE ISR-S400



software CD
(included)

PROBE CAN
BE CHANGED

DATA
OUTPUT

CUSTOM-MADE
PROBES ARE AVAILABLE



adjustable stand (included)



transverse measurement

- Automatic probe leveling
- Language: English, French, German, Italian, Spanish, Portuguese
- 12 roughness parameters
- Can set tolerance
- Measuring range up to 400µm, can measure grit and shot blasting
- Traverse length up to 16mm
- The probe can be set at 90° or 270°, for transverse measurement
- Memory of maximum 100 results



probe cover (included), can put the small workpieces directly on the probe for measurement

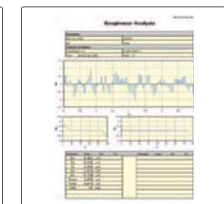

Output software (included), output data and graphic to Excel, make report



measuring software (optional), can control the roughness tester, display roughness values, profile and curve, data statistics



heavy duty test stand (optional)



light duty test stand (optional)

SPECIFICATION

Parameters	Ra, Rq, Rt, Rz, Rc, Rmax, Rsm, Rpc, Rmr, R, AR, Rx	
Range	Ra: 0~100µm, Rt: 0.05~400µm	
Accuracy	±3%	
Resolution (Ra)	0.001µm	
Probe	type	inductive
	stylus radius/angle	5µm/90°
	stylus material	diamond
Measuring force	0.75mN	
Measuring unit	µm/µin	
Cut off	0.25/0.8/2.5mm	
Number of cut-offs	1 to 5	
Traverse speed	1mm/s	
Memory	100 measurement results	
Output	USB	
Power	built-in rechargeable battery	
Dimension (L×W×H)	122×52×68mm	
Weight	650g	

STANDARD DELIVERY

Main unit	1pc
Standard probe	1pc
Calibration block	1pc
Adjustable stand	1pc
AC/DC adapter	1pc
Probe cover	1pc
USB cable and output software	1pc

OPTIONAL ACCESSORY

Extension rod	ISR-S400-ER100
Probe	see details
USB cable and measuring software	ISR-S-SOFTWARE
Heavy duty test stand	ISR-S400-DK
Light duty test stand	ISR-S400-STAND

To be continued

SPECIFICATION OF PROBES

<p>standard probe (included)</p> <p>measure plane surfaces, holes and cylinders with diameter > Ø10mm</p>	<p>small roughness probe (optional) code ISR-S400-SB10R2</p> <p>measure surfaces with small roughness</p>
<p>extension rod (optional) code ISR-S400-ER100</p> <p>for long holes</p>	
<p>groove probe (optional) code ISR-S400-SB20</p> <p>measure plane surfaces and grooves</p>	<p>deep groove probe (optional) code ISR-S400-SB120</p> <p>measure grooves with depth < 20mm</p>
<p>small hole probe (optional) code ISR-S400-SB30</p> <p>measure plane surfaces and holes with diameter > Ø4mm and depth < 20mm</p>	<p>deep hole probe (optional) code ISR-S400-SB80</p> <p>measure holes with diameter > Ø4.5mm and depth < 35mm</p>
<p>small rod probe (optional) code ISR-S400-SB40</p> <p>measure small rods with diameter Ø1-5mm</p>	<p>cylinder/hole probe (optional) code ISR-S400-SB110</p> <p>measure cylinders and holes with radius > R5mm</p>
<p>transverse probe (optional) code ISR-S400-SB50</p> <p>transverse measurement for plane surfaces, cylinders and grooves</p>	<p>internal angle probe (optional) code ISR-S400-SB140</p> <p>measure internal angles</p>

ROUGHNESS TESTER CODE ISR-C100



software CD
(included)



VIDEO

DATA
OUTPUT

- 16 roughness parameters
- With probe position indicator
- Connected with printer via bluetooth
- Can display roughness values, profile and curve
- Memory of maximum 100 results
- Automatic power off

probe cover (included)



can put the small workpieces
directly on the probe for measurement

adjustable stand (included)



Unit: mm

extension rod (optional),
code ISR-C100-ER

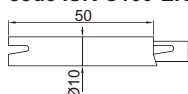

groove probe (optional),
code ISR-C100-130

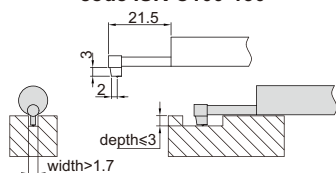

deep groove probe (optional),
code ISR-C100-131

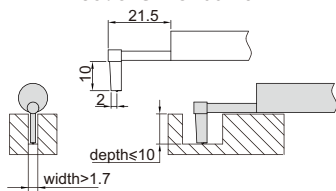

wireless printer (optional)



test stand (optional)



the maximum workpiece
height is 310mm

remote control (included)



Android APP for mobile device (included), the roughness tester can be controlled
by mobile phone or tablet via bluetooth, the maximum working distance is 5m

measuring software for PC (included)

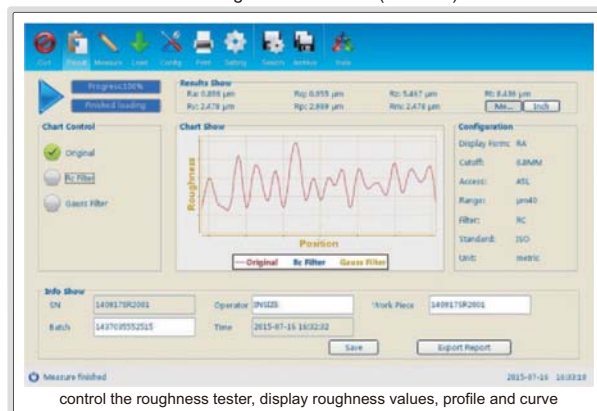

control the roughness tester, display roughness values, profile and curve

SPECIFICATION

Parameters	Ra, Rq, Rz, Rv, Rp, Rm, Rt, RS, Rsm, R3z, R3y, Rz (JIS), Rku, Rsk, Rmax, Rpc	
Range	160µm	
Accuracy	±10%	
Resolution (Ra)	0.001µm	
Probe	type	inductive
	stylus radius/angle	5µm/90°
	stylus material	diamond
	Measuring force	4mN
Measuring unit	µm/µin	
Cut off	0.25/0.8/2.5mm	
Number of cut-offs	1 to 5	
Traverse speed	0.5mm/s, 1mm/s	
Memory	100 measurement results	
Output	USB and bluetooth	
Power	built-in rechargeable battery	
Dimension (L×W×H)	140×52×48mm	
Weight	440g	

STANDARD DELIVERY

Main unit	1pc
Standard probe	1pc
Calibration block and support	1pc of each
Adjustable stand	1pc
Probe cover	1pc
USB cable and software for PC	1pc
Android APP for mobile device	1pc
AC/DC adapter	1pc

OPTIONAL ACCESSORY

Extension rod	ISR-C100-ER
Groove probe	ISR-C100-130
Deep groove probe	ISR-C100-131
Test stand	ISR-C100-STAND
Wireless printer	ISR-C100-PRINTER

screen display

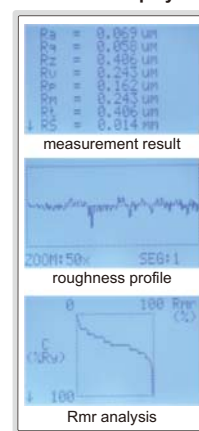

ROUGHNESS TESTER CODE ISR-C002

DATA
OUTPUT



VIDEO



software CD
(included)

probe cover (included)



put the small workpieces directly
under the probe for measurement

adjustable stand (included)



Unit: mm

extension rod (optional),
code ISR-C002-ER

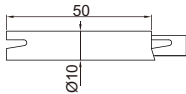

small hole probe (optional),
code ISR-C002-SBP

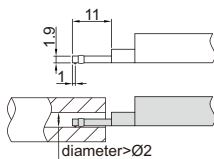

deep groove probe (optional),
code ISR-C002-DGP

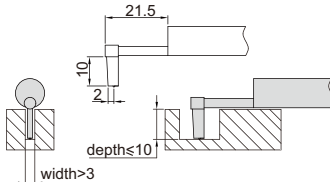

wireless printer (optional)



test stand (optional)



the maximum workpiece
height is 310mm

- 21 roughness parameters
- Connected with printer via bluetooth
- Display roughness values, profile and curve
- Memory of maximum 100 results
- Automatic power off

measuring software for PC (included)

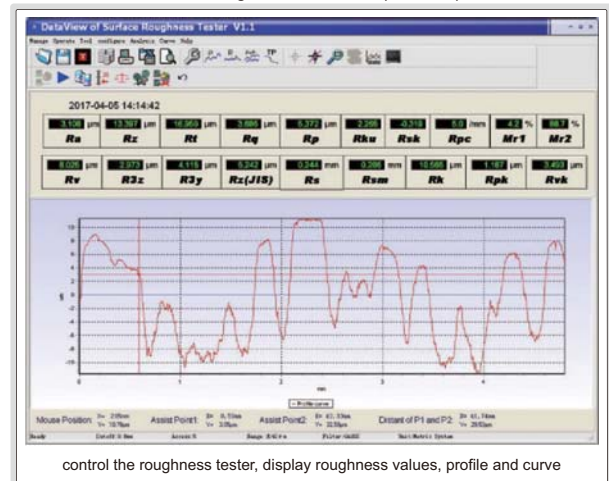

control the roughness tester, display roughness values, profile and curve

screen display

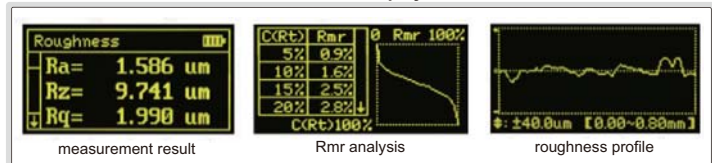

SPECIFICATION

Parameters	Ra, Rz, Rq, Rv, Rp, RS, R3z, R3y, Rt, Rz (JIS), Rk, Rku, Rsm, Rpc, Rpk, Rvk, Rsk, Mr1, Mr2, Ry (JIS), Rmax	
Range	160μm	
Accuracy	±10%	
Resolution (Ra)	0.001μm	
Probe	type	inductive
	stylus radius/angle	5μm/90°
	stylus material	diamond
Measuring force	4mN	
Measuring unit	μm/μin	
Cut off	0.25/0.8/2.5mm	
Number of cut-offs	1 to 5	
Traverse speed	0.5mm/s, 1mm/s	
Memory	100 measurement results	
Output	USB and bluetooth	
Power	built-in rechargeable battery	
Dimension (L×W×H)	141×55×40mm	
Weight	400g	

STANDARD DELIVERY

Main unit	1pc
Standard probe	1pc
Calibration block and support	1pc of each
Adjustable stand	1pc
Probe cover	1pc
USB cable and software for PC	1pc
AC/DC adapter	1pc

OPTIONAL ACCESSORY

Extension rod	ISR-C002-ER
Deep groove probe	ISR-C002-DGP
Small hole probe	ISR-C002-SBP
Test stand	ISR-C002-STAND
Wireless printer	ISR-C002-PRINTER

ROUGHNESS TESTER CODE ISR-C003

- Unit: μm , μin
- Automatic power off

SPECIFICATION

Parameters		Ra, Rz, Rq, Rt
Range		Ra, Rq: 0.05 ~ 15 μm Rz, Rt: 0.1 ~ 50 μm
Accuracy		$\pm 10\%$
Resolution (Ra)		0.01 μm
Probe	type	piezoelectric
	stylus radius/angle	10 $\mu\text{m}/90^\circ$
	stylus material	diamond
Measuring force		5mN
Measuring unit		$\mu\text{m}/\mu\text{in}$
Cut off		0.25/0.8/2.5mm
Evaluation length		1.25mm for cut off 0.25mm 4mm for cut off 0.8mm 5mm for cut off 2.5mm
Traverse speed		0.75mm/s
Power		built-in rechargeable battery
Dimension (L×W×H)		106×70×24mm
Weight		200g



VIDEO



calibration block and support (included)

STANDARD DELIVERY

Main unit	1pc
Calibration block and support	1pc of each
AC/DC adapter	1pc

SURFACE ROUGHNESS SPECIMENS



- For checking, identifying and specifying the roughness by symbol
- Rust-proof, made of pure Nickel



ISR-CS315

Code	Machining method	Roughness (Ra)	Roughness (Rz)	Quantity
ISR-CS315	Surface grinding	0.025, 0.05, 0.1, 0.2, 0.4, 0.8, 1.6, 3.2 μm	0.29, 0.55, 0.91, 1.74, 2.6, 4.65, 7.87, 15.6 μm	8pcs
ISR-CS316	Cylindrical grinding	0.025, 0.05, 0.1, 0.2, 0.4, 0.8, 1.6, 3.2 μm	0.3, 0.53, 0.88, 1.56, 2.64, 4.4, 7.71, 15.3 μm	8pcs
ISR-CS317	Flat lapping	Criss-cross	0.025, 0.05, 0.1, 0.2 μm	0.4, 0.6, 0.74, 1.26 μm
		Parallel	0.025, 0.05, 0.1, 0.2 μm	0.34, 0.56, 1.12, 1.5 μm
ISR-CS318	Cylindrical lapping	0.025, 0.05, 0.1, 0.2 μm	0.46, 0.54, 0.63, 1.23 μm	4pcs
	Superfinishing	0.025, 0.05, 0.1, 0.2 μm	0.36, 0.7, 1, 1.4 μm	4pcs
ISR-CS319	Face turning	0.4, 0.8, 1.6, 3.2, 6.3, 12.5, 25, 50 μm	1.92, 3.2, 6.15, 12.5, 23.7, 48.7, 102, 185 μm	8pcs
ISR-CS320	Cylindrical turning	0.4, 0.8, 1.6, 3.2, 6.3, 12.5, 25, 50 μm	1.7, 3.2, 6.1, 12.2, 23.7, 47.5, 95, 190 μm	8pcs
ISR-CS321	End milling	0.4, 0.8, 1.6, 3.2, 6.3, 12.5, 25, 50 μm	1.92, 3.82, 6.45, 12.2, 25.2, 49.8, 92.6, 191 μm	8pcs
ISR-CS322	Reaming	0.4, 0.8, 1.6, 3.2 μm	1.7, 3.2, 6.4, 12.8 μm	4pcs
	Drilling	1.6, 3.2, 6.3, 12.5 μm	7.5, 15.5, 31, 60 μm	4pcs
ISR-CS323	Horizontal milling	0.4, 0.8, 1.6, 3.2, 6.3, 12.5, 25, 50 μm	1.8, 3.68, 6.63, 12.8, 25.6, 53, 97.5, 197 μm	8pcs
ISR-CS325	Shaping (planing)	0.8, 1.6, 3.2, 6.3, 12.5, 25, 50, 100 μm	3.84, 6.7, 12.2, 25.2, 48.7, 99.9, 190, 361 μm	8pcs
ISR-CS326	Linishing (belt sanding)	0.1, 0.2, 0.4, 0.8, 1.6, 3.2 μm	0.9, 1.55, 3.37, 7.42, 18.5, 31 μm	6pcs
ISR-CS328	Vertical grinding	0.2, 0.4, 0.8, 1.6, 3.2, 6.3 μm	1.1, 3.5, 6.15, 8.78, 22.19, 40.8 μm	6pcs
ISR-CS329	Grit blasting	3.2, 10.5, 18, 25 μm	19.2, 63, 108, 150 μm	4pcs
	Shot blasting	3.2, 8, 13, 18 μm	19.2, 48, 78, 108 μm	4pcs
ISR-CS331	Spark erosion (EDM)	0.4, 0.8, 1.6, 3.2, 6.3, 12.5, 25, 50 μm	2.5, 4.5, 7.2, 14.2, 24.7, 51.2, 105, 196 μm	8pcs
ISR-CS333	Hand filing	0.4, 0.8, 1.6, 3.2, 6.3 μm	3, 5.6, 12.4, 22.5, 61 μm	5pcs
ISR-CS334	Castings	0.8, 1.6, 3.2, 6.3, 12.5, 25, 50 μm	3.2, 8, 16, 32, 56, 112, 225 μm	7pcs
ISR-CS335	Honing	0.05, 0.1, 0.2, 0.4, 0.8, 1.6 μm	0.31, 0.56, 1, 2, 4, 2, 9 μm	6pcs
ISR-CS336	Polishing	0.0125, 0.025, 0.05, 0.1, 0.2 μm	0.29, 0.35, 0.67, 0.72, 1.52 μm	5pcs

ATTENTION: PLEASE APPLY ANTI-RUST OIL AFTER USE

SURFACE ROUGHNESS SPECIMEN SET CODE ISR-CS2



Machining method	Roughness (Ra)	Roughness (Rz)	Quantity
Horizontal milling	0.4, 0.8, 1.6, 3.2, 6.3, 12.5µm 16, 32, 63, 125, 250, 500µm	1.6, 3.2, 6.3, 12.5, 25, 50µm	6pcs
Vertical milling	0.4, 0.8, 1.6, 3.2, 6.3, 12.5µm 16, 32, 63, 125, 250, 500µm	1.6, 3.2, 6.3, 12.5, 25, 50µm	6pcs
Turning	0.4, 0.8, 1.6, 3.2, 6.3, 12.5µm 16, 32, 63, 125, 250, 500µm	1.6, 3.2, 6.3, 12.5, 25, 50µm	6pcs
Plain grinding	0.05, 0.1, 0.2, 0.4, 0.8, 1.6µm 2, 4, 8, 16, 32, 63µm	0.2, 0.4, 0.8, 1.6, 3.2, 6.3µm	6pcs
Flat lapping	0.05, 0.1µm 2, 4µm	0.2, 0.4µm	2pcs
External grinding	0.2, 0.4, 0.8, 1.6µm 8, 16, 32, 63µm	0.8, 1.6, 3.2, 6.3µm	4pcs

- For checking, identifying and specifying the roughness by symbol
- Made of carbon steel

SURFACE ROUGHNESS SPECIMEN SET CODE ISR-CS130

- For checking, identifying and specifying the roughness by symbol
- Rust-proof, made of pure Nickel



Machining method	Roughness (Ra)	Roughness (Rz)	Quantity
Flat lapping	0.05, 0.1, 0.2µm 2, 4, 8µm	0.55, 1, 1.6µm	3pcs
Reaming	0.4, 0.8, 1.6µm 16, 32, 63µm	3, 6, 10µm	3pcs
Plain grinding	0.05, 0.1, 0.2, 0.4, 0.8, 1.6µm 2, 4, 8, 16, 32, 63µm	0.55, 1, 1.6, 3, 6, 10µm	6pcs
Horizontal milling	0.4, 0.8, 1.6, 3.2, 6.3, 12.5µm 16, 32, 63, 125, 250, 500µm	2.5, 4, 8, 16, 32, 50µm	6pcs
Vertical milling	0.4, 0.8, 1.6, 3.2, 6.3, 12.5µm 16, 32, 63, 125, 250, 500µm	2.5, 4, 8, 16, 32, 50µm	6pcs
Turning	0.4, 0.8, 1.6, 3.2, 6.3, 12.5µm 16, 32, 63, 125, 250, 500µm	2.5, 4, 8, 16, 32, 50µm	6pcs

SURFACE ROUGHNESS REFERENCE SPECIMENS

MEASURING ACCURACY CAN BE IMPROVED, IF THE CALIBRATION IS MADE ON A REFERENCE SPECIMEN WITH THE ROUGHNESS VALUE CLOSE TO THE WORKPIECE TO BE MEASURED

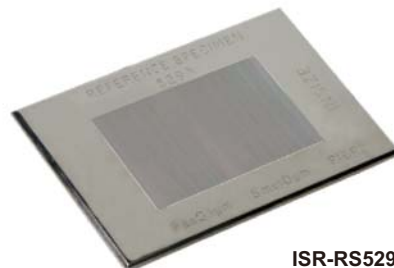

ISR-RS529X

Code	Roughness (Ra)
ISR-RS525X	6.25µm*
ISR-RS526X	3.15µm*
ISR-RS527X	3.0µm*
ISR-RS528X	0.5µm*
ISR-RS529X	0.1µm* (not suitable for ISR-S400)
ISR-RS530X	1.0µm*
ISR-RS531X	0.3µm* (not suitable for ISR-S400)

* The actual value may be slightly different

- To calibrate roughness testers
- Meets ISO 5436-1: 2000
- Rust proof, made of pure Nickel

SHOT AND GRIT BLASTING SURFACE ROUGHNESS SPECIMENS



- To check the roughness of steel surfaces which have been blast cleaned before painting
- Meets ISO 8503/1
- Rust-proof, made of pure Nickel
- Each piece contains 4 parts



ISR-CS017

Code	Machining method	Roughness (Ra)	Roughness (Rz)
ISR-CS017	Shot blasting	3.2, 8, 13, 18 μ m	19.2, 48, 78, 108 μ m
ISR-CS018	Grit blasting	3.2, 10.5, 18, 25 μ m	19.2, 63, 108, 150 μ m

COATING THICKNESS GAGE

SUITABLE FOR SMALL SURFACES, CONCAVE OR CONVEX SURFACES

FOR MAGNETIC AND NON-MAGNETIC SUBSTRATES

- Suitable for small surfaces, concave or convex surfaces
- Magnetic induction probe (Fe) is to measure the thickness of non-magnetic coating on magnetic substrate
Substrate: iron, steel, magnetic stainless steel (does not include non-magnetic stainless steel)
Coating: zinc, copper, chrome-tin, plastic powder, paint (does not include nickel)
- Eddy current probe (NFe) is to measure the thickness of non-conductive coating on non-magnetic metal substrate
Substrate: copper, aluminum, zinc, non-magnetic stainless steel
Coating: plastic powder, paint, anodizing



MAIN UNIT SPECIFICATION

Code		ISO-2000FN
Measuring range	magnetic induction probe (Fe)	0~2000 μ m
	eddy current probe (NFe)	0~800 μ m
Accuracy	$\pm(1.5+2\%L)\mu$ m L is measuring thickness in μ m	
Resolution	0.1 μ m (range<100 μ m)	
	1 μ m (range 100~1000 μ m)	
	10 μ m (range \geq 1000 μ m)	
Repeatability	1 μ m (range 0~1000 μ m)	
	10 μ m (range \geq 1000 μ m)	
Measuring mode	continuous or single	
Calibration mode	four points calibration	
Minimum substrate thickness	magnetic induction probe (Fe): 0.2mm, eddy current probe (NFe): 0.05mm	
Minimum measuring area	5x5mm, calibration should be made on workpiece without coating, test stand (optional) is recommended in order to have same position for calibration and measurement	
Power supply	2x1.5V AA batteries	
Dimension of main unit	122x65x22mm	
Weight of main unit	150g	



magnetic induction probe Fe (optional)
ISO-2000FN-FE



eddy current probe NFe (optional)
ISO-2000FN-NFE

connected to probe



main unit
ISO-2000FN



standard foil (included)

STANDARD DELIVERY

Main unit	1pc
Zero calibration block for Fe probe	1pc
Zero calibration block for NFe probe	1pc
Standard foil	7pcs
Battery (AA)	2pcs

PROBE (OPTIONAL) SPECIFICATION

Magnetic induction probe (Fe)	ISO-2000FN-FE
Eddy current probe (NFe)	ISO-2000FN-NFE

COATING THICKNESS GAGE

main unit
ISO-3000FN



probe interface

magnetic induction and eddy current integrated probe (optional)
ISO-3000FN-52DS



probe can rotate 0~90°, suitable for inclined surfaces, grooves and bore surfaces

magnetic induction probe (optional), for bores and grooves
ISO-3000FN-3T



Software for PC (included), connected to PC by wireless, upload the memory to PC

DATA OUTPUT

FOR MAGNETIC AND NON-MAGNETIC SUBSTRATES



VIDEO



- Magnetic induction probe (Fe) is to measure the thickness of non-magnetic coating on magnetic substrate
Substrate: iron, steel, magnetic stainless steel (does not include non-magnetic stainless steel)
Coating: zinc, copper, chrome, tin, plastic powder, paint (does not include nickel)
- Eddy current probe (NFe) is to measure the thickness of non-conductive coating on non-magnetic metal substrate
Substrate: copper, aluminum, zinc, non-magnetic stainless steel
Coating: plastic powder, paint, anodizing
- Low and high limits with judgement
- Two points calibration
- Memory of 10000 measurement values for browsing and output
- Power off automatically



software CD (included)

MAIN UNIT SPECIFICATION

Code	ISO-3000FN
Accuracy	±1μm (range<100μm) ±(1%L)μm (range 100~1000μm) ±(3%L)μm (range 1000~2000μm) ±(5%L)μm (range>2000μm) L is measuring thickness in μm
Resolution	0.1μm (range<100μm) 1μm (range 100~1000μm) 10μm (range>1000μm)
Repeatability	1μm (range<1000μm) 10μm (range>1000μm)
Measuring mode	single and continuous
Calibration mode	two points calibration
Minimum substrate thickness	magnetic induction (Fe): 0.3mm eddy current (NFe): 0.05mm
Output	wireless
Power supply	3×1.5V AA battery
Dimension	198×92×35mm
Weight	265g

PROBE (OPTIONAL) SPECIFICATION

Code	ISO-3000FN-52DS	ISO-3000FN-3T
Measuring range	magnetic induction probe (Fe)	0~5000μm
	eddy current probe (NFe)	0~2500μm
Minimum measuring area		Ø6mm
Minimum curvature radius of workpiece	concave	38mm
	convex	6mm
		Ø3mm
		13mm
		2mm

STANDARD DELIVERY

Main unit	1pc
Zero calibration block for Fe probe	1pc
Zero calibration block for NFe probe	1pc
USB wireless receiver and software	1pc
Standard foil	2pcs
1.5V AA battery	3pcs



USB wireless receiver (included)



standard foils (included)

OPTIONAL DELIVERY

Magnetic induction and eddy current integrated probe	ISO-3000FN-52DS
Magnetic induction probe (for bores and grooves)	ISO-3000FN-3T

COATING THICKNESS GAGE CODE ISO-5000F

probe can rotate 0~90°, suitable for inclined surfaces, grooves and bore surfaces



- Magnetic induction probe (Fe) is to measure the thickness of non-magnetic coating on magnetic substrate
Substrate: iron, steel, magnetic stainless steel (does not include non-magnetic stainless steel)
Coating: zinc, copper, chrome, tin, plastic powder, paint (does not include nickel)
- Two points calibration
- Probe can rotate 0~90°, suitable for inclined surfaces, grooves and bore surfaces
- Power off automatically

STANDARD DELIVERY

Main unit	1pc
Zero calibration block for Fe probe	1pc
Standard foil	2pcs
1.5V AA battery	1pc



standard foils (included)

FOR MAGNETIC SUBSTRATES



VIDEO



SPECIFICATION

Measuring range	0~5000μm	
Accuracy	±1μm (range<100μm) ±(1%L)μm (range 100~1000μm) ±(3%L)μm (range 1000~2000μm) ±(5%L)μm (range>2000μm) L is measuring thickness in μm	
Resolution	0.1μm (range<100μm) 1μm (range 100~1000μm) 10μm (range>1000μm)	
Repeatability	1μm (range<1000μm) 10μm (range>1000μm)	
Measuring mode	single	
Calibration mode	two points calibration	
Minimum substrate thickness	0.3mm	
Minimum measuring area	Ø8mm	
Minimum curvature radius of workpiece	concave	38mm
	convex	3mm
Power supply	1×1.5V AA battery	
Dimension	98×28×28mm	
Weight	72g	



DATA OUTPUT

FOR MAGNETIC AND NON-MAGNETIC SUBSTRATES



Software for PC (included), connected to PC by Bluetooth, upload the memory to PC



Android APP (included), connected to mobile device by Bluetooth, display measurement value and data statistics

COATING THICKNESS GAGE CODE ISO-5000FN



VIDEO

probe can rotate 0~90°, suitable for inclined surfaces, grooves and bore surfaces



- Integrated with magnetic-induction probe (Fe) and eddy current probe (NFe), switch to the suitable probe automatically according to the material to be measured
- Magnetic induction probe (Fe) is to measure the thickness of non-magnetic coating on magnetic substrate
Substrate: iron, steel, magnetic stainless steel (does not include non-magnetic stainless steel)
Coating: zinc, copper, chrome, tin, plastic powder, paint (does not include nickel)
- Eddy current probe (NFe) is to measure the thickness of non-conductive coating on non-magnetic metal substrate
Substrate: copper, aluminum, zinc, non-magnetic stainless steel
Coating: plastic powder, paint, anodizing
- Two points calibration
- Probe can rotate 0~90°, suitable for inclined surfaces, grooves and bore surfaces
- Memory of 500 measurement values for browsing and output
- Power off automatically



software CD (included)



standard foils (included)

SPECIFICATION

Measuring range	magnetic induction probe (Fe)	0~5000µm
	eddy current probe (NFe)	0~2000µm
Accuracy		±1µm (range<100µm)
		±(1%L)µm (range 100~1000µm)
		±(3%L)µm (range 1000~2000µm)
		±(5%L)µm (range>2000µm)
		L is measuring thickness in µm
Resolution		0.1µm (range<100µm)
		1µm (range 100~1000µm)
		10µm (range>1000µm)
Repeatability		1µm (range<1000µm)
		10µm (range>1000µm)
Measuring mode		single
Calibration mode		two points calibration
Minimum substrate thickness		magnetic induction probe (Fe): 0.3mm
		eddy current probe (NFe): 0.05mm
Minimum measuring area		Ø8mm
Minimum curvature radius of workpiece	concave	38mm
	convex	3mm
Output		Bluetooth
Power supply		1×1.5V AA battery
Dimension		98x28x28mm
Weight		72g

STANDARD DELIVERY

Main unit	1pc
Zero calibration block for Fe probe	1pc
Zero calibration block for NFe probe	1pc
USB wireless receiver and software	1pc
Standard foil	2pcs
1.5V AA battery	1pc

- To measure the thickness of any non-magnetic coating on magnetic substrate
substrate: steel, iron, magnetic stainless steel (non-magnetic stainless steel is not included)
coating: zinc, copper, chrome, tin, plastic, paint (nickel is not included)
- Low and high limits with judgement
- Calculate average value automatically

MEASURE NON-MAGNETIC COATING ON MAGNETIC SUBSTRATES



VIDEO

COATING THICKNESS GAGE CODE ISO-1500F



software CD (included)



zero calibration block (included)



calibration foil (included)



printer (optional)

SPECIFICATION

Measuring range		0~1500µm
Accuracy		±(2%L+2)µm L is measuring thickness in µm
Resolution		0.1µm (range<1000µm)
		1µm (range≥1000µm)
Repeatability		±1µm (range<100µm)
		±(1%L)µm (range≥100µm)
		L is measuring thickness in µm
Measuring mode		continuous and single
Calibration mode		zero calibration, one point calibration, two points calibration
Minimum substrate thickness		0.5mm
Minimum measuring area		10×10mm
Minimum curvature radius of workpiece	concave	30mm
	convex	5mm
Output		USB
Memory		1200
Power supply		3×1.5V AAA batteries (power off automatically)
Dimension		88×67×30mm
Weight		120g

STANDARD DELIVERY

Main unit	1pc
Zero calibration block	1pc
Calibration foil (50µm, 100µm, 500µm, 1000µm, 1500µm)	1set
1.5V AAA battery	3pcs
Software and USB cable	1pc

OPTIONAL ACCESSORY

Printer	ISH-DS-PRINTER
---------	----------------

MEASURE NON-MAGNETIC COATING ON MAGNETIC SUBSTRATES



eddy current probe Nfe (optional) with zero calibration block



VIDEO



zero calibration block for Fe (included)



calibration foils (included)



magnetic induction probe Fe (included)

- Magnetic induction probe (Fe, included) is to measure the thickness of non-magnetic coating on magnetic substrate: steel, iron, magnetic stainless steel (non-magnetic stainless steel is not included) coating: zinc, copper, chrome, tin, plastic, paint (nickel is not included)
- Eddy current induction probe (NFe, optional) is to measure the thickness of non-conductive coating on non-magnetic substrate: copper, aluminum, zinc, non-magnetic stainless steel coating: plastic, power, paint, anodizing
- Low and high limits with judgement
- Calculate average value automatically
- Automatic power off

COATING THICKNESS GAGE (BASIC MODEL) CODE ISO-1000F

SPECIFICATION

Probe type	Fe (included)	NFe (optional)
Measuring range	0~1250µm	
Accuracy	±(3%L+1)µm L is measuring thickness in µm	
Resolution	0.1µm (range<50µm)	
	1µm (range≥50µm)	
Repeatability	±(2%L)µm L is measuring thickness in µm	
Measuring mode	continuous and single	
Minimum substrate thickness	0.5mm	0.3mm
Minimum measuring area	Ø7mm	
Minimum curvature radius of convex workpiece	1.5mm	
	3mm	
Memory	500	
Power supply	3x1.5V AAA batteries	
Dimension	155×72×27mm	
Weight	230g	

STANDARD DELIVERY

Main unit	1pc
Magnetic induction probe (Fe)	1pc
Zero calibration block for Fe probe	1pc
Calibration foils (50µm, 100µm, 250µm, 500µm, 1000µm)	1set
1.5V AAA battery	3pcs

OPTIONAL ACCESSORY

Eddy current probe (Nfe) with zero calibration block	ISO-1000F-NFE
--	---------------



VIDEO



CROSS CUT ADHESION TESTER CODE ISQ-PK100

- To test the adhesion of paint coating on metal, wood, plastic, etc.
- According to ISO 2409, ASTM D3359, DIN53151



step 1: make grid cutting on surface



step 2: paste and remove the tape

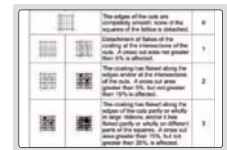

step 3: according to the shedding status, judge the adhesion grade

SPECIFICATION

Blade		1mm pitch blade	2mm pitch blade	3mm pitch blade
Applied paint thickness	hard substrate (like metal)	0~60µm	61~120µm	121~250µm
	soft substrate (like wood, plaster)	-	0~120µm	121~250µm
Minimum substrate thickness	hard substrate (like metal)	0.25mm	0.25mm	0.25mm
	soft substrate (like wood, plaster)	-	10mm	10mm
Minimum size of test sample		150×100mm	150×100mm	150×100mm
Dimension		170×28×40mm		
Weight		430g		



2X magnifier (included)



brush (included)

STANDARD DELIVERY

Handle	1pc	3mm pitch blade	1pc
1mm pitch blade	1pc	Test tape (ISQ-PK100-1)	1pc
2mm pitch blade	1pc	2X magnifier	1pc
		Brush	1pc



test tape (included) ISQ-PK100-1



1mm pitch blade (included)



2mm pitch blade (included)



3mm pitch blade (included)

PULL OFF ADHESION TESTER CODE ISQ-PF200



- To measure the pull off adhesion of paint coating on metal, wood, plastic, etc.
- According to ISO 4624, EN13144

SPECIFICATION

Test range	Ø15.1mm flat dolly	1~10Mpa
	Ø19.5mm flat dolly	2~6Mpa
Minimum size of test sample	30×30mm	
Dimension	70×70×150mm	
Weight	1kg	

STANDARD DELIVERY

Main unit	1pc
Ø15.1mm flat dolly	3pcs
Ø19.5mm flat dolly	3pcs
Ring cutter	1pc
Glue (ISQ-PF200-1)	3g
Glue for rough surface (ISQ-PF200-2)	6ml



DIGITAL SURFACE PROFILE GAGE

- Measure peak-to-valley height of blast cleaned surface. If the profile is too low, the adhesion of the coating to the surface will be reduced. If the profile is too high, there is the danger that the profile peaks will remain uncoated, allowing rust spots to occur.
- Meet ASTM D 4417-B
- Zero set block is included, set zero before measurement
- Button function: tolerance Go and No-Go display, data preset, measuring direction change, max./min./TIR measurement, inch/metric conversion, absolute/incremental measurement
- CR2032 battery, automatic power off
- Data output
- Stainless steel base
- Optional accessory: data output cable (code 7306-40, 7302-SPC3A, 7305-SPC1A)



2844-10



DATA
OUTPUT

DISPLAY MAXIMUM, MINIMUM, DIFFERENCE
VALUE BETWEEN MAXIMUM AND MINIMUM

Unit: mm

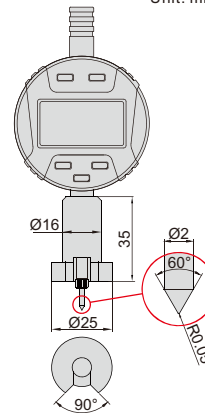

set zero



measure peak-to-valley height of blast cleaned surfaces

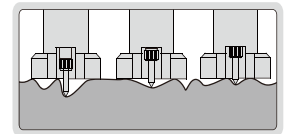

Code	Range	Digital indicator stroke	Digital indicator resolution	Accuracy
2844-10	0-12.7mm/0-0.5"	12.7mm/0.5"	0.001mm/0.00005"	±0.005mm

DIGITAL SURFACE PROFILE GAGE

- Measure peak-to-valley height of blast cleaned surface. If the profile is too low, the adhesion of the coating to the surface will be reduced. If the profile is too high, there is the danger that the profile peaks will remain uncoated, allowing rust spots to occur.
- Meet ASTM D 4417-B
- Zero set block is included, set zero before measurement
- Button function: on/off, zero, mm/inch, absolute/incremental measurement
- CR2032 battery, automatic power off
- Data output
- Stainless steel base
- Optional accessory: data output cable (code 7306-40, 7302-SPC3A, 7305-SPC1A)

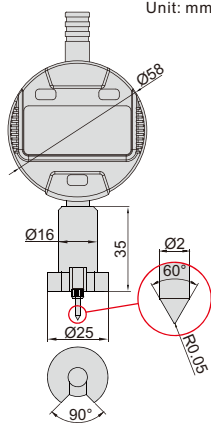

Unit: mm

set zero



measure peak-to-valley height of blast cleaned surfaces

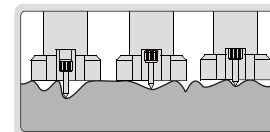

DATA
OUTPUT



2843-10

Code	Range	Digital indicator stroke	Digital indicator resolution	Accuracy
2843-10	0-12.7mm/0-0.5"	12.7mm/0.5"	0.001mm/0.00005"	±0.005mm

SURFACE PROFILE GAGE

- Measure peak-to-valley height of blast cleaned surface.
If the profile is too low, the adhesion of the coating to the surface will be reduced.
If the profile is too high, there is the danger that the profile peaks will remain uncoated, allowing rust spots to occur.
- Meet ASTM D 4417-B
- Zero set block is included, set zero before measurement
- Stainless steel base



VIDEO

measure peak-to-valley height of blast cleaned surfaces

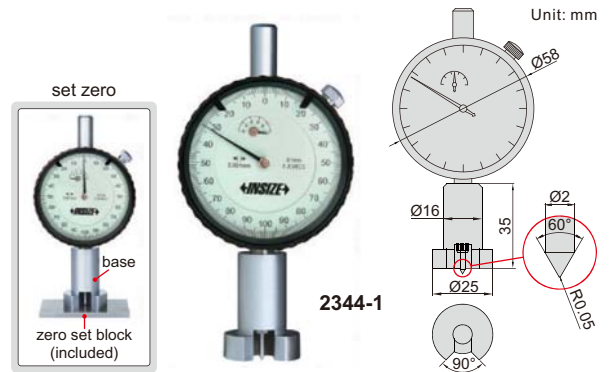
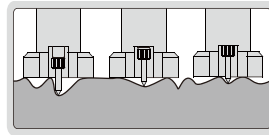

2344-1

Code	Range	Dial indicator stroke	Dial indicator graduation	Accuracy
2344-1	0-1mm	1mm	0.001mm	±0.005mm

WET FILM GAGE

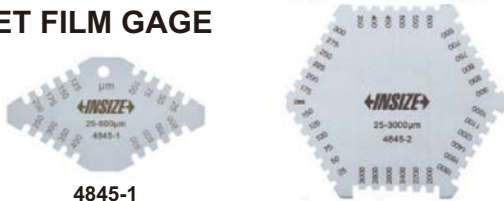

4845-1

4845-2

- Made of stainless steel

Code	Range	Accuracy	Thickness
4845-1	25-800µm	±5µm	1.8mm
4845-2	25-3000µm	25-100µm: ±5µm 100µm-3000µm: ±5%	1mm

ULTRASONIC THICKNESS GAGE (THROUGH COATING) CODE ISU-300D

- Two measuring modes, Echo-Echo (E-E) and Transmit-Echo (T-E):
 - E-E is applicable for non-metallic coating (such as paint, plastic resin, etc.) on metal substrate, can penetrate coating and measure the thickness of substrate
 - T-E is to measure the thickness of material without coating, such as metal, plastic, glass, nylon, resin, ceramics, ice, etc.
- Low and high limits with judgment
- Average calculation of maximum 9 readings
- Memory of maximum 500 readings



VIDEO

INSPECTION CERTIFICATE



PENETRATE NON-METALLIC COATING AND MEASURE THE THICKNESS OF METAL SUBSTRATE

DATA OUTPUT

software CD (included)



couplant (included)



transducer ISU-T04 (optional)



transducer ISU-T06 (optional)



transducer ISU-T12 (optional)



transducer ISU-T13 (optional)



Echo-Echo mode (E-E)

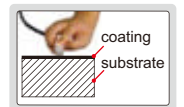

Transmit-Echo mode (T-E)

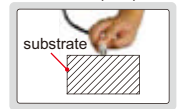

SPECIFICATION

Measuring range	E-E mode: coating thickness 0~1mm, substrate thickness 4~25mm
	T-E mode: substrate thickness 1.5~200mm
Resolution	0.01mm (range<100mm) 0.1mm (range≥100mm)
Repeatability	0.03mm (range<100mm) 0.1mm (range≥100mm)
Accuracy	±0.04mm (range<10mm) ±(0.04+H/1000)mm (range 10~100mm) ±H/333mm (range≥100mm) H is the thickness to be measured in mm
Velocity	1000~9999m/s
Power supply	2×1.5V AAA batteries
Dimension	116×64×27mm
Weight	220g

STANDARD DELIVERY

Main unit	1pc
Transducer ISU-T07	1pc
Battery (AAA)	2pcs
Couplant (for ISU-T04, ISU-T06, ISU-T07, ISU-T12)	1bottle
USB cable and software disc	1pc

OPTIONAL ACCESSORY

Transducer	ISU-T04, ISU-T06, ISU-T12, ISU-T13
Couplant (for ISU-T13)	ISU-HT5-COUPPLANT

SPECIFICATION OF TRANSDUCERS

Code	Mode	Frequency	Diameter (Ød)	Measuring range	Minimum size of pipe for measurement (diameter × wall thickness)	Applicable temperature	Application
ISU-T07	T-E E-E	5.0MHz	10.8mm	T-E mode: 1.5~200mm E-E mode: 4~25mm	T-E mode: 20×1.2mm E-E mode: 20×4mm	<60°C	general use
ISU-T04	T-E	10.0MHz	6mm	0.7~20mm	10×1mm	<60°C	for small tube
ISU-T06	T-E	7.5MHz	8.5mm	0.7~50mm	15×1.2mm	<60°C	for thin material
ISU-T12	T-E	2.0MHz	16.3mm	2~400mm	30×4mm	<60°C	for casting iron
ISU-T13	T-E	5.0MHz	13mm	2~200mm	25×3mm	<350°C	for high temperature

ULTRASONIC THICKNESS GAGE CODE ISU-250C

**INSPECTION
CERTIFICATE**

**DATA
OUTPUT**



VIDEO

- Measure the thickness from one side of object, suitable for pipe, tank, etc.
- Applicable material: metal, plastic, glass, nylon, resin, ceramic, ice
- Low and high limits with judgement
- Average calculation of maximum 9 readings
- Memory of maximum 5000 readings with location number



software CD (included)



4.00mm block for calibration

LCD with backlight

USB port

transducer ISU-T08

∅d



couplant (included)



transducer ISU-T04 (optional)



transducer ISU-T06 (optional)



transducer ISU-T12 (optional)



transducer ISU-T13 (optional)

SPECIFICATION

Resolution	0.01mm (range<100mm)
	0.1mm (range≥100mm)
Repeatability	0.03mm (range<100mm)
	0.1mm (range≥100mm)
Accuracy	±0.04mm (range<10mm)
	±(0.04+H/1000)mm (range 10~100mm)
	±H/333mm (range≥100mm)
	H is the thickness to be measured in mm
Velocity	1000-9999m/s
Power supply	2×1.5V AAA batteries
Dimension	64×116×27mm
Weight	220g

STANDARD DELIVERY

Main unit	1pc
Transducer ISU-T08	1pc
Battery (AAA)	2pcs
Couplant (for ISU-T04, ISU-T06, ISU-T08, ISU-T12)	1bottle
USB cable and software disc	1pc

OPTIONAL ACCESSARY

Transducer	ISU-T04, ISU-T06, ISU-T12, ISU-T13
Couplant (for ISU-T13)	ISU-HT5-COUPPLANT

SPECIFICATION OF TRANSDUCERS

Code	Frequency	Diameter (∅d)	Measuring range	Minimum size of pipe for measurement (diameter × wall thickness)	Applicable temperature	Application
ISU-T08	5.0MHz	10.8mm	0.8~300mm	20×1.2mm	<60°C	general use
ISU-T04	10.0MHz	6mm	0.7~20mm	10×1mm	<60°C	for small tube
ISU-T06	7.5MHz	8.5mm	0.7~50mm	15×1.2mm	<60°C	for thin material
ISU-T12	2.0MHz	16.3mm	2~400mm	30×4mm	<60°C	for casting steel
ISU-T13	5.0MHz	13mm	2~200mm	25×3mm	<350°C	for high temperature

ULTRASONIC THICKNESS GAGE (BASIC MODEL) CODE ISU-100D

- Measure the thickness from one side of object, suitable for pipe, tank, etc.
- Applicable material: metal, plastic, glass, nylon, resin, ceramic, ice



SPECIFICATION

Measuring range	0.8~300mm	
Resolution	0.01mm (range<100mm)	
	0.1mm (range≥100mm)	
Accuracy	±0.04mm (range<10mm)	
	±(0.04+H/1000)mm (range 10~100mm)	
	±H/333mm (range≥100mm)	
	H is the thickness to be measured in mm	
Transducer	frequency	5MHz
	diameter (∅d)	10.8mm
Minimum size of pipe for measurement	20×1.2mm (diameter × wall thickness)	
Applicable temperature	<60°C	
Velocity	1000-9999m/s	
Power supply	2×AAA batteries	
Dimension	114×64×28mm	
Weight	200g	

ATTENTION: NOT SUITABLE FOR CASTING WORKPIECES

**INSPECTION
CERTIFICATE**



VIDEO



LCD with backlight

4.00mm calibration block

∅d

STANDARD DELIVERY

Main unit	1pc
Transducer	1pc
Couplant	1bottle
Battery (AAA)	2pcs

proximity trigger (included)

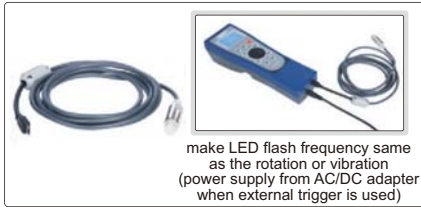

make LED flash frequency same as the rotation or vibration (power supply from AC/DC adapter when external trigger is used)

DIGITAL LED TACHOMETER/STROBOSCOPE CODE ISQ-TS120K



- Make cyclical motion (rotation, vibration, etc.) objects to appear slow-moving or stationary
- On-line inspection or observation for moving objects
- Measure the rotation or vibration speed and frequency
- Can be triggered from outside by moving objects, make LED flash frequency same as the rotation or vibration

SPECIFICATION

Flash frequency range	60~120000FPM (Flash Per Minute), 1~2000Hz	
Resolution	FPM	0.1FPM (<100000FPM), 1FPM (≥100000FPM)
	HZ	0.01Hz (<200Hz), 0.1Hz (≥200Hz)
Setting accuracy	±0.01%	
Phase shift increment	3°	
Flash pulse duration time	0.1~2.5°	
LED light	3pcs CREE 10W lamp	
LED life	3~5 years	
Trigger mode	internal and external	
Power supply	built-in rechargeable battery or AC/DC adapter	
Dimension	208×70×60mm	
Weight	380g	

STANDARD DELIVERY

Main unit	1pc
AC/DC adapter	1pc
Proximity trigger	1pc

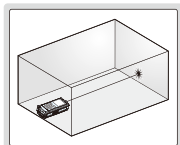

distance measurement

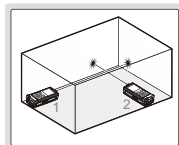

area measurement

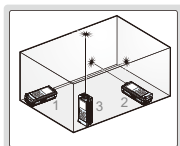

volume measurement

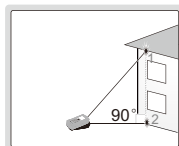

height measurement

LASER DISTANCE METER CODE ISN-L70



IP52
WATERPROOF



SPECIFICATION

Measuring range	0.05~70m
Accuracy	±1.5mm
Resolution	1mm
Measuring speed	0.5 second
Dust/waterproof	IP52
Laser type	650nm, Class II, <1mW
Beam size	25mm@30m
Memory	20 measuring data
Power supply	2xAA batteries, for 10000 measurements
Dimension (L×W×H)	110×45×30mm
Weight	130g

- Large display with backlight
- Unit: m, ft, in
- Distance, area, volume and height measurement
- With continuous measuring mode to track maximum and minimum value
- Automatic power-off: laser 30s, main unit 180s

STANDARD DELIVERY

Main unit	1pc
Battery (AA)	2pcs
Strap	1pc
Carrying bag	1pc

LASER DISTANCE METER CODE 9561-80

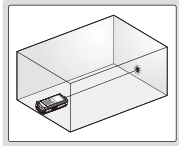

distance measurement

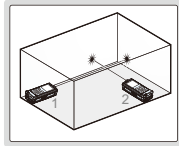

area measurement

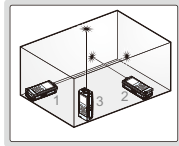

volume measurement

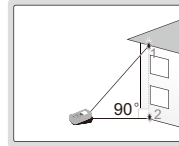

height measurement

- Large display with backlight
- Unit: m, ft, in
- Distance, area, volume and height measurement
- Continuous measuring mode to track maximum and minimum value
- Memory of 99 measurement values
- Automatic power off: laser 20s, main unit 150s

SPECIFICATION

Measuring range	0.05 ~ 80m
Accuracy	±3mm
Resolution	1mm, 10mm, 0.1", 0.01ft
Measuring speed	0.5 second
Laser type	635nm, Class II, <1mW
Power supply	3×AAA batteries, for 4000 measurements
Dimension (L×W×H)	120×60×28mm
Weight	175g



STANDARD DELIVERY

Main unit	1pc
Battery (AAA)	3pcs

INFRARED THERMOMETER CODE 9110-500



- Fast measurement with infrared or k-type sensor
- Maximum, minimum, average and difference modes
- Low and high limits with judgement
- Memory 20 measurement values
- Automatic power off

SPECIFICATION

Measuring range	infrared	-60~500°C/-76~932°F
	k-type sensor	-40~1080°C/-40~1976°F
Accuracy	infrared	±(1.5%+2)°C/±(1.5%+4)°F
	k-type sensor	±(1%+2)°C/±(1%+4)°F
Resolution		0.1°C/0.1°F (range<199.9), 1°C/1°F (range>199.9)
Distance to spot ratio (D:S)		12:1
Emissivity		0.1 ~ 1 (adjustable)
Laser type		630 ~ 670nm, Class II, <1mW
Response time		<500ms
Power supply		9V battery
Dimension		176×132×49mm
Weight		223g

STANDARD DELIVERY

Main unit	1pc
K-type sensor	1pc
9V battery	1pc



k-type sensor (included)





DATA
OUTPUT



software (included), display measurement values and graph, save and output data

DIGITAL ANEMOMETER CODE 9331-40



software CD
(included)

- Measure velocity, flow, temperature and relative humidity
- Velocity unit: m/s, km/h, mil/h, ft/m, ft/s, knots
- Flow unit: CMS (cubic meter per second), CMM (cubic meter per minute), CFM (cubic feet per minute)
- Temperature type: ambient, dew point, wet bulb
- Maximum and minimum modes
- Automatic power off

SPECIFICATION

Measuring range	velocity	0.8~30m/s, 1.4~108km/h, 0.9~67.2mil/h, 1.3~98.5ft/s, 78~5900ft/m, 0.8~58.3knots
	flow	0~9999CMS, 0~99990CMM, 0~99990CFM
	temperature	-20~60°C/-4~140°F
	relative humidity	0~100%RH
Accuracy	velocity	±(2%+0.5) for m/s, km/h, mil/h, ft/s, knots ±(2%+50) for ft/m
	temperature	±1.5°C/±2.7°F
	relative humidity	±3% (20~80%RH), ±5% (<20%RH or >80%RH)
Resolution	velocity	0.01m/s, 0.01km/h, 0.01mil/h, 0.01ft/s, 1ft/m, 0.01knots
	flow	0.01CMS, 0.1CMM, 0.1CFM
	temperature	0.1°C/0.1°F
	relative humidity	0.1%RH
Flowing area range	0~9.999m²/0~9.999ft²	
Sampling time	0.4s	
Maximum working height	2000m	
Output	USB	
Power supply	9V battery	
Dimension	165×85×38mm	
Weight	200g	

STANDARD DELIVERY

Main unit	1pc
USB cable and software	1pc
9V battery	1pc



cover (included)



- Suitable for wood, smooth cement, hard gypsum, mixed mortar, brick, etc.
- Measure moisture, temperature and relative humidity
- Temperature type: ambient, dew point, wet bulb
- Maximum and minimum modes
- Automatic power off

SPECIFICATION

Measuring depth	0~50mm	
Measuring range	Moisture	0~60%
	temperature	-10~50°C/14~122°F
	relative humidity	0~100%RH
Accuracy	Moisture	±2%
	temperature	±2%
	relative humidity	±5%RH
Resolution	Moisture	0.1%
	temperature	0.1°C/0.1°F
	relative humidity	0.1%RH
Sampling time	0.5s for moisture	
	1s for temperature and relative humidity	
Power supply	2×AAA batteries	
Dimension	130×56×29mm	
Weight	206g	

DIGITAL MOISTURE METER CODE 9341-50



STANDARD DELIVERY

Main unit	1pc
Battery (AAA)	2pcs

DIGITAL SOUND LEVEL METER CODE 9351-130

- Automatically select best range: 30~80dB, 40~90dB, 50~100dB, 60~110dB, 70~120dB, 80~130dB
- Over range indicator
- Real time, average, maximum modes
- Memory 16000 measurement values
- AC signal output: 0.707 Vrms at FS, impedance approx. 600Ω
- DC signal output: 10mV/dB, impedance approx. 100Ω
- Automatic power off

SPECIFICATION

Measuring range	30~130dB
Accuracy	±2dB
Resolution	0.1dB
Sampling time	0.5s for digital, 0.05s for analogue
Response time	fast: 125ms, slow: 1s
Frequency	30Hz~8KHz
Frequency weighting	A/C
Microphone	electret condenser type
Output	RS232, AC/DC
Power supply	6×AAA batteries
Dimension	265×80×69mm
Weight	317g



software CD
(included)



DATA
OUTPUT

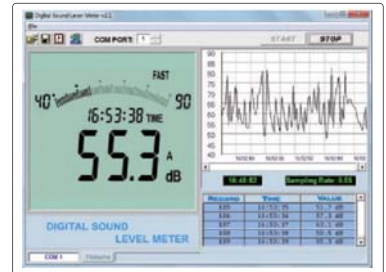

software (included), display measurement values and graph, save and output data

STANDARD DELIVERY

Main unit	1pc
RS232 cable and software	1pc
Output connector	1pc
Battery (AAA)	6pcs

NON-CONTACT DIGITAL TACHOMETER CODE 9221-999

- Maximum and minimum modes
- Memory 100 measurement values
- Automatic power off

SPECIFICATION

Measuring range	50~99999RPM
Accuracy	±(0.03%+2) RPM
Resolution	0.01RPM (range 50~99.99RPM)
	0.1RPM (range 100~9999.9RPM)
	1RPM (range 10000~99999RPM)
Measuring distance	50~250mm
Power supply	4×AAA batteries
Dimension	155×60×27mm
Weight	118g



reflection sticker (included)

STANDARD DELIVERY

Main unit	1pc
Reflection sticker	1roll
Battery (AAA)	4pcs



CONTACT DIGITAL TACHOMETER CODE 9222-199

- Unit: RPM, m/min, m/sec, ft/min, ft/sec, in/min
- Maximum and minimum modes
- Memory 100 measurement values
- Automatic power off



wheel with 0.1m
perimeter (included)



wheel with 6"
perimeter (included)



cone cavity head
(included)



cone head
(included)



Extension rod
(included)

SPECIFICATION

Measuring range	50~19999RPM
Accuracy	±(0.03%+2) RPM
Resolution	0.01RPM (range 50~99.99RPM)
	0.1RPM (range 100~9999.9RPM)
	1RPM (range 10000~19999RPM)
Power supply	4×AAA batteries
Dimension	183×60×27mm
Weight	122g

STANDARD DELIVERY

Main unit	1pc
Wheel with 0.1m perimeter	1pc
Wheel with 6 inch perimeter	1pc
Cone cavity head	1pc
Cone head	1pc
Extension rod	1pc
Battery (AAA)	4pcs





VIDEO

60° GLOSS METER CODE ISQ-DG6

- To test the gloss of coating, such as painting, varnish, printing ink, etc.
- To test the material surfaces, such as metal, granite, ceramic, plastic, paper, etc.
- According to ISO 2813, ASTM D2457, ASTM D523
- Automatic power off

SPECIFICATION

Incidence angle	60°
Measuring range	0~150GU
Resolution	0.1GU
Accuracy	±1.2GU
Repeatability	0.4GU
Zero set error	0.2GU
Measuring area	20×10mm
Power supply	1×1.5V AA battery
Dimension	123×38×65mm
Weight	300g



base with calibration block
(included)

STANDARD DELIVERY

Main unit	1pc
Base with calibration block	1pc
Spare calibration block	1pc

DATA
OUTPUT



VIDEO

- To test the gloss of coating, such as painting, varnish, printing ink, etc.
- To test the material surfaces, such as metal, granite, ceramic, plastic, paper, etc.
- According to ISO 2813, ASTM D2457, ASTM D523
- Memory of 10000 measurement results for browsing and output
- Automatic power off

SPECIFICATION

Incidence angle	20°	60°	85°
Measuring range	0~2000GU	0~1000GU	0~160GU
Resolution	0.1GU (range≤119.9GU)		
	1GU (range>119.9GU)		
Accuracy	±1.5GU (range≤119.9GU)		
	±1.5% (range>119.9GU)		
Repeatability	0.2GU (range≤119.9GU)		
	0.2% (range>119.9GU)		
Zero set error	0.2GU		
Measuring area	10×9mm	16×9mm	39×5mm
Power supply	1×1.5V AA battery		
Dimension	155×48×75mm		
Weight	400g		



20°/60°/85° GLOSS METER CODE ISQ-DG8



base with calibration block
(included)



software CD
(included)

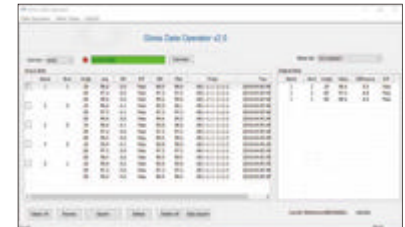

software (included), output to Excel

STANDARD DELIVERY

Main unit	1pc
Base with calibration block	1pc
USB cable and software	1pc

SUITABLE FOR WATER
BASED COOLANT

- Quickly measure the concentration of coolant
- Refer to the refraction factor of coolant, for example: the refraction factor of grinding emulsion is 2.1, the reading value is 6%, so the actual concentration is $(2.1 \times 6\%) = 12.6\%$

SPECIFICATION

Measuring range	0~32%
Graduation	0.2%
Dimension	27×40×160mm
Weight	175g



VIDEO

PORTABLE REFRACTOMETER CODE ISQ-RM30



EXTERNAL THREAD MEASURING DEVICE CODE ISQ-TE100

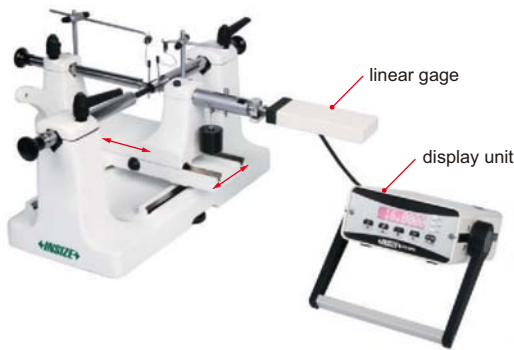

- Quickly measure major, pitch and minor diameters of external thread
- Suitable for metric, inch, Whitworth, NPT and BSPT

measure pitch diameter of thread

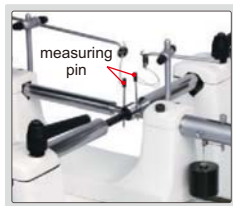

Measuring pin (optional)

- To measure pitch diameter of external thread
- Each size is supplied in pair
- Hardness: 60±2HRC



Code	Pins included	Pin diameter (mm)
ISQ-TE100-A	21 pairs	0.170, 0.195, 0.220, 0.250, 0.290, 0.335, 0.390, 0.455, 0.530, 0.620, 0.725, 0.895, 1.100, 1.350, 1.650, 2.050, 2.550, 3.200, 4.000, 5.050, 6.350

Female center (optional)

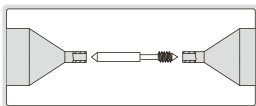

- With small holes to support small workpieces without female centers
- Supplied in pair

Code
ISQ-TE100-C

Find pointer (optional)

- To find measuring point of NPT or BSPT



Code	Angle β	Applicable thread
ISQ-TE100-F	60°	NPT
ISQ-TE100-G	55°	BSPT

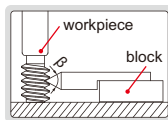

Display unit (optional)

Code	7108-1*
Display	8 digits
Character height	9mm
Dust/waterproof	IP20
Resolution	0.1μm



7108-1

* Refer to 7108-1 for details

Code	Range	Resolution	Accuracy	Repeatability
ISQ-TE100	0-100mm	0.1μm	2μm	0.5μm

OPTIONAL ACCESSORY

Measuring pin	ISQ-TE100-A
Measuring prism	ISQ-TE100-B
Female center	ISQ-TE100-C
Clamp	ISQ-TE100-D
Setting disc	ISQ-TE100-E
60° find pointer	ISQ-TE100-F
55° find pointer	ISQ-TE100-G
Display unit	7108-30
Linear gage	7108-1

Setting disc (optional)

- To set initial value



Code	Discs included	Disc diameter (mm)
ISQ-TE100-E	22 pcs	3, 5, 8, 12, 16, 20, 24, 30, 35, 40, 45, 50, 55, 60, 65, 70, 75, 80, 85, 90, 95, 100

Measuring prism (optional)

- To measure minor diameter of external thread
- Each size is supplied in pair



Code	Prisms included	Size
ISQ-TE100-B	4 pairs	A, B, C, D (for different types and sizes of thread)

Clamp (optional)

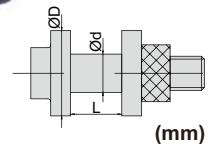
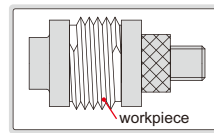

- To hold large workpieces with inner bore

Code	Clamps included	d	D	L
ISQ-TE100-D	3 pcs	13.5	30	0-18
		23	60	0-18
		23	75	0-18

Linear gage (optional)

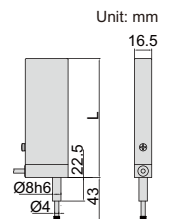

Code	7108-30*
Measuring range	30mm
Resolution	0.01μm
Accuracy	(0.5+L/60)μm L is measuring length in mm
Dust/waterproof	IP50

* Refer to 7108-30 for details



ELECTRONIC LEVEL CODE ISE-L051

DATA
OUTPUT

SHOCK
PROOF

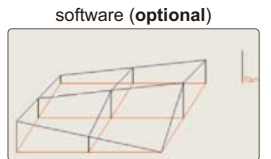

measure flatness of surface plates

- Shockproof
- Analogue and digital reading modes

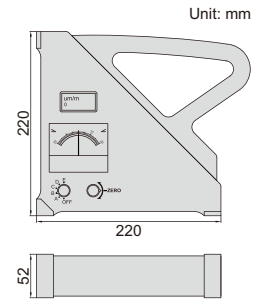
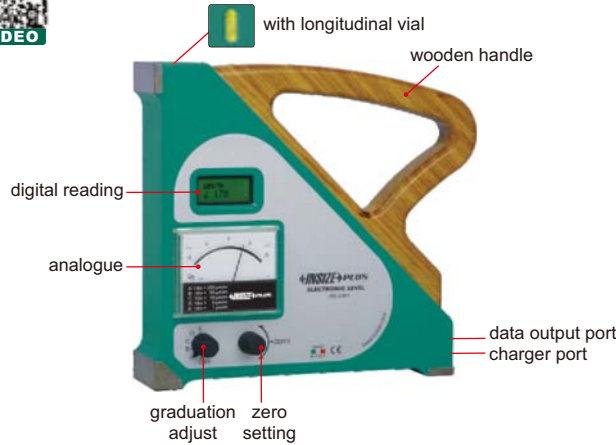

SPECIFICATION

Graduation of analogue reading	250µm/m(=0.014°)	50µm/m(=10")	10µm/m(=2")	5µm/m(=1")	1µm/m(=0.2")
Range of analogue reading	5000µm/m	1000µm/m	200µm/m	100µm/m	20µm/m
Resolution of digital reading	1µm/m(=0.2")				
Range of digital reading	5000µm/m				
Accuracy	±2%				
Range of zero setting	±1500µm/m				
Response time	<3 sec				
Data output	RS232				
Power supply	rechargeable battery, for 100 hours working				
Dimension	220x220x52mm				
Weight	4.4kg				

STANDARD DELIVERY

Main unit	1pc
AC/DC adapter	1pc

OPTIONAL ACCESSORY

USB Cable and software	ISE-L050-SOFTWARE
------------------------	-------------------

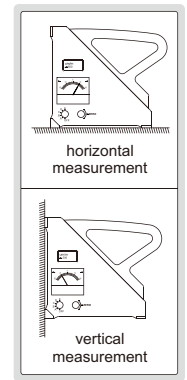

ELECTRONIC LEVEL CODE ISE-L050

DATA
OUTPUT

SHOCK
PROOF

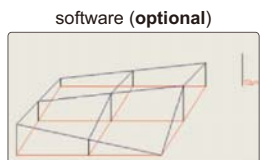

measure flatness of surface plates

- Shockproof

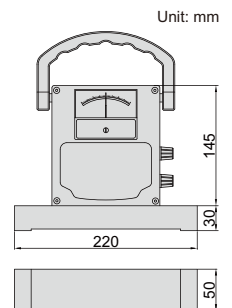
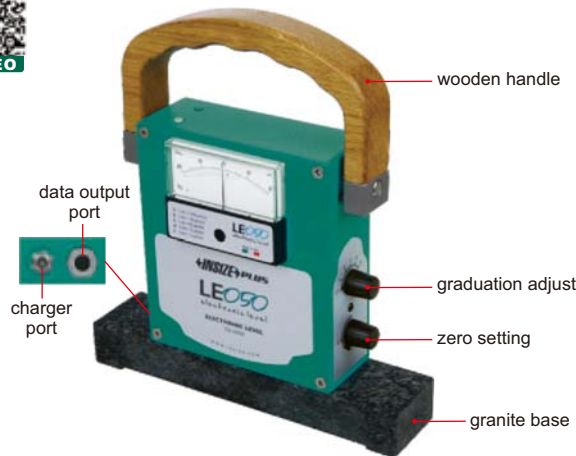

SPECIFICATION

Graduation (adjustable)	250µm/m(=0.014°)	50µm/m(=10")	10µm/m(=2")	5µm/m(=1")	1µm/m(=0.2")
Range	5000µm/m	1000µm/m	200µm/m	100µm/m	20µm/m
Accuracy	±2%				
Range of zero setting	±1500µm/m				
Response time	<3 sec				
Data output	RS232				
Power supply	rechargeable battery, for 100 hours working				
Dimension	220x236x50mm				
Weight	2.8kg				

STANDARD DELIVERY

Main unit	1pc
AC/DC adapter	1pc

OPTIONAL ACCESSORY

USB Cable and software	ISE-L050-SOFTWARE
------------------------	-------------------

DIGITAL LEVEL CODE ISE-2DT



- Color LCD, touch panel
- X-Y axis measurement
- Set the tolerance and the display is shown in different colors



within the tolerance (green) slightly out of the tolerance (yellow) seriously out of the tolerance (red)

- To show the incline with line or bubble

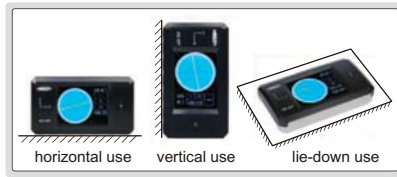

absolute/incremental mode

angle of incline

DATA OUTPUT

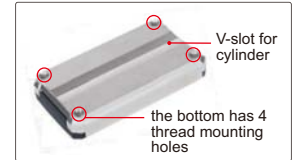
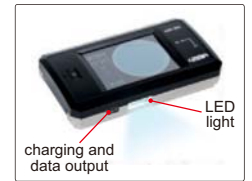

SPECIFICATION

Measuring range	±30°
Resolution	0.01°, 0.1mm/m
Accuracy	±0.03° (range 0~3°) ±0.05° (range >3°)
Power supply	rechargeable battery
Dimension	115×66×23mm
Weight	224g

STANDARD DELIVERY

Main unit	1pc
USB cable	1pc

OPTIONAL ACCESSORY

Software	ISE-2DT-SOFTWARE
----------	------------------

DIGITAL LEVEL AND PROTRACTOR

- IP67 WATERPROOF
- ABSOLUTE LEVEL
- BACKLIGHT
- BUZZER ALARM AT 0° AND 90°

- IP67 dust/waterproof
- Aluminum frame, shock absorbing rubber end caps
- Magnetic bottom with V-groove for shafts
- The sea level is permanently set inside the chip, zero setting is not needed when batteries are replaced
- Buttons: ON/OFF, backlight/buzzer alarm, absolute and incremental measurement, unit (mm/m, %, °), HOLD (keep the reading)
- Three AAA batteries
- Automatic power off



2175-360

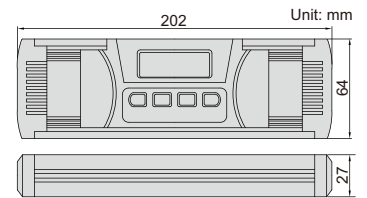

Code	Range	Resolution	Accuracy
2175-360	0-360° (90°x4)	0.05° (=0.873mm/m)	0°: ±0.05°; others: ±0.1°

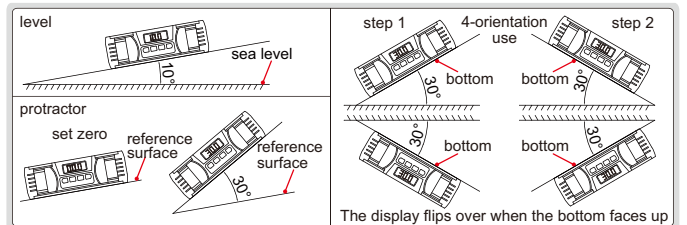

DIGITAL LEVEL AND PROTRACTOR

- IP54 WATERPROOF
- ABSOLUTE LEVEL
- BACKLIGHT
- BUZZER ALARM AT 0° AND 90°



2179-360

Code	Range	Resolution	Accuracy
2179-360	0-360° (90°x4)	0.05° (=0.873mm/m)	0° and 90°: ±0.1°; others: ±0.2°

- IP54 dust/waterproof
- Aluminum frame
- Magnetic bottom with V-groove for shafts
- The sea level is permanently set inside the chip, zero setting is not needed when batteries are replaced
- Buttons: ON/OFF, absolute and incremental measurement, keep the reading, buzzer alarm, unit (mm/m, %, in/ft), backlight
- Two AAA batteries
- Automatic power off

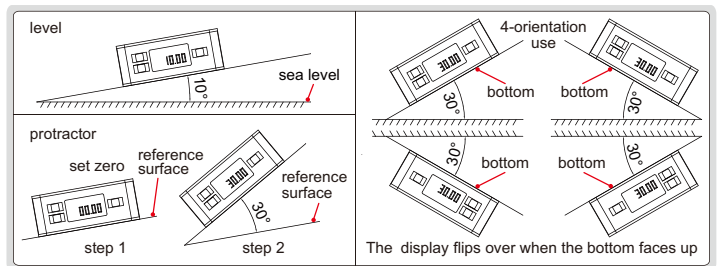
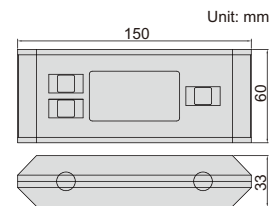

- BACKLIGHT
- ABSOLUTE LEVEL
- MAGNETIC BOTTOM
- DISPLAY FLIPS OVER WHEN THE BOTTOM FACES UP



DIGITAL LEVEL AND PROTRACTOR

- Aluminum frame
- Magnetic bottom
- The display flips over when the bottom faces up
- The backlight is on automatically when in use, and automatically off in 15 minutes after use
- The sea level is permanently set inside the chip, zero setting is not needed when battery is replaced
- Buttons: ON/OFF, ZERO, absolute and incremental measurement
- One AAA battery
- Automatic power off in 5 minutes

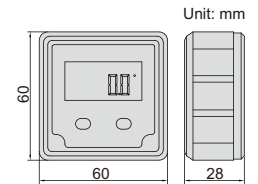

2170-1

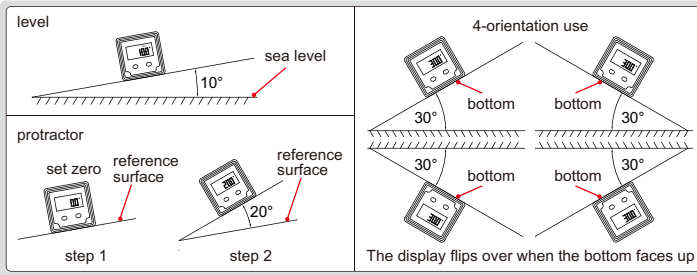

Code	Range	Resolution	Accuracy
2170-1	4x90°	0.1° (=1.745mm/m)	at 0° and 90°: ±0.1°; others: ±0.2°



NO NEED TO SET ZERO BEFORE USE

- No need to set zero before use
- Three V-grooves for shafts (shafts dia. 19.3~115.9mm)
- With longitudinal vial

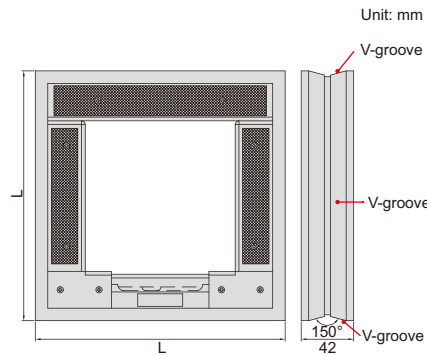

4906-200

Code		Size (LxL)
Sensitivity 0.02mm/m (=0.001°)	Sensitivity 0.1mm/m (=0.0057°)	
4906-150	4906-B150	150x150mm
4906-200	4906-B200	200x200mm
4906-300	4906-B300	300x300mm

ATTENTION: BASIC MODEL



- V-groove on bottom and left for shafts (shafts dia. 15~70mm)
- With transverse vial
- Supplied with adjusting wrench

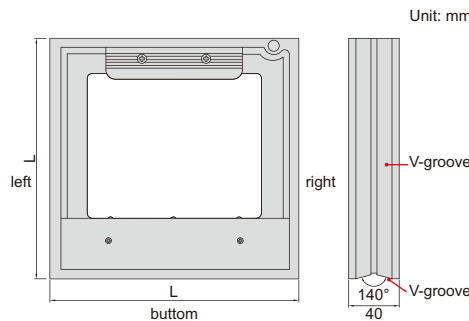

4902-200

Code		Size (LxL)
Sensitivity 0.02mm/m (=0.001°)	Sensitivity 0.05mm/m (=0.0029°)	
4902-150	4902-C150	150x150mm
4902-200	4902-C200	200x200mm
4902-300	4902-C300	300x300mm

BLOCK LEVELS

- No need to set zero before use
- V-groove on bottom for shafts (shafts dia. 19.3~115.9mm)
- With longitudinal vial



4905-200

NO NEED TO SET ZERO BEFORE USE



Code		Size (L)
Sensitivity 0.02mm/m(=0.001°)	Sensitivity 0.1mm/m(=0.0057°)	
4905-160	4905-B160	160mm
4905-200	4905-B200	200mm
4905-300	4905-B300	300mm
4905-500	4905-B500	500mm

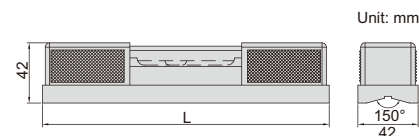

BLOCK LEVELS



- V-groove on bottom for shafts (shafts dia. 15~70mm)
- With transverse vial
- Supplied with adjusting wrench



4903-200A

ATTENTION: BASIC MODEL

Code		Length (L)	B	C
Sensitivity 0.02mm/m (=0.001°)	Sensitivity 0.05mm/m (=0.0029°)			
4903-150A	4903-C150	150mm	40	45
4903-200A	4903-C200	200mm	42	47
4903-300A	4903-C300	300mm	45	50

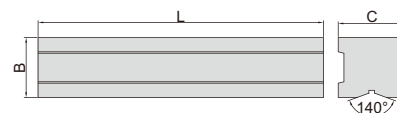

SHORT LEVEL

- No need to set zero before use
- Suitable for small spaces like crankshaft
- Longitudinal and transverse V-grooves on bottom for shafts (shafts dia. 19.3~115.9mm)
- With transverse vial



4907-90

NO NEED TO SET ZERO BEFORE USE



Code	Length	Sensitivity
4907-90	90mm	0.1mm/m(=0.0057°)

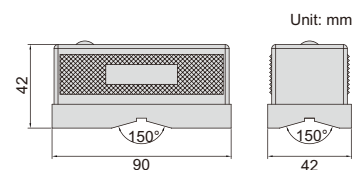

MINI LEVEL

- No need to set zero before use
- With mounting holes (for M5 screws)



4908-100

NO NEED TO SET ZERO BEFORE USE



Code	Length	Sensitivity
4908-100	100mm	0.1mm/m(=0.0057°)

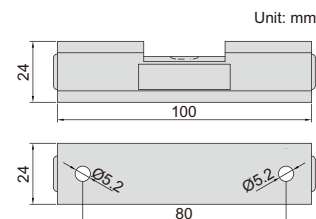

DIGITAL LEVEL

ABSOLUTE LEVEL

BACKLIGHT

BUZZER ALARM AT 0° AND 90°

- With transverse and longitudinal vials
- Used as level and protractor
- Aluminum frame
- Magnetic bottom
- The sea level is permanently set inside the chip, zero setting is not needed when batteries are replaced
- Buttons: ON/OFF, absolute and incremental measurement, keep the reading, buzzer alarm, unit (mm/m, %, in/ft) conversion, backlight
- The display flips over when the bottom faces up
- Two AAA batteries
- Automatic power off



4910-600

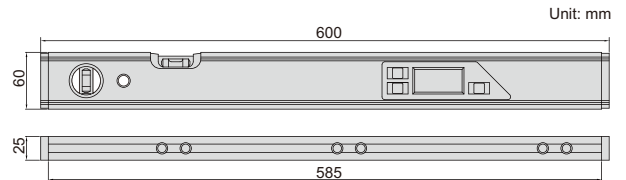

Code	Range	Resolution	Accuracy
4910-600	0-360° (90°x4)	0.1° (=1.745mm/m)	0° and 90°: ±0.1°; others: ±0.2°

ALUMINUM ALLOY LEVELS

- Die casting aluminum alloy frame
- With three vials: 180°, 90° and 45°
- Zero position of vial 180° can be set



4911-600

Code	Length (L)	Accuracy
4911-400	400mm	0.75mm/m
4911-600	600mm	0.75mm/m
4911-800	800mm	0.75mm/m

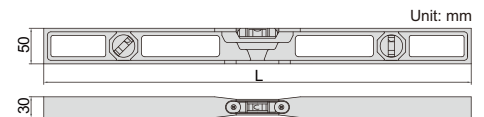

MAGNETIC BASE

VIALS MADE IN ISRAEL
LIFETIME WARRANTY

- Shockproof vials
- Magnetic base
- Shock absorbing rubber end caps
- Working temperature: -15°C ~ 55°C

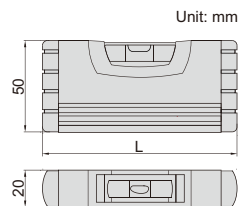

packaging



4912-100

Code	Size (L)	Accuracy
4912-100	100mm	0.5mm/m (.006in/ft)

CAST ALUMINUM LEVEL

MAGNETIC BASE

VIALS MADE IN ISRAEL
LIFETIME WARRANTY

- Shockproof horizontal and vertical vials
- Magnetic base
- Working temperature: -15°C~55°C
- Cast aluminum body

packaging



4913-250

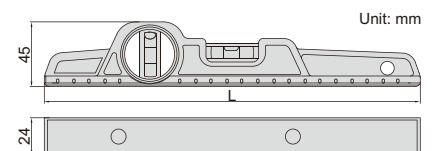

Code	Size (L)	Accuracy
4913-250	250mm	0.5mm/m (.006in/ft)

ALUMINUM LEVELS

MAGNETIC BASE

VIALS MADE IN ISRAEL
LIFETIME WARRANTY

- Shockproof horizontal and vertical vials
- Magnetic base
- Shock absorbing rubber end caps
- Working temperature: -15°C~55°C



4914-600

Code	Size (L)	Accuracy
4914-600	600mm	0.5mm/m (.006in/ft)
4914-800	800mm	0.5mm/m (.006in/ft)
4914-1000	1000mm	0.5mm/m (.006in/ft)
4914-1200	1200mm	0.5mm/m (.006in/ft)

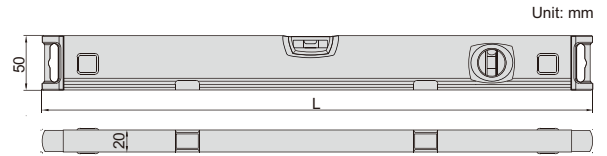

AUTOMATIC DIGITAL ROCKWELL HARDNESS TESTER CODE ISH-RSR400**

INSPECTION
CERTIFICATE

FORCE LOADING BY ELECTRIC
MOTOR (WITHOUT WEIGHTS)

DATA
OUTPUT



VIDEO

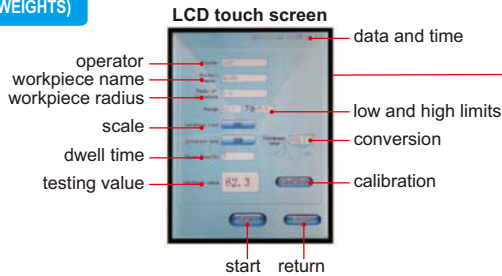

- Automatic testing, the preliminary and main test force is loaded automatically
- LCD touch screen, easy operation
- Convert to other Rockwell scales, HV or HB automatically
- Low and high limits
- Insert USB flash disk, save the testing results as Excel
- Self-correcting the hardness value for curved workpiece
- Force loading by electric motor (without weights)
- The test force is selected automatically according to hardness scale

SPECIFICATION

Hardness scale	HRA, HRB, HRC, HRD HRF, HRG (with standard indenters)
	HRE, HRH, HRK, HRL, HRM, HRP HRR, HRS, HRV (with optional indenter)
Preliminary test force	98N
Test force	588N, 980N, 1471N
Stage elevation	manual
Load control	automatic (load/dwell/unload)
Load dwell time	0~60 second
Resolution	0.1HR
Output	USB
Max. workpiece height	220mm
Max. workpiece depth	200mm (from the center of indenter)
Power supply	220V, 50/60Hz **
Dimension	510×260×780mm
Weight	70kg

** Add "-U" on code No. when power supply is 110V, 50/60Hz

STANDARD DELIVERY

Main unit	1pc
Ø63mm flat anvil	1pc
Ø150mm flat anvil	1pc
V-type anvil	1pc
Diamond indenter	1pc
Ø1.5875mm carbide ball indenter	1pc
Hardness test block HRB88~95	1pc
Hardness test block HRC60~65	1pc
Hardness test block HRC20~30	1pc
USB flash disk (8G)	1pc
Level	1pc
Touch pen	1pc
Anti-dust cover	1pc

OPTIONAL ACCESSORY

Hardness test block HRB88~95	ISH-BHRB
Hardness test block HRC60~65	ISH-BHRC3
Hardness test block HRC20~30	ISH-BHRC1
Small V-type anvil	ISH-SMALL ANVIL

FORCE LOADING BY ELECTRIC MOTOR (WITHOUT WEIGHTS)

AUTOMATIC DIGITAL SUPERFICIAL ROCKWELL HARDNESS TESTER CODE ISH-RSR500**

DATA OUTPUT



INSPECTION CERTIFICATE

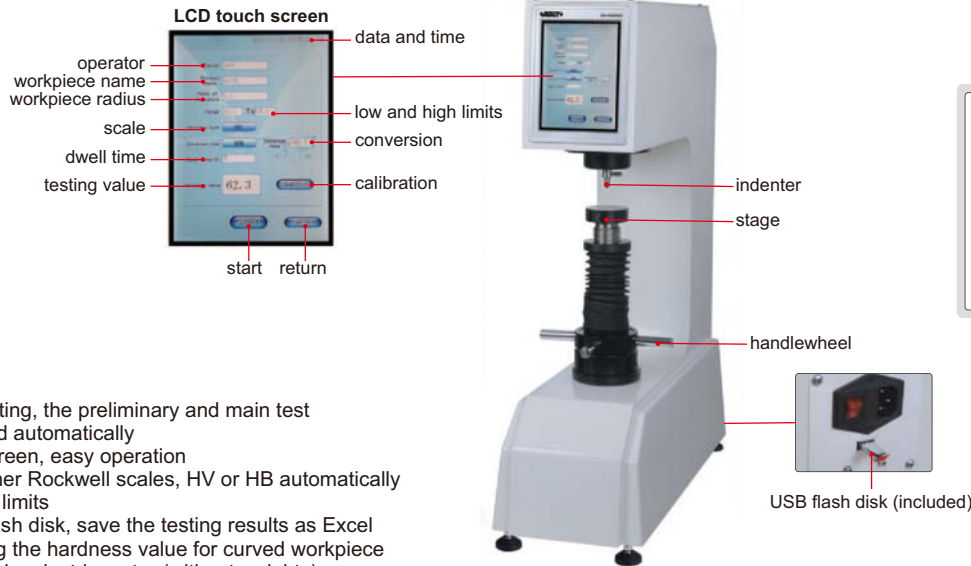

- Automatic testing, the preliminary and main test force is loaded automatically
- LCD touch screen, easy operation
- Convert to other Rockwell scales, HV or HB automatically
- Low and high limits
- Insert USB flash disk, save the testing results as Excel
- Self-correcting the hardness value for curved workpiece
- Force loading by electric motor (without weights)
- The test force is selected automatically according to hardness scale



Ø63mm flat anvil (included)



Ø150mm flat anvil (included)



level (included)



touch pen (included)



V-type anvil (included) for cylinders with diameter Ø4~60mm



small V-type anvil (optional) for cylinders with diameter Ø2~4mm

SPECIFICATION

Hardness scale	HR15N, HR30N, HR45N, HR15T, HR30T, HR45T (with standard indenters)
	HR15W, HR30W, HR45W, HR15X, HR30X, HR45X, HR15Y, HR30Y, HR45Y (with optional indenter)
Preliminary test force	29.4N/3kgf
Test force	147.1N/15kgf, 294.2N/30kgf, 441.3N/45kgf
Stage elevation	manual
Load control	automatic (load/dwell/unload)
Load dwell time	0~60 second
Resolution	0.1HR
Output	USB
Max. workpiece height	220mm
Max. workpiece depth	200mm (from the center of indenter)
Power supply	220V, 50/60Hz **
Dimension	510×260×780mm
Weight	70kg

STANDARD DELIVERY

Main unit	1pc
Ø63mm flat anvil	1pc
Ø150mm flat anvil	1pc
V-type anvil	1pc
Diamond indenter	1pc
Ø1.5875mm carbide ball indenter	1pc
Hardness test block 78~88HR15N	1pc
Hardness test block 55~73HR30N	1pc
Hardness test block 57~69HR30T	1pc
USB flash disk (8G)	1pc
Level	1pc
Touch pen	1pc
Anti-dust cover	1pc

OPTIONAL ACCESSORY

Hardness test block 78~88HR15N	ISH-BHR15N1
Hardness test block 55~73HR30N	ISH-BHR30N1
Hardness test block 57~69HR30T	ISH-BHR30T1
Small V-type anvil	ISH-SMALL ANVIL

** Add "-U" on code No. when power supply is 110V, 50/60Hz

AUTOMATIC DIGITAL ROCKWELL AND SUPERFICIAL ROCKWELL HARDNESS TESTER CODE ISH-RSR600**

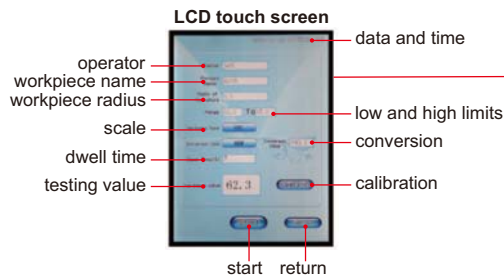

- Automatic testing, the preliminary and main test force is loaded automatically
- LCD touch screen, easy operation
- Convert to other Rockwell scales, HV or HB automatically
- Low and high limits
- Insert USB flash disk, save the testing results as Excel
- Self-correcting the hardness value for curved workpiece
- Force loading by electric motor (without weights)
- The test force is selected automatically according to hardness scale

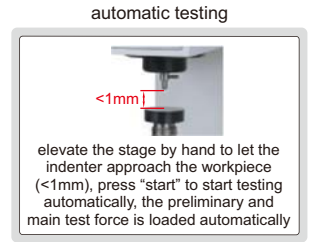

SPECIFICATION

Hardness scale	HRA, HRB, HRC, HRD, HRF, HRG, HR15N/T, HR30N/T, HR45N/T (with standard indenters)
	HRE, HRH, HRK, HRL, HRM, HRP, HRR, HRS, HRV, HR15W/X/Y, HR30W/X/Y, HR45W/X/Y (with optional indenter)
Preliminary test force	29.4N/3kgf for superficial Rockwell 98N/10kgf for Rockwell
Test force	147.1N/15kgf, 294.2N/30kgf, 441.3N/45kgf, 588N/60kgf, 980N/100kgf, 1471N/150kgf
Stage elevation	manual
Load control	automatic (load/dwell/unload)
Load dwell time	0~60 second
Resolution	0.1HR
Output	USB
Max. workpiece height	220mm
Max. workpiece depth	200mm (from the center of indenter)
Power supply	220V, 50/60Hz **
Dimension	510×260×780mm
Weight	70kg

STANDARD DELIVERY

Main unit	1pc
Ø63mm flat anvil	1pc
Ø150mm flat anvil	1pc
V-type anvil	1pc
Diamond indenter	1pc
Ø1.5875mm carbide ball indenter	1pc
Hardness test block HRB88~95	1pc
Hardness test block HRC60~65	1pc
Hardness test block HRC20~30	1pc
Hardness test block 78~88HR15N	1pc
Hardness test block 55~73HR30N	1pc
Hardness test block 57~69HR30T	1pc
USB flash disk (8G)	1pc
Level	1pc
Touch pen	1pc
Anti-dust cover	1pc

OPTIONAL ACCESSORY

Hardness test block HRB88~95	ISH-BHRB
Hardness test block HRC60~65	ISH-BHRC3
Hardness test block HRC20~30	ISH-BHRC1
Hardness test block 78~88HR15N	ISH-BHR15N1
Hardness test block 55~73HR30N	ISH-BHR30N1
Hardness test block 57~69HR30T	ISH-BHR30T1
Small V-type anvil	ISH-SMALL ANVIL

** Add "-U" on code No. when power supply is 110V, 50/60Hz



AUTOMATIC DIGITAL ROCKWELL HARDNESS TESTER CODE ISH-MRD200**

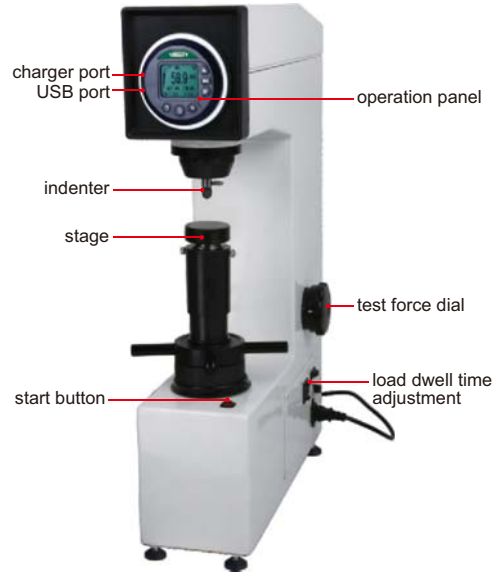
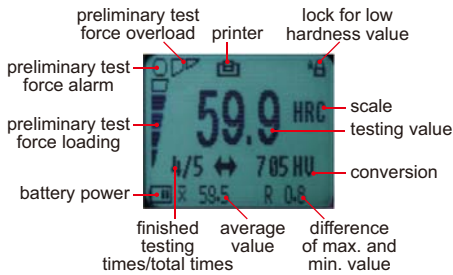

software CD (included)

- Low and high limits with alarm
- Set testing times (2~9) to have average value and the difference of max. and min. value
- Convert to HV or HB automatically
- Memory of 1000 testing values for browsing and output
- Testing value can be sent to wireless printer automatically
- Calibration function compensates the testing value for high accuracy
- The hardness value of soft materials like plastic is not stable. The lock function can obtain the value automatically
- Display unit is automatic power off



Ø60mm flat anvil (included)



Ø150mm flat anvil (included)



V-type anvil (included) for cylinders with diameter Ø4~60mm



small V-type anvil (optional) for cylinders with diameter Ø2~4mm



wireless printer (optional)

SPECIFICATION

Hardness scale	HRA, HRB, HRC, HRD HRF, HRG (with standard indenters) HRE, HRH, HRK (with optional indenter)
Preliminary test force	98N
Test force	588N, 980N, 1471N
Stage elevation	manual
Load control	automatic (load/dwell/unload)
Load dwell time	1~99 second
Resolution	0.1HR
Output	wireless and USB
Memory	1000
Max. workpiece height	170mm
Max. workpiece depth	165mm (from the center of indenter)
Power supply of the display unit	built-in rechargeable battery
Power supply	220V, 50/60Hz**
Dimension	520×160×700mm
Weight	60kg

STANDARD DELIVERY

Main unit	1pc
Ø60mm flat anvil	1pc
Ø150mm flat anvil	1pc
V-type anvil	1pc
Diamond indenter	1pc
Ø1.5875mm carbide ball indenter	1pc
Hardness test block HRB88~95	1pc
Hardness test block HRC60~65	1pc
Hardness test block HRC20~30	1pc
Anti-dust cover	1pc
USB cable and software	1pc
AC/DC adapter	1pc

OPTIONAL ACCESSORY

Wireless printer	ISH-DS-PRINTER
Ø3.175mm carbide ball indenter	ISH-EHK-INDENTER
Hardness test block HRB88~95	ISH-BHRB
Hardness test block HRC60~65	ISH-BHRC3
Hardness test block HRC20~30	ISH-BHRC1
Small V-type anvil	ISH-SMALL ANVIL

** Add "-U" on code No. when power supply is 110V, 50/60Hz



DATA OUTPUT



MANUAL DIGITAL ROCKWELL HARDNESS TESTER CODE ISH-RD200

- Low and high limits with alarm
- Set testing times (2~9) to have average value and the difference of max. and min. value
- Convert to HV or HB automatically
- Memory of 1000 testing values for browsing and output
- Testing value can be sent to wireless printer automatically
- Calibration function compensates the testing value for high accuracy
- The hardness value of soft materials like plastic is not stable. The lock function can obtain the value automatically
- Automatic power off

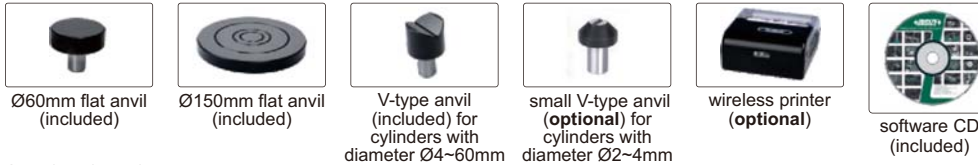
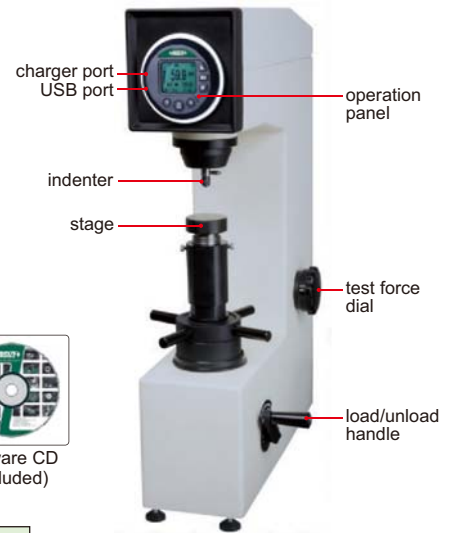
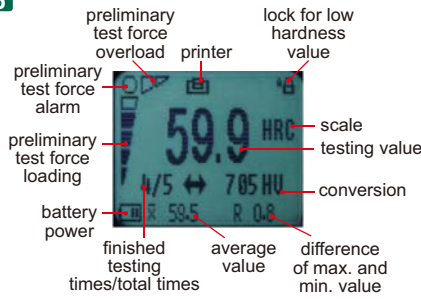

SPECIFICATION

Hardness scale	HRA, HRB, HRC, HRD HRF, HRG (with standard indenters) HRE, HRH, HRK (with optional indenter)
Preliminary test force	98N
Test force	588N, 980N, 1471N
Stage elevation	manual
Load control	manual
Resolution	0.1HR
Output	wireless and USB
Memory	1000
Max. workpiece height	170mm
Max. workpiece depth	165mm (from the center of indenter)
Power supply	built-in rechargeable battery
Dimension	520×160×700mm
Weight	60kg

STANDARD DELIVERY

Main unit	1pc
Ø60mm flat anvil	1pc
Ø150mm flat anvil	1pc
V-type anvil	1pc
Diamond indenter	1pc
Ø1.5875mm carbide ball indenter	1pc

Hardness test block HRB88~95	1pc
Hardness test block HRC60~65	1pc
Hardness test block HRC20~30	1pc
Anti-dust cover	1pc
USB cable and software	1pc
AC/DC adapter	1pc

OPTIONAL ACCESSORY

Wireless printer	ISH-DS-PRINTER
Ø3.175mm carbide ball indenter	ISH-EHK-INDENTER
Hardness test block HRB88~95	ISH-BHRB
Hardness test block HRC60~65	ISH-BHRC3
Hardness test block HRC20~30	ISH-BHRC1
Small V-type anvil	ISH-SMALL ANVIL

SPECIFICATION

Hardness scale	HRA, HRB, HRC, HRD, HRF, HRG
Preliminary test force	98N
Test force	588N, 980N, 1471N
Display	analogue
Stage elevation	manual
Load control	automatic (load/dwell/unload)
Load dwell time	1~99 second
Min. reading	0.5HR
Max. workpiece height	170mm
Max. workpiece depth	165mm (from the center of indenter)
Power supply	220V, 50/60Hz **
Dimension	520×160×700mm
Weight	60kg

STANDARD DELIVERY

Main unit	1pc
Ø60mm flat anvil	1pc
Ø150mm flat anvil	1pc
V-type anvil	1pc
Diamond indenter	1pc
Ø1.5875mm carbide ball indenter	1pc
Hardness test block HRB88~95	1pc
Hardness test block HRC60~65	1pc
Hardness test block HRC20~30	1pc
Anti-dust cover	1pc

AUTOMATIC ROCKWELL HARDNESS TESTER CODE ISH-MR150**

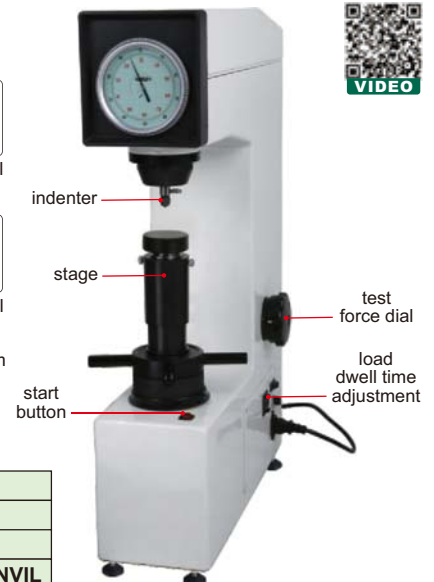
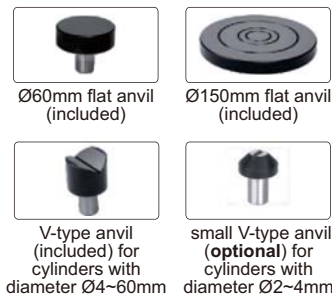

OPTIONAL ACCESSORY

Hardness test block HRB88~95	ISH-BHRB
Hardness test block HRC60~65	ISH-BHRC3
Hardness test block HRC20~30	ISH-BHRC1
Small V-type anvil	ISH-SMALL ANVIL

** Add "-U" on code No. when power supply is 110V, 50/60Hz

SPECIFICATION

Hardness scale	HRA, HRB, HRC, HRD, HRF, HRG
Preliminary test force	98N
Test force	588N, 980N, 1471N
Display	analogue
Stage elevation	manual
Load control	manual
Min. reading	0.5HR
Max. workpiece height	170mm
Max. workpiece depth	165mm (from the center of indenter)
Dimension	520×160×700mm
Weight	60kg

STANDARD DELIVERY

Main unit	1pc
Ø60mm flat anvil	1pc
Ø150mm flat anvil	1pc
V-type anvil	1pc
Diamond indenter	1pc
Ø1.5875mm carbide ball indenter	1pc
Hardness test block HRB88~95	1pc
Hardness test block HRC60~65	1pc
Hardness test block HRC20~30	1pc
Anti-dust cover	1pc

MANUAL ROCKWELL HARDNESS TESTER CODE ISH-R150

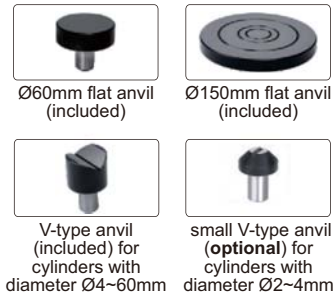

OPTIONAL ACCESSORY

Hardness test block HRB88~95	ISH-BHRB
Hardness test block HRC60~65	ISH-BHRC3
Hardness test block HRC20~30	ISH-BHRC1
Small V-type anvil	ISH-SMALL ANVIL

BRINELL/ROCKWELL/VICKERS HARDNESS TESTER CODE ISH-BRV**

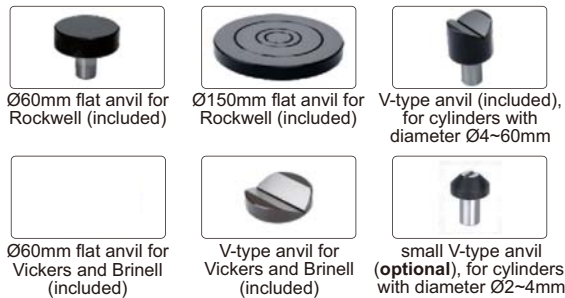

SPECIFICATION

Rockwell test load	98N preload, 588, 980, 1471N total load
Min. Rockwell reading	0.5HR
Brinell test load	306, 613, 1839N
Vickers test load	294N
Stage elevation	manual
Load control	manual
Magnification of microscope	37.5X/75X (selectable)
Max. workpiece height	180mm
Max. workpiece depth	200mm (from the center of indenter)
Power supply	220V, 50/60Hz**
Dimension	546×300×767mm
Weight	90kg

STANDARD DELIVERY

Main unit	1pc
Ø1.5875mm carbide ball indenter	1pc
Diamond Rockwell indenter	1pc
Ø5mm Brinell indenter	1pc
Ø2.5mm Brinell indenter	1pc
Vickers indenter	1pc
Ø60mm flat anvil for Rockwell	1pc
Ø150mm flat anvil for Rockwell	1pc
V-anvil for Rockwell	1pc
Ø60mm flat anvil for Vickers and Brinell	1pc
V-type anvil for Vickers and Brinell	1pc
Hardness test block HRB88~95	1pc

projection screen with scale, for reading Rockwell hardness

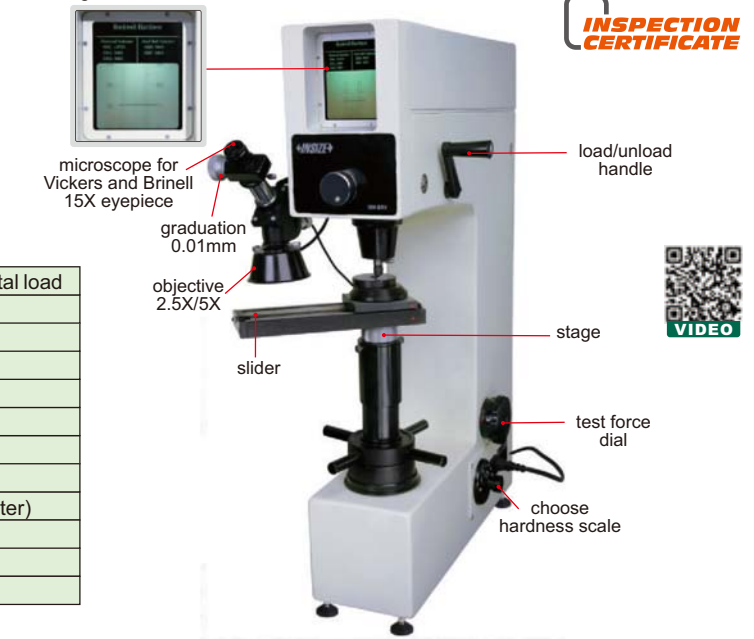

Hardness test block HRC60~65	1pc
Hardness test block HRC20~30	1pc
Hardness test block 400~500HV30	1pc
Hardness test block 180~200HBW2.5/187.5	1pc
Anti-dust cover	1pc

OPTIONAL ACCESSORY

Hardness test block HRB88~95	ISH-BHRB
Hardness test block HRC60~65	ISH-BHRC3
Hardness test block HRC20~30	ISH-BHRC1
Hardness test block 400~500HV30	ISH-BHV30
Hardness test block 180~220HBW2.5/187.5	ISH-BHB25B
Small V-type anvil	ISH-SMALL ANVIL

** Add "-U" on code No. when power supply is 110V, 50/60Hz

AUTOMATIC TESTING AFTER PRELIMINARY TEST FORCE IS LOADED BY HAND

FORCE LOADING BY ELECTRIC MOTOR (WITHOUT WEIGHTS)

INSPECTION CERTIFICATE

AUTOMATIC BRINELL HARDNESS TESTER CODE ISHB-M100**

- LCD touch screen, easy operation
- Automatic testing after preliminary test force is loaded by hand
- Measure indentation diameter by measuring microscope, input the diameters, the hardness value is shown on screen automatically
- Force loading by electric motor, without weights



test force
dwelt time
test force calibration
zero test force
hardness calculation

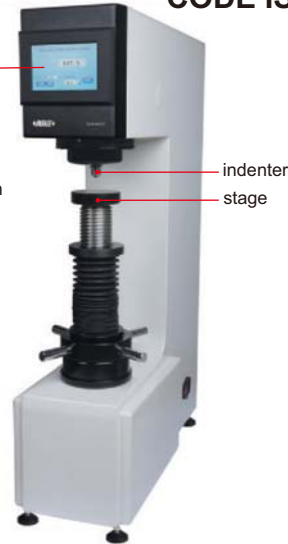

SPECIFICATION

Range	8~650HBW
Reading mode	directly read from LCD
Test force	62.5, 100, 125, 187.5, 250, 500, 750, 1000, 1500, 3000kgf
Max. height of workpiece	230mm
Max. depth of workpiece	160mm (from the center of indenter)
Stage elevation	manual
Load control	automatic (load/dwell/unload)
Load dwell time	5~60 second
Measuring microscope	magnification 20X graduation 0.01mm
Power supply	220V, 50/60Hz**
Dimension	550×210×750mm
Weight	90kg

** Add "-U" on code No. when power supply is 110V, 50/60Hz

OPTIONAL ACCESSORY

Hardness test block 150~250HBW2.5/187.5	ISH-BHB25B
Hardness test block 75~125HBW10/1000	ISH-BHB10A
Hardness test block 175~250HBW10/3000	ISH-BHB10B
Brinell indentation measuring system	ISHB-TSA/TSB

STANDARD DELIVERY

Main unit	1pc
Ø80mm flat anvil	1pc
Ø180mm flat anvil	1pc
V-type anvil	1pc
Ø2.5mm carbide ball indenter	1pc
Ø5mm carbide ball indenter	1pc

Ø10mm carbide ball indenter	1pc
Hardness test block 150~250HBW2.5/187.5	1pc
Hardness test block 75~125HBW10/1000	1pc
Hardness test block 175~250HBW10/3000	1pc
Measuring microscope	1pc
Anti-dust cover	1pc

INSPECTION CERTIFICATE

AUTOMATIC TESTING AFTER PRELIMINARY TEST FORCE IS LOADED BY HAND

AUTOMATIC DIGITAL BRINELL HARDNESS TESTERS

- Automatic testing after preliminary test force is loaded by hand
- Measure indentation by measuring microscope then read the hardness value from LCD
- Can take tests up to 40 times and display maximum, minimum and average value
- Converted to HRA, HRB, HRC, HRD, HRF, HV, HK, HR15N, HR30N, HR45N, HR15T, HR30T, HR45T
- Force loading by electric motor, without weights

SPECIFICATION

Code	ISHB-D200**	ISHB-D300**
Turret rotation	manual	automatic
Range	8~650HBW	
Reading mode	directly read from LCD	
Test force	62.5, 100, 125, 187.5, 250, 500, 750, 1000, 1500, 3000kgf	
Max. height of workpiece	200mm	
Max. depth of workpiece	135mm (from the center of indenter)	
Stage elevation	manual	
Load control	automatic (load/dwell/unload)	
Load dwell time	5~60 second	
Measuring microscope	magnification 20X	resolution 0.625mm
Power supply	220V, 50/60Hz**	
Dimension	550x210x750mm	
Weight	90kg	

OPTIONAL ACCESSORY

Hardness test block 150~250HBW2.5/187.5	ISH-BHB25B
Hardness test block 75~125HBW10/1000	ISH-BHB10A
Hardness test block 175~250HBW10/3000	ISH-BHB10B
Brinell indentation measuring system	ISHB-TSA/TSB

hardness value
diameter of indenter
dwell time
finished test times

test force
conversion
diameter of indentation

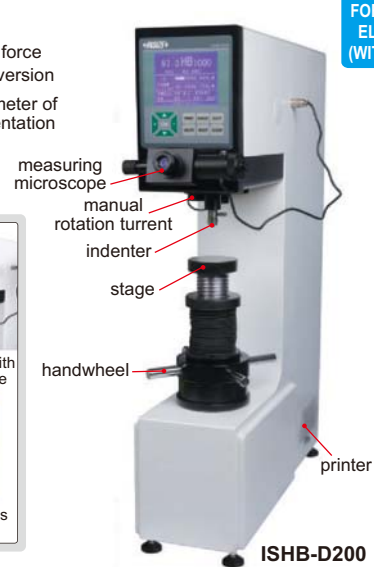

FORCE LOADING BY ELECTRIC MOTOR (WITHOUT WEIGHTS)



STANDARD DELIVERY

Main unit	1pc
Ø80mm flat anvil	1pc
Ø180mm flat anvil	1pc
V-type anvil	1pc
Ø2.5mm carbide ball indenter	1pc
Ø5mm carbide ball indenter	1pc

Ø10mm carbide ball indenter	1pc
Hardness test block 150~250HBW2.5/187.5	1pc
Hardness test block 75~125HBW10/1000	1pc
Hardness test block 175~250HBW10/3000	1pc
Anti-dust cover	1pc

** Add "-U" on code No. when power supply is 110V, 50/60Hz

BRINELL INDENTATION MEASURING SYSTEM

software (included)

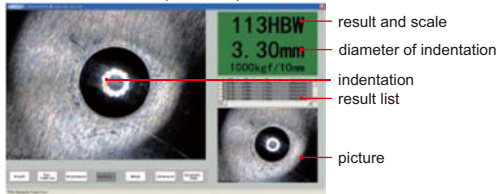

- Connected to computer USB port
- Automatically measure the indentation
- Result saved to Excel automatically
- Low and high limits with judgement
- Calibration with indentation on standard hardness block



ISHB-TSA

application



software CD (included)

STANDARD DELIVERY

Main unit	1pc
Software and dongle	1pc of each

SPECIFICATION

Code	ISHB-TSA	ISHB-TSB
Applicable Brinell indenter	Ø10mm	Ø2.5mm, Ø5mm
Hardness range	8~650HB	
Range of indentation diameter	Ø2.4~6mm	Ø0.6~3mm
Test force	100, 250, 500, 1000, 1500, 3000kgf	62.5, 125, 187.5, 250, 750kgf
Hardness resolution	1HB	
Length resolution	0.01mm	
Length accuracy	±1%(diameter of indentation)	
Camera	Sensor	1/3.2" CMOS
	Pixel	2M (resolution 1024x768)
	View filed	9×6.8mm 4.5×3.4mm
Dimension	170×54×54mm	
Weight	420g	

AUTOMATIC DIGITAL MICRO-VICKERS HARDNESS TESTER CODE ISHV-D120**

- Based on Vickers (HV), can be converted to HRA, HRB, HRC, HRD, HR15N, HR30N, HR45N, HR15T, HR30T, HR45T, HK, HBW
- Can take tests up to 99 times, display average value and the difference of max. and mini. value
- Low and high limits with judgement
- Also for Knoop hardness test, Knoop indenter is needed (optional)



slice holder (included)



vice (included)



cylinder holder (included)



level (included)

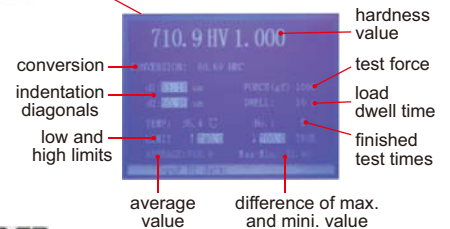

SPECIFICATION

Range	10~3000HV	
Test force	0.01, 0.025, 0.05, 0.1, 0.2, 0.3, 0.5, 1kgf	
Vickers scales	HV0.01, HV0.025, HV0.05, HV0.1, HV0.2, HV0.3, HV0.5, HV1	
Load control	automatic (load/dwell/unload)	
Load dwell time	0~60 second	
Eyepiece	magnification	10X
	resolution	0.01µm (D≥10µm), 0.001µm (D<10µm) D is diagonal length of indentation
Objective	10X, 40X	
Total magnification	100X (for observation), 400X (for measurement)	
Max. height of workpiece	210mm	
Max. depth of workpiece	135mm (from the center of indenter)	
X-Y stage	dimension: 100×100mm, travel range: 25×25mm, graduation: 0.01mm	
Power supply	220V, 50/60Hz **	
Dimension	490×320×530mm	
Weight	45kg	

STANDARD DELIVERY

Main unit	1pc
Micro Vickers indenter	1pc
Hardness test block (400~500HV0.2)	1pc
Hardness test block (700~800HV1)	1pc
Slice holder	1pc
Vice	1pc
Cylinder holder	1pc
Level	1pc
Anti-dust cover	1pc

OPTIONAL ACCESSORY

Hardness test block (400~500HV0.2)	ISH-BHV02A
Hardness test block (700~800HV1)	ISH-BHV1
Knoop indenter	ISHV-D120-KNOOP
Measuring system	9631-130
Camera adapter	ISHV-D120-ADAPTER

** Add "-U" on code No. when power supply is 110V, 50/60Hz

DIGITAL VICKERS HARDNESS TESTERS

- Based on Vickers (HV), converted to Rockwell (HRA, HRB, HRC, HRD, HRE, HRF, HRG, HRK), Brinell (HB), Superficial Rockwell (HR15N, HR15T, HR30N, HR30T, HR45N, HR45T), Shore (HS) and Strength (MPa)
- Memory of 27 measurement values for print, browsing and output
- LCD display with backlight
- Can measure Knoop hardness, Knoop indenter is needed



INSPECTION CERTIFICATE

ISH-DV10

SPECIFICATION

Code	ISH-DV10	ISH-DV50
Measuring range	8HV0.3 ~ 2500HV10	5HV1 ~ 2500HV50
Test force	0.3, 0.5, 1, 3, 5, 10kgf	1, 5, 10, 20, 30, 50kgf
Accuracy	±3%	±3% (test force 1, 5, 10, 20kgf) ±2% (test force 30, 50kgf)
Eyepiece	magnification	10X
	resolution	0.0625µm
Objective	10X, 20X	10X
Total magnification	100X (for observation) 200X (for measuring)	100X (for measuring)
Stage elevation	manual	
Load control	automatic (load/dwell/unload)	
Dwell time	5~60 second	
Max. workpiece height	160mm	
Max. workpiece depth	135mm	
Data output	RS232C	
Power supply	220V, 50/60Hz **	
Dimension	540×270×650mm	
Weight	35kg	45kg

STANDARD DELIVERY

Main unit	1pc
Ø60mm flat anvil	1pc
Ø150mm flat anvil	1pc
V-type anvil	1pc
Vickers indenter	1pc

10X objective	1pc
20X objective	1pc (for ISH-DV10)
Vickers test block	2pcs
Anti-dust cover	1pc

OPTIONAL ACCESSORY

Knoop indenter	ISH-KNOOP
Measuring system	9631-130
Hardness test block 400~500HV5	ISH-BHV5B
Hardness test block 400~500HV10	ISH-BHV10A
Hardness test block 400~500HV30	ISH-BHV30
Camera adapter	ISH-DV-ADAPTER

** Add "U" on code No. when power supply is 110V, 50/60Hz

VICKERS HARDNESS MEASURING SYSTEM CODE 9631-130

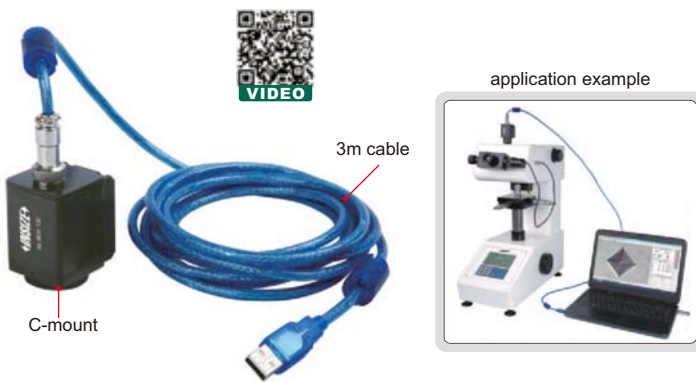

SPECIFICATION

Sensor	1/2" CMOS
Pixel	1.3M (resolution1280×1024)
Hardness measurement resolution	0.1HV
Length measurement resolution	0.1µm
Hardness measurement accuracy	±3%
Test force	0.01, 0.025, 0.05, 0.1, 0.2, 0.3, 0.5, 1, 2, 2.5, 3, 5, 10, 20, 30, 50, 100kgf
Dimension	36×33×32mm
Weight	500g

- Connected to computer USB port
- Measure the indentation size automatically or manually
- Multiple measurements to have average value, max. value and min. value
- Low and high limits with judgement
- Convert to HRA, HRB, HRC, HRD, HRE, HRF, HRG, HRK, HR15T/30T/45T, HR15N/30N/45N, HK, HV, HB, HS, HSD
- Calibration with standard test block
- Measurement result can be exported to Word or Excel

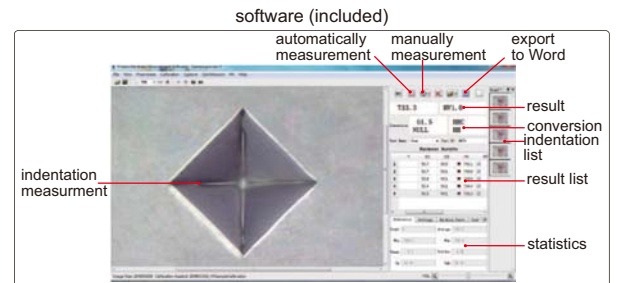

STANDARD DELIVERY

Main unit	1pc
USB dongle	1pc
USB cable and software	1pc



ULTRASONIC HARDNESS TESTER (ADVANCED MODEL) CODE ISHU-460

Application:

1. For steel, non-ferrous metal and alloy
2. Test surface hardening layers (carburized, nitriding, high frequency hardened, etc.) and plating (like chrome plating)
3. Suitable for thin wall or edge of workpieces
4. Suitable for small areas like arc, conical surface and other complex shapes
5. Suitable for small or light workpieces
6. Suitable for narrow spaces, like grooves and blind holes
7. Test large workpieces at any direction
8. Suitable for rough surfaces



test flat surfaces (with the cover)



test cylinder surfaces (use V-groove on the cover)



software CD (included)



test narrow areas (remove the cover)

- Small test indentation
- Test force and time are not affected by the operator
- Quick test, only 2 seconds
- Memory of 1000 test results
- Automatic power off
- Anti-dust and waterproof

SPECIFICATION OF MAIN UNIT

Hardness scale	HV, HB, HRB, HRC, HS, Mpa
Range	100~940HV, 80~650HB, 20~93HRB, 20~70HRC, 25~100HS, 370~1740Mpa
Resolution	1HV, 1HB, 1HRB, 0.1HRC, 1HS
Accuracy	HB ±3%
	HV ±3%
	HRC ±1.5%
Data output	USB
Operating temperature	-20°C ~ +40°C
Power supply	built-in rechargeable battery
Dimension and weight of main unit	160×80×40mm, 315g

SPECIFICATION OF PROBE

Type	A (standard)	B (optional)
Measuring force	50N	10N (small force)
Application	general use	plating
Maximum roughness of workpiece (Ra)	2.5µm	1.5µm
Minimum weight of workpiece (direct measurement)	0.1kg *	0.1kg *
Minimum thickness of workpiece (direct measurement)	1mm *	1mm *
Minimum radius of workpiece (direct measurement)	5mm	5mm
Minimum thickness of surface hardening layer or plating	0.1mm	0.03mm
Minimum measuring area	Ø1mm	Ø1mm
Dimension and weight of probe	140×Ø37mm, 271g	145×Ø37mm, 271g

STANDARD DELIVERY

Main unit	1pc
Probe A	1pc
AC/DC adapter	1pc
USB cable and software	1pc

OPTIONAL ACCESSORY

Probe B	ISHU-460-B
Couplant	ISH-COULPLANT

* If the weight or thickness of workpiece is less than required, the workpiece should be fixed or coupled on solid support.

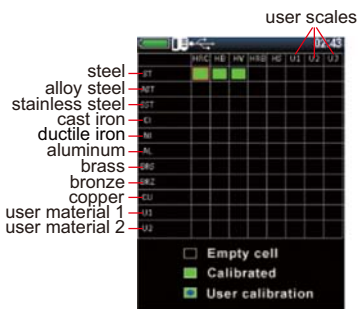

select the material and scale, use the corresponding standard hardness blocks or workpieces for calibration (calibration of HRC, HB and HV for steel are already made, calibration is needed before use other materials and scales)



can take a picture on the workpiece and get a report with testing result and picture, the report can be sent to computer



back

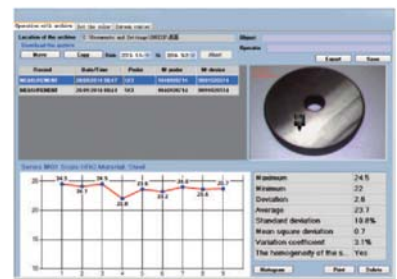

software (included), output data, make and print reports, screen capture, set screen colors of hardness tester



Graph display mode, show average value, relative range and test times

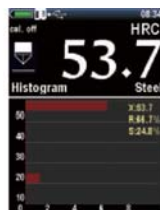

Histogram display mode, show average value, relative range and relative standard deviation



Statistics display mode, show maximum, minimum, deviation, average, relative range and test times



Smart display mode, can set tolerance, automatically reject the result when out of tolerance

ULTRASONIC/LEEB HARDNESS TESTER (ADVANCED MODEL) CODE ISHU-470



DATA OUTPUT

INSPECTION CERTIFICATE



Application and features:

1. For steel, non-ferrous metal and alloy
2. Test surface hardening layers (carburized, nitriding, high frequency hardened, etc.) and plating (like chrome plating)
3. Suitable for thin wall or edge of workpieces
4. Suitable for small areas like arc, conical surface and other complex shapes
5. Suitable for small or light workpieces
6. Suitable for narrow spaces, like grooves and blind holes
7. Test large workpieces at any direction
8. Suitable for rough surfaces
9. Small test indentation
10. Test force and time are not affected by the operator
11. Quick test, only 2 seconds



main unit (included)



ultrasonic probe A (included)



Leeb probe type D (included)



Application and features:

1. Suitable for large and heavy workpieces, such as casting parts, molds, machine guides, etc.
2. For steel, non-ferrous metal and alloy
3. Based on Leeb (HLD), converted to Rockwell (HRC), Vickers (HV), Brinell (HB) and strength (Mpa)
4. Impact direction is adjustable
5. According to ASTM A956

- Automatic detect the ultrasonic probe or Leeb probe type D
- Memory of 1000 test results for browsing and output
- Automatic power off
- Anti-dust and waterproof

APPLICATION OF ULTRASONIC HARDNESS TESTER AND LEEB HARDNESS TESTER

Application	Ultrasonic	Leeb
Solid parts, molds, etc.	well suited	especially suited
Coarse grain materials, cast iron parts, etc.	not recommended	especially suited
Steel and aluminum cast alloys	suited sometimes	especially suited
HAZ with welds	especially suited	not recommended
Tubes: wall thickness > 10 mm	especially suited	especially suited
Tubes: wall thickness < 10 mm	especially suited	not recommended
Rough surfaces	not recommended	well suited
Thin workpieces	especially suited	not recommended
Difficult to access positions, like turbine blades, gears, etc.	especially suited	well suited



software CD (included) ultrasonic probe to test flat surfaces (with the cover) ultrasonic probe to test cylinder surfaces (use V-groove on the cover) ultrasonic probe to test narrow areas (remove the cover)



Graph display mode, show average value, relative range and test times



Histogram display mode, show average value, relative range and relative standard deviation

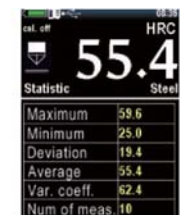

Statistics display mode, show maximum, minimum, deviation, average, relative range and test times

SPECIFICATION OF MAIN UNIT

Hardness scale	HV, HB, HRB, HRC, HS, HL, Mpa	
Range	100~940HV, 80~650HB, 20~93HRB, 20~70HRC, 25~100HS, 170~960HL, 370~1740Mpa	
Resolution	1HV, 1HB, 1HRB, 0.1HRC, 1HS, 1HL, 1Mpa	
Accuracy of ultrasonic test	HB	±3%
	HV	±3%
	HRC	±1.5%
Accuracy of Leeb test	HL	±6HL
Data output	USB	
Operating temperature	-20°C ~ +40°C	
Power supply	built-in rechargeable battery	
Dimension of main unit	160×80×40mm	
Weight of main unit	315g	



Smart display mode, can set tolerance, automatically reject the result when out of tolerance

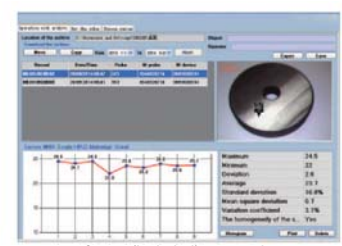

software (included), output data, make and print reports, screen capture, set screen colors of hardness tester

SPECIFICATION OF PROBE

Type	ultrasonic A (standard)	ultrasonic B (optional)	Leeb type D (standard)
Test force	50N	10N (small force)	-
Application	general use	plating	large and heavy workpieces
Maximum roughness of workpiece (Ra)	2.5µm	1.5µm	1.6µm
Minimum weight of workpiece (direct measurement)	0.1kg*	0.1kg*	5kg*
Minimum thickness of workpiece (direct measurement)	1mm*	1mm*	5mm*
Minimum radius of workpiece	5mm	5mm	30mm
Minimum thickness of surface hardening layer or plating	0.1mm	0.03mm	-
Minimum test area	Ø1mm	Ø1mm	Ø20mm
Dimension and weight of probe	140×Ø37mm, 271g	145×Ø37mm, 271g	148×Ø20mm, 100g

* If the weight or thickness of workpiece is less than required, the workpiece should be fixed or coupled on solid support.

To be continued

Continued from previous page



take a picture on the workpiece and get a report with testing result and picture, the report can be sent to computer

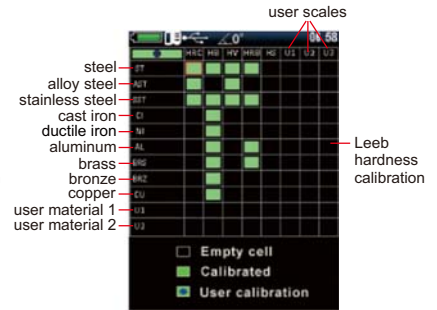
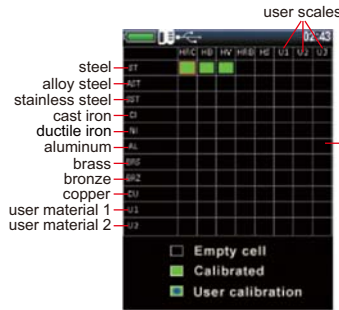

select the material and scale, use the corresponding standard hardness blocks or workpieces for calibration ("■" means the calibration is already made, calibration is needed before using other materials and scales)

STANDARD DELIVERY

Main unit	1pc
Ultrasonic probe A	1pc
Leeb probe type D	1pc
Hardness test block D	1pc
AC/DC adapter	1pc
USB cable and software	1pc

OPTIONAL ACCESSORY

Ultrasonic probe B	ISHU-460-B
Leeb support rings	see details
Couplant	ISH-COULPLANT

Application:

1. For steel, non-ferrous metal and alloy
2. Test surface hardening layers (carburized, nitriding, high frequency hardened, etc.) and plating (like chrome plating)
3. Suitable for thin wall or edge of workpieces
4. Suitable for small areas like arc, conical surface and other complex shapes
5. Suitable for small or light workpieces
6. Suitable for narrow spaces, like grooves and blind holes
7. Test large workpieces at any direction
8. Suitable for rough surfaces

- Small test indentation
- Test force and time are not affected by the operator
- Quick test, only 2 seconds
- Average and statistics test modes
- Memory of 1024 test results for browsing and output
- Automatic power off
- Anti-dust and waterproof

SPECIFICATION OF MAIN UNIT

Hardness scale	HV, HB, HRC, Mpa
Range	100~940HV, 80~650HB, 20~70HRC, 370~1740Mpa
Resolution	1HV, 1HB, 0.1HRC, 1Mpa
Accuracy	HB ±3%
	HV ±3%
	HRC ±1.5%
Data output	USB
Operating temperature	-20°C ~ +40°C
Power supply	built-in rechargeable battery
Dimension of main unit	120×60×25mm
Weight of main unit	200g

SPECIFICATION OF PROBE

Type	A (standard)	B (optional)
Test force	50N	10N (small force)
Application	general use	plating
Maximum roughness of workpiece (Ra)	2.5µm	1.5µm
Minimum weight of workpiece (direct measurement)	0.1kg *	0.1kg *
Minimum thickness of workpiece (direct measurement)	1mm *	1mm *
Minimum radius of workpiece	5mm	5mm
Minimum thickness of surface hardening layer or plating	0.1mm	0.03mm
Minimum test area	Ø1mm	Ø1mm
Dimension and weight of probe	140×Ø37mm, 271g	145×Ø37mm, 271g

* If the weight or thickness of workpiece is less than required, the workpiece should be fixed or coupled on solid support.



**ULTRASONIC HARDNESS TESTER
CODE ISHU-330**



software CD (included)



test flat surfaces (with the cover)



test cylinder surfaces (use V-groove on the cover)



test narrow areas (remove the cover)

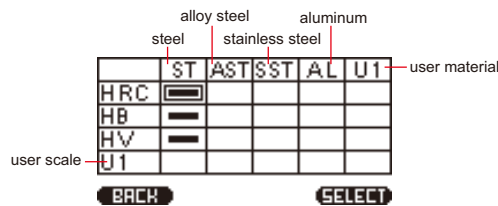

select the material and scale, use the corresponding standard hardness blocks or workpieces for calibration (calibration of HRC, HB and HV for steel are already made, calibration is needed before use other materials and scales)

STANDARD DELIVERY

Main unit	1pc
Probe A	1pc
Rechargeable battery	2pcs
Charger	1pc
USB cable and software	1pc

OPTIONAL ACCESSORY

Probe B	ISHU-460-B
Couplant	ISH-COULPLANT

ULTRASONIC/LEEB HARDNESS TESTER CODE ISHU-340

- Automatic detect the ultrasonic probe or Leeb probe type D
- Average and statistics test modes
- Memory of 1024 test results for browsing and output
- Automatic power off
- Anti-dust and waterproof

**INSPECTION
CERTIFICATE**



**DATA
OUTPUT**



**main unit
(included)**



**ultrasonic probe A
(included)**



**Leeb probe type D
(included)**



Application and features:

1. For steel, non-ferrous metal and alloy
2. Test surface hardening layers (carburized, nitriding, high frequency hardened, etc.) and plating (like chrome plating)
3. Suitable for thin wall or edge of workpieces
4. Suitable for small areas like arc, conical surface and other complex shapes
5. Suitable for small or light workpieces
6. Suitable for narrow spaces, like grooves and blind holes
7. Test large workpieces at any direction
8. Suitable for rough surfaces
9. Small test indentation
10. Test force and time are not affected by the operator
11. Quick test, only 2 seconds



Application and features:

1. Suitable for large and heavy workpieces, such as casting parts, molds, machine guides, etc.
2. For steel, non-ferrous metal and alloy
3. Based on Leeb (HLD), converted to Rockwell (HRC), Vickers (HV), Brinell (HB) and strength (Mpa)
4. Impact direction is adjustable
5. According to ASTM A956



**software CD
(included)**



**ultrasonic probe to test flat surfaces
(with the cover)**



ultrasonic probe to test cylinder surfaces (use V-groove on the cover)



**ultrasonic probe to test narrow areas
(remove the cover)**

APPLICATION OF ULTRASONIC HARDNESS TESTER AND LEEB HARDNESS TESTER

Application	Ultrasonic	Leeb
Solid parts, molds, etc.	well suited	especially suited
Coarse grain materials, cast iron parts, etc.	not recommended	especially suited
Steel and aluminum cast alloys	suited sometimes	especially suited
HAZ with welds	especially suited	not recommended
Tubes: wall thickness > 10 mm	especially suited	especially suited
Tubes: wall thickness < 10 mm	especially suited	not recommended
Rough surfaces	not recommended	well suited
Thin workpieces	especially suited	not recommended
Difficult to access positions, like turbine blades, gears, etc.	especially suited	well suited

SPECIFICATION OF MAIN UNIT

Hardness scale	HV, HB, HRC, HL, Mpa	
Range	100~940HV, 80~650HB, 20~70HRC, 170~960HL, 370~1740Mpa	
Resolution	1HV, 1HB, 0.1HRC, 1HL, 1Mpa	
Accuracy of ultrasonic test	HB	±3%
	HV	±3%
	HRC	±1.5%
Accuracy of Leeb test	HL	±6HL
Data output	USB	
Operating temperature	-20°C ~ +40°C	
Power supply	built-in rechargeable battery	
Dimension of main unit	120×60×25mm	
Weight of main unit	200g	

STANDARD DELIVERY

Main unit	1pc
Ultrasonic probe A	1pc
Leeb probe type D	1pc
Hardness test block D	1pc
Rechargeable battery	2pcs
Charger	1pc
USB cable and software	1pc

OPTIONAL ACCESSORY

Ultrasonic probe B	ISHU-460-B
Leeb support rings	see details
Couplant	ISH-COULPLANT

	alloy steel	aluminum	
	steel	stainless steel	
ST	■	■	user material
AST	■	■	ultrasonic hardness calibration
SST	■	■	
AL	■	■	
U1	■	■	
U2	■	■	

user scale

	alloy steel	aluminum	
	steel	stainless steel	
ST	■	■	user material
AST	■	■	Leeb hardness calibration
SST	■	■	
AL	■	■	
U1	■	■	
U2	■	■	

user scale

select the material and scale, use the corresponding standard hardness blocks or workpieces for calibration ("■" means the calibration is already made, calibration is needed before using other materials and scales)



software (included), output data, make and print reports

SPECIFICATION OF PROBE

Type	ultrasonic A (standard)	ultrasonic B (optional)	Leeb type D (standard)
Test force	50N	10N (small force)	-
Application	general use	plating	large and heavy workpieces
Maximum roughness of workpiece (Ra)	2.5µm	1.5µm	1.6µm
Minimum weight of workpiece (direct measurement)	0.1kg*	0.1kg*	5kg*
Minimum thickness of workpiece (direct measurement)	1mm*	1mm*	5mm*
Minimum radius of workpiece	5mm	5mm	30mm
Minimum thickness of surface hardening layer or plating	0.1mm	0.03mm	-
Minimum test area	Ø1mm	Ø1mm	Ø20mm
Dimension and weight of probe	140×Ø37mm, 271g	145×Ø37mm, 271g	148×Ø20mm, 100g

* If the weight or thickness of workpiece is less than required, the workpiece should be fixed or coupled on solid support.



DATA
OUTPUT



PORTABLE LEEB HARDNESS TESTER CODE ISH-SPHA

- Based on Leeb (HL), converted to Vickers (HV), Brinell (HB), Rockwell (HRC and HRB), Shore (HS) and tensile strength (MPa)
- Connected with printer via bluetooth
- Connected with computer via USB port
- Up to 800 test results can be saved
- Low and high limits with judgement
- Touch screen operation, large display with backlight
- Language: English, Chinese, Italian, German, French and Portuguese
- Automatic power off
- According to ASTM A 956



software CD
(included)



hardness test
block D (included)



small support ring
(included)



printer
(included)

SPECIFICATION

Min. reading	1HL, 1HV, 1HB, 0.1HRC, 0.1HRB, 1HS, 1MPa
Accuracy	±6HL (when HL=800)
Display	Leeb (HL), converted hardness, material, impact direction, test times, average value, deviation, time
Output	bluetooth and USB
Power supply	built-in rechargeable battery
Dimension	135×83×24mm
Weight	350g

STANDARD DELIVERY

Main unit	1pc
Impact device D	1pc
Printer	1pc
Hardness test block D	1pc
Small support ring	1pc
Cleaning brush	1pc
AC/DC adapter	1pc
USB cable and software disc	1pc
Pen for touch screen	1pc

OPTIONAL ACCESSORY

Impact device DC	ISH-SPHA-DC
Impact device C	ISH-SPHA-C
Impact device D+15	ISH-SPHA-D15
Impact device DL	ISH-SPHA-DL
Impact device G	ISH-SPHA-G
Hardness test block D*	ISH-BHLD
Hardness test block G*	ISH-BHLG
Couplant	ISH-COUPPLANT
Support rings	see details

* Hardness test block G (ISH-BHLG) is for impact device G (ISH-SPHA-G).
Hardness test block D (ISH-BHLD) is for all others impact devices.

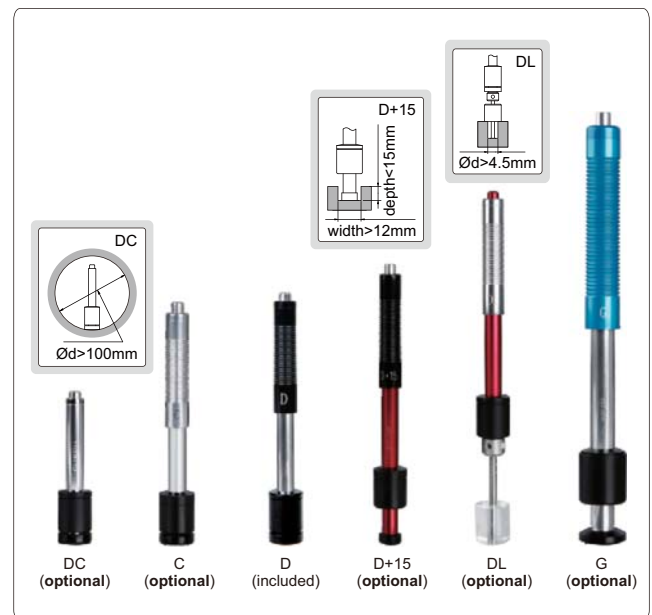

APPLICABLE WORKPIECE

Impact device	DC	C	D	D+15	DL	G
Application	inner wall of small space	small or thin workpiece, coating layer	general use	deep groove	narrow slot or small hole	casting or forging workpiece
Maximum roughness of workpiece (Ra)	1.6µm	0.4µm	1.6µm	1.6µm	1.6µm	7µm
Minimum weight of workpiece	direct measurement	5kg	1.5kg	5kg	5kg	15kg
	on solid support	2kg	0.5kg	2kg	2kg	5kg
	coupled on plate	0.1kg	0.02kg	0.1kg	0.1kg	0.5kg
Minimum thickness of workpiece	5mm	1mm	5mm	5mm	5mm	10mm

PORTABLE LEEB HARDNESS TESTER (BASIC MODEL) CODE ISHL-P100



hardness test block D (included)



small support ring (included)



- Supplied with impact device D
- Based on Leeb (HLD), converted to Vickers (HV), Brinell (HB), Rockwell (HRC and HRB), Shore (HS) and tensile strength (MPa)
- Set test times (1~32) to have average value
- Memory of 100 test values for browsing
- Automatic power off

SPECIFICATION

Min. reading	1HLD, 1HV, 1HB, 0.1HRC, 0.1HRB, 1HS, 1MPa	
Accuracy	±8HLD (when HLD=760±30)	
Display	Leeb, conversion hardness, material, impact direction, test times, average value, time	
Applicable workpiece	minimum weight	5kg 2kg (on solid support) 0.1kg (coupled on plate)
	minimum thickness:	5mm
	minimum radius of curved surface:	30mm
	maximum roughness (Ra):	1.6µm
Power supply	3×AAA batteries	
Dimension	155×72×27mm	
Weight	280g	

STANDARD DELIVERY

Main unit	1pc
Impact device D	1pc
Hardness test block D	1pc
Small support ring	1pc
Cleaning brush	1pc

OPTIONAL ACCESSORY

Couplant	ISH-COUPPLANT
Hardness test block D	ISHL-P100-BLOCK
Support rings	see details

APPLICABLE MATERIAL AND HARDNESS RANGE FOR IMPACT DEVICE D

Material	HLD	HV	HB	HRC	HRB	HS	Tensile strength (MPa)
Steel & cast steel	300-900	81-955	81-654	20-68	38-100	32-100	375-2639
Tool steel	300-840	80-898		20-67			
Stainless steel	300-800	85-802	85-655		46-101		
Cast iron	360-650		93-334				
Cast aluminum alloy	170-570		19-164		23-84		
Brass	200-550		40-173		13-95		
Bronze	300-700		60-290				
Copper	200-690		45-315				

PORTABLE LEEB HARDNESS TESTER (BASIC MODEL) CODE ISHL-P200



software CD (included)



hardness test block D (included)



small support ring (included)



DATA OUTPUT

WITH BUILT-IN PRINTER

- Supplied with impact device D and built-in printer
- Based on Leeb (HLD), converted to Vickers (HV), Brinell (HB), Rockwell (HRC and HRB), Shore (HS) and tensile strength (MPa)
- Set test times (1~32) to have average value
- Memory of 100 test values for browsing, print and output
- Low and high limits with judgement
- Automatic power off

SPECIFICATION

Min. reading	1HLD, 1HV, 1HB, 0.1HRC, 0.1HRB, 1HS, 1MPa	
Accuracy	±8HLD (when HLD=760±30)	
Display	Leeb, conversion hardness, material, impact direction, test times, average value, time	
Applicable workpiece	minimum weight	5kg 2kg (on solid support) 0.1kg (coupled on plate)
	minimum thickness:	5mm
	minimum radius of curved surface:	30mm
	maximum roughness (Ra):	1.6µm
Power supply	built-in rechargeable battery	
Dimension	198×82×30mm	
Weight	320g	

STANDARD DELIVERY

Main unit with printer	1pc
Impact device D	1pc
Hardness test block D	1pc
Printer paper	1pc
Small support ring	1pc
Cleaning brush	1pc
USB cable and software	1pc
AC/DC adapter	1pc

OPTIONAL ACCESSORY

Couplant	ISH-COUPPLANT
Hardness test block D	ISHL-P100-BLOCK
Printer paper	ISHL-P200-PAPER
Support rings	see details

APPLICABLE MATERIAL AND HARDNESS RANGE FOR IMPACT DEVICE D

Material	HLD	HV	HB	HRC	HRB	HS	Tensile strength (MPa)
Steel & cast steel	300-900	81-955	81-654	20-68	38-100	32-100	375-2639
Tool steel	300-840	80-898		20-67			
Stainless steel	300-800	85-802	85-655		46-101		
Cast iron	360-650		93-334				
Cast aluminum alloy	170-570		19-164		23-84		
Brass	200-550		40-173		13-95		
Bronze	300-700		60-290				
Copper	200-690		45-315				

PORTABLE LEEB HARDNESS TESTER CODE ISH-PHB

SPECIFICATION

Min. reading	1HLD, 1HV, 1HB, 0.1HRC, 0.1HRB, 1HS, 1MPa	
Accuracy	±6HLD (when HLD=800)	
Display	Leeb (HLD), converted hardness, material, impact direction, test times, average value, date	
Output	bluetooth	
Applicable workpiece	minimum weight	5kg
		2kg (on solid support)
		0.1kg (coupled on plate)
	minimum thickness: 5mm	
	minimum radius of curved surface: 30mm	
	maximum roughness (Ra): 1.6µm	
Power supply	3×AAA batteries	
Dimension	150×84×28mm	
Weight	200g	



- Based on Leeb (HLD), converted to Vickers (HV), Brinell (HB), Rockwell (HRC and HRB), Shore (HS) and tensile strength (MPa)
- Memory of 99 measurement values for browsing
- Set measurement times (1~9) to have average value
- Connected with printer via bluetooth
- Automatic power off
- According to ASTM A 956

STANDARD DELIVERY

Main unit	1pc
Impact device D	1pc
Hardness test block D	1pc
Small support ring	1pc
Cleaning brush	1pc

APPLICABLE MATERIAL AND HARDNESS RANGE FOR IMPACT DEVICE D

Material	HLD	HV	HB	HRC	HRB	HS	Tensile strength (MPa)
Steel & cast steel	300-900	81-955	81-654	20-68	38-100	32-100	375-2639
Tool steel	300-840	80-898		20-67			
Stainless steel	300-800	85-802	85-655		46-101		
Cast iron	360-650		93-334				
Cast aluminum alloy	170-570		19-164		23-84		
Brass	200-550		40-173		13-95		
Bronze	300-700		60-290				
Copper	200-690		45-315				

OPTIONAL ACCESSORY

Wireless printer	ISH-DS-PRINTER
Couplant	ISH-COUPPLANT
Support rings	see details
Hardness test block D	ISH-BHLD

- Impact device D
- Based on Leeb (HLD), converted to Vickers (HV), Brinell (HB), Rockwell (HRC and HRB), Shore (HS) and tensile strength (MPa)
- Automatic direction correction
- Connected with printer via bluetooth
- Connected with computer via USB port
- Up to 500 test results can be saved
- According to ASTM A 956



software CD (included)



printer (included)



hardness test block D (included)



small support ring (included)

SPECIFICATION

Min. reading	1HLD, 1HV, 1HB, 0.1HRC, 0.1HRB, 1HS	
Accuracy	±6HLD (when HLD=800)	
Output	USB and bluetooth	
Applicable workpiece	minimum weight	5kg (direct measurement)
		2kg (on solid support)
		0.1kg (coupled on plate)
	minimum thickness: 5mm	
	minimum radius of curved surface: 30mm	
	maximum roughness (Ra): 1.6µm	
Power supply	built-in rechargeable battery	
Dimension	147×35×22mm	
Weight	65g	

APPLICABLE MATERIAL AND HARDNESS RANGE FOR IMPACT DEVICE D

Material	HLD	HV	HB	HRC	HRB	HS
Steel & cast steel	300-900	81-955	81-654	20-68	38-100	32-100
Tool steel	300-840	80-898		20-67		
Stainless steel	300-800	85-802	85-655		46-101	
Cast iron	360-650		93-334			
Cast aluminum alloy	170-570		19-164		23-84	
Brass	200-550		40-173		13-95	
Bronze	300-700		60-290			
Copper	200-690		45-315			

PORTABLE LEEB HARDNESS TESTER CODE ISH-SPHD

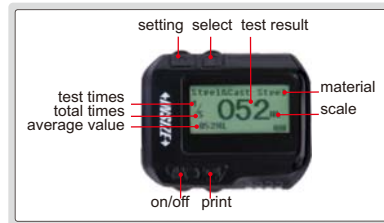

STANDARD DELIVERY

Main unit	1pc
Printer	1pc
Hardness test block D	1pc
Small support ring	1pc
Cleaning brush	1pc
AC/DC adapter	1pc
USB cable and software disc	1pc

OPTIONAL ACCESSORY

Couplant	ISH-COUPPLANT
Support rings	see details
Hardness test block D	ISH-BHLD

SUPPORT RING SET FOR PORTABLE LEEB HARDNESS TESTER CODE ISH-PH-SP9



VIDEO

type A

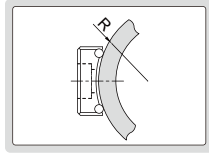

type B

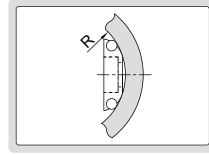

type C

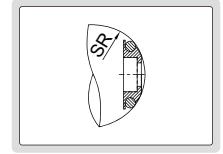

SPECIFICATION

Type	Applicable workpiece	Range (mm)	Quantity
A	cylindrical outside surface	R10-15	3pcs
		R14.5-30	
		R25-50	
B	cylindrical inside surface	R11-13	3pcs
		R12.5-17	
		R16.5-30	
C	spherical inside surface	SR11-13	3pcs
		SR12.5-17	
		SR16.5-30	
D	spherical outside surface	SR10-15	2pcs
		SR14.5-30	
E	cylindrical outside surface	R > 10	1pcs

type D



type E

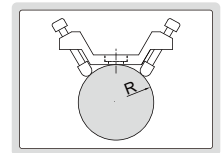
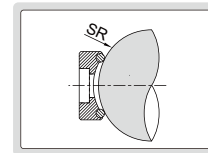

DIGITAL MAGNETIC ROCKWELL HARDNESS TESTER CODE ISHR-D121



VIDEO



flat anvil for test block
(included)

- Apply to large and heavy steel or iron workpieces
- With statistic function, display average, maximum and minimum values
- Convert to HV, HB and tensile strength
- According to ISO 6508, ASTM E18

SPECIFICATION

Hardness scale	HRA, HRB, HRC
Preliminary test force	10kg
Test force	60kg, 100kg, 150kg
Load control	manual
Min. reading	0.1HR
Flat workpiece requirement	length>190mm, width>60mm, thickness>5mm
Cylinder or tube workpiece requirement	length>200mm, diameter>Ø50mm, wall thickness>8mm
Power supply	3×AAA batteries
Dimension	245×105×230mm
Weight	5.3kg

STANDARD DELIVERY

Main unit	1pc
Flat anvil	1pc
Diamond indenter	1pc
Ø1.5875mm carbide ball indenter	1pc
Hardness test block HRB85~95	1pc
Hardness test block HRC60~70	1pc
Hardness test block HRC20~30	1pc

MAGNETIC ROCKWELL HARDNESS TESTER CODE ISHR-M111

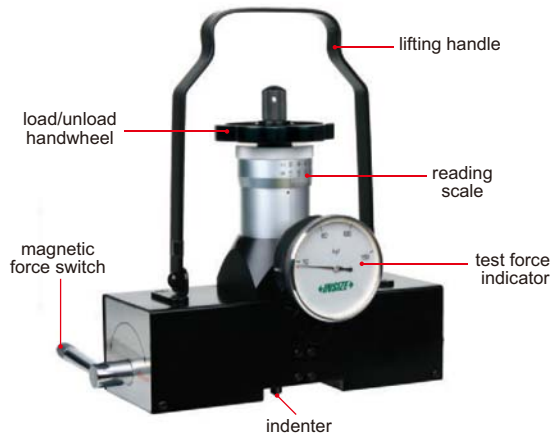

- Apply to large and heavy steel or iron workpieces
- According to ISO 6508, ASTM E18



flat anvil for test block
(included)



supports for cylinder or
tube workpieces (included)



magnifier with LED
(included)

SPECIFICATION

Hardness scale	HRA, HRB, HRC, HRD, HRF, HRG
Preliminary test force	10kg
Test force	60kg, 100kg, 150kg
Load control	manual
Min. reading	1HR
Flat workpiece requirement	length>180mm, width>60mm, thickness>5mm
Cylinder or tube workpiece requirement	length>180mm, diameter>Ø50mm, wall thickness>8mm
Dimension	220×70×220mm
Weight	4.7kg

STANDARD DELIVERY

Main unit	1pc
Diamond indenter	1pc
Ø1.5875mm carbide ball indenter	2pcs
Hardness test block HRB85~95	1pc
Hardness test block HRC60~70	1pc
Hardness test block HRC20~30	1pc
Flat anvil	1pc
Support	4pcs
Magnifier with LED	1pc

MAGNETIC BRINELL/ROCKWELL HARDNESS TESTER CODE ISHR-B141



flat anvil for test block
(included)



supports for cylinder or
tube workpieces (included)



magnifier with LED
(included)



measuring microscope
(included)

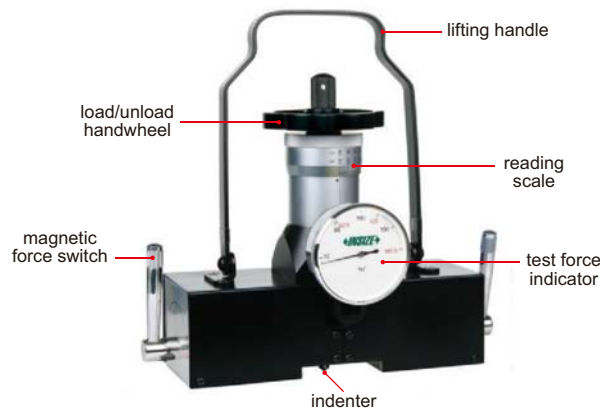

- Apply to large steel or iron workpieces
- According to ISO 6508, ASTM E18

SPECIFICATION

Rockwell scale	HRA, HRB, HRC, HRD, HRF, HRG
Brinell measuring range	20~650HBW
Rockwell test force	10kg preload, 60kg, 100kg, 150kg total load
Brinell test force	62.5kg, 125kg, 187.5kg
Load control	manual
Min. Rockwell reading	1HR
Measuring microscope	40X, graduation 0.01mm
Flat workpiece requirement	length>180mm, width>60mm, thickness>5mm
Cylinder and tube workpiece requirement	length>180mm, diameter>Ø50mm, thickness>8mm
Dimension	220×70×220mm
Weight	4.7kg

STANDARD DELIVERY

Main unit	1pc
Flat anvil	1pc
Support	4pcs
Diamond Rockwell indenter	1pc
Ø1.5875mm carbide ball indenter	1pc
Ø2.5mm Brinell indenter	1pc
Hardness test block HRB85~95	1pc
Hardness test block HRC60~70	1pc
Hardness test block HRC20~30	1pc
Brinell test block	1pc
Measuring microscope	1pc
Magnifier with LED	1pc

PORTABLE ROCKWELL HARDNESS TESTER CODE ISHR-P151

- According to ISO 6508, ASTM E18

SPECIFICATION

Hardness scale	HRA, HRB, HRC, HRD, HRF, HRG
Preliminary test force	10kg
Test force	60kg, 100kg, 150kg
Load control	manual
Min. reading	1HR
Max. workpiece thickness	25mm
Max. workpiece depth	25mm
Dimension	240×70×160mm
Weight (with base)	2.5kg

STANDARD DELIVERY

Main unit	1pc
Diamond indenter	1pc
Ø1.5875mm carbide ball indenter	2pcs
Hardness test block HRB88~95	1pc
Hardness test block HRC60~65	1pc
Hardness test block HRC20~30	1pc
Flat anvil	1pc
V-type anvil	1pc
Base	1pc
Anvil extension	1pc
Magnifier	2pcs

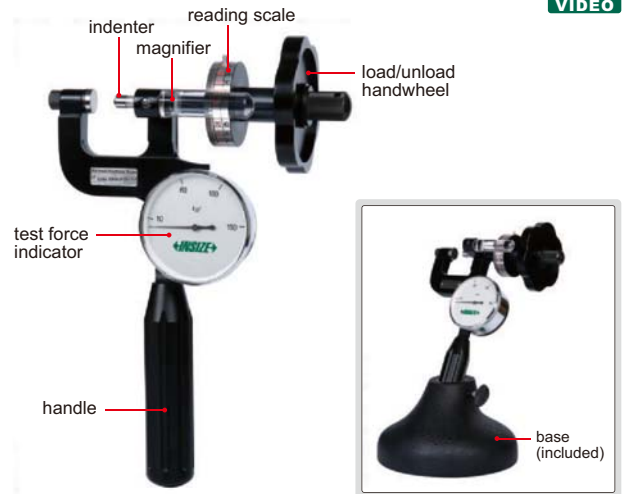

flat anvil (included)



V-type anvil (included)



anvil extension for thin workpieces (included)



VIDEO

PIN BRINELL HARDNESS TESTER CODE ISHB-P101

- Measure Brinell hardness of large and heavy workpieces
- 1580kg test force and Ø7.26mm ball indenter, equal to 3000kg test force and Ø10mm ball indenter
- Static and impact test modes
- According to ISO and ASTM standard



static test clamp



impact test clamp

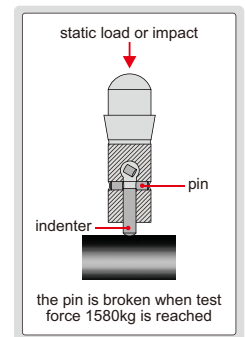

static test



impact test



V-type anvil (included)



pins (included)



measuring microscope (included)

SPECIFICATION

Measuring range	100~350HBW (with Ø7.26mm indenter, included) 350~650HBW (with Ø4mm indenter, optional)
Test force	1580kg
Accuracy	static test: ±3% impact test: ±5%
Measuring microscope	20X, graduation 0.01mm
Max. workpiece height in static test	150mm
Max. workpiece depth in static test	80mm (from the center of indenter)
Dimension	195×60×350mm
Weight	4.2kg

STANDARD DELIVERY

Static test clamp	1pc
Impact test clamp	1pc
Flat anvil	1pc
V-type anvil	1pc
Ø7.26mm indenter	1pc
Hardness test block	1pc
Pin	250pcs
Measuring microscope	1pc

OPTIONAL ACCESSORY

Ø4mm indenter	ISHB-P101-INDENTER
Pin (250pcs)	ISHB-P101-PIN



VIDEO

HYDRAULIC BRINELL HARDNESS TESTER CODE ISHB-H131

- According to ISO 6506, ASTM E10

SPECIFICATION

Measuring range	16~650HBW
Test force	3000kg
Indenter	Ø10mm carbide ball
Measuring microscope	20X, graduation 0.01mm
Max. workpiece height	350mm
Max. workpiece depth	90mm (from the center of indenter)
Dimension	270×225×570mm
Weight	13.8kg

STANDARD DELIVERY

Main unit	1pc
Flat anvil	1pc
V-type anvil	1pc
Spherical anvil	1pc
Ø10mm carbide ball	2pcs
Brinell test block	2pcs
Measuring microscope	1pc

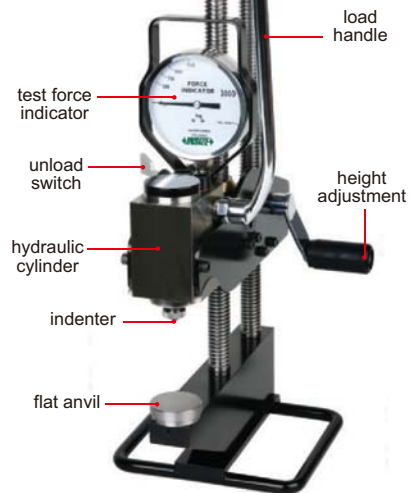

V-type anvil (included)



spherical anvil (included)



measuring microscope (included)

CHAIN TYPE HYDRAULIC BRINELL HARDNESS TESTER CODE ISHB-C161



measuring microscope (included)

- To measure the hardness of cylinders or tubes
- According to ISO 6506, ASTM E10



SPECIFICATION

Measuring range	32~650HBW
Workpiece diameter range	Ø150~Ø500mm
Test force	3000kg
Indenter	Ø10mm carbide ball
Measuring microscope	20X, graduation 0.01mm
Dimension	270×225×570mm
Weight	14.5kg

STANDARD DELIVERY

Main unit	1pc
1.5m chain	1pc
Ø10mm carbide ball	2pcs
Brinell test block	2pcs
Measuring microscope	1pc

BARCOL HARDNESS TESTER CODE ISHB-B300



- To measure the hardness of thick workpieces made of pure aluminum, aluminum alloy, fiber reinforced plastic, hard plastic, etc.
- According to ASTM B648-00, ASTM D2853-07



SPECIFICATION

Hardness range	0~100HBa (equal to 25~150HBW)
Min. reading	1HBa
Accuracy	±2HBa (at 42~52HBa) ±1HBa (at 84~88HBa)
Min. workpiece thickness	0.8mm
Dimension	142×65×90mm
Weight	500g

STANDARD DELIVERY

Main unit	1pc
Spare indenter	2pcs
Hardness test block	2pcs
Wrench	1pc

WEBSTER HARDNESS TESTERS

- To measure the hardness of soft metal such as aluminum alloy, copper, brass, soft steel, etc.
- According to ASTM B647-84 (2000)



VIDEO

STANDARD DELIVERY

Main unit	1pc
Spare indenter	1pc
Hardness test block	1pc
Wrench	1pc



ISHW-L20

SPECIFICATION

Code	ISHW-L20	ISHW-L20A	ISHW-L20B	ISHW-B70	ISHW-B75	ISHW-B92
Application	for aluminum alloy general use	for aluminum alloy thick workpiece	for aluminum alloy small tube	for hard aluminum alloy and hard brass	for soft brass and copper	for soft steel and cold-rolled steel
Thickness requirement of flat workpiece	0.6~6mm	0.6~13mm	0.6~8mm	0.6~6mm	0.6~6mm	0.6~6mm
Internal diameter requirement of tube workpiece	>Ø10mm	>Ø10mm	>Ø6mm	>Ø10mm	>Ø10mm	>Ø10mm
Wall thickness requirement of tube workpiece	0.6~6mm	6~13mm (internal diameter Ø10~23.3mm) 0.6~6mm (internal diameter >Ø23.3mm)	0.6~8mm	0.6~6mm	0.6~6mm	0.6~6mm
Hardness range	0~20HW					
Min. reading	1HW					
Accuracy	±0.5HW (at 5~17HW)					
Dimension	205×30×85mm					
Weight	500g					

DIGITAL SHORE DUROMETERS

- According to ISO868, ISO7619, ASTM D 2240
- Average and peak (max.) mode
- Dwell time is adjustable
- Low and high limits with judgement
- 500 memories
- Wireless connection to printer
- Handhold use or work with test stand (code ISH-DS-STAND)
- Automatic power off

DATA OUTPUT



VIDEO

SPECIFICATION

Code	ISH-DSA	ISH-DSD
Unit	Shore A	Shore D
Test material	soft plastic, soft rubber, etc.	hard plastic, hard rubber, etc.
Measuring range*	0~100HA	0~100HD
Resolution	0.1HA	0.1HD
Accuracy	±1HA	±1HD
Indenter protrusion	2.5mm	
Output	wireless and USB	
Power supply	built-in rechargeable battery	
Dimension	153×50×29mm	
Weight	170g	

STANDARD DELIVERY

Main unit	1pc
Calibration block	1pc
USB cable and software	1pc
AC/DC adapter	1pc

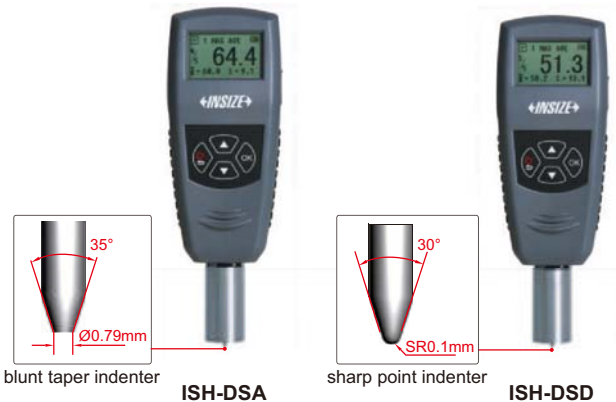

blunt taper indenter

ISH-DSA

sharp point indenter

ISH-DSD



software CD (included)



calibration block (included)



printer (optional)

OPTIONAL ACCESSORY

Printer	ISH-DS-PRINTER
Test stand	ISH-DS-STAND
1kg weight block (for ISH-DSA)	ISH-DSA-W1
5kg weight block (for ISH-DSD)	ISH-DSD-W5

- * Use ISH-DSD when measuring result is higher than 90HA
Use ISH-DSA when measuring result is lower than 20HD



TEST STAND FOR DIGITAL SHORE DUROMETERS CODE ISH-DS-STAND

- For digital shore durometers (code **ISH-DSA** and **ISH-DSD**)
- Can perform repeatable hardness measurement due to fewer possibilities of human error or measurement variations
- 1kg weight block is for **ISH-DSA**, 5kg weight block is for **ISH-DSD**

SPECIFICATION

Stage diameter	Ø88mm
Maximum workpiece height	75mm
Dimension	125×163×350mm
Weight	4kg

STANDARD DELIVERY

Test stand	1pc
Durometer supporter	1pc

OPTIONAL ACCESSORY

1kg weight block (for ISH-DSA)	ISH-DSA-W1
5kg weight block (for ISH-DSD)	ISH-DSD-W5



5kg weight block (optional) for ISH-DSD



SHORE DUROMETERS

- According to ISO868, ISO7619, ASTM D 2240
- With peak value indicator
- Handhold use or work with test stand (code **ISH-OS2**)

SPECIFICATION

Code	ISH-S30A	ISH-S30D
Scale	Shore A	Shore D
Test material	soft plastic, soft rubber, etc.	hard plastic, hard rubber, etc.
Measuring range*	0~100HA	0~100HD
Resolution	1HA	1HD
Accuracy	±0.5HA	±0.5HD
Indenter protrusion	2.5mm	
Bezel diameter	57mm	
Overall height	121mm	
Weight	184g	

* Use **ISH-S30D** when measuring result is higher than 90HA
Use **ISH-S30A** when measuring result is lower than 20HD

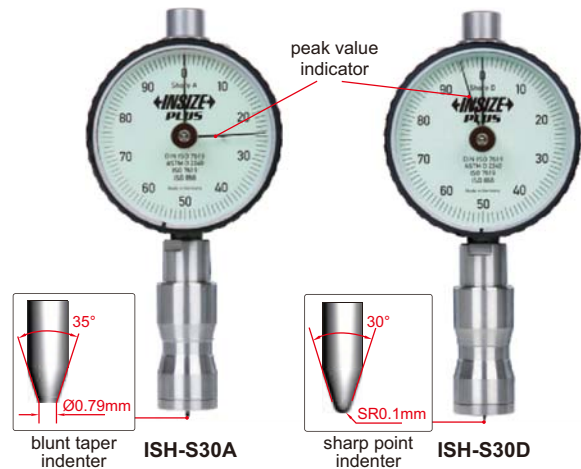

HARDNESS TEST BLOCKS FOR SHORE DUROMETERS

SPECIFICATION

Code	ISH-S30A-BLOCK	ISH-S30D-BLOCK
Type	Shore A	Shore D
Hardness value	7pcs/set: 30, 40, 50, 60, 70, 80, 90HA	3pcs/set: 60, 75, 85HD



ISH-S30A-BLOCK



ISH-S30D-BLOCK

TEST STAND FOR SHORE DUROMETERS CODE ISH-OS2

- For shore durometers (code **ISH-S30A** and **ISH-S30D**)
- Can perform repeatable hardness measurement due to fewer possibilities of human error or measurement variations
- Special structure for stable loading
- 1kg weight block is for **ISH-S30A**, 4kg weight block is for **ISH-S30D**

SPECIFICATION

Stage diameter	Ø98mm
Maximum workpiece height	180mm
Maximum workpiece depth	115mm (from test point to column)
Weight block	1kg (for ISH-S30A)
Dimension	Ø200×500mm
Weight	18kg

STANDARD DELIVERY

Test stand	1pc
Calibration block	1pc

OPTIONAL ACCESSORY

4kg weight block (for ISH-S30D)	ISH-OS2-W4
---	-------------------

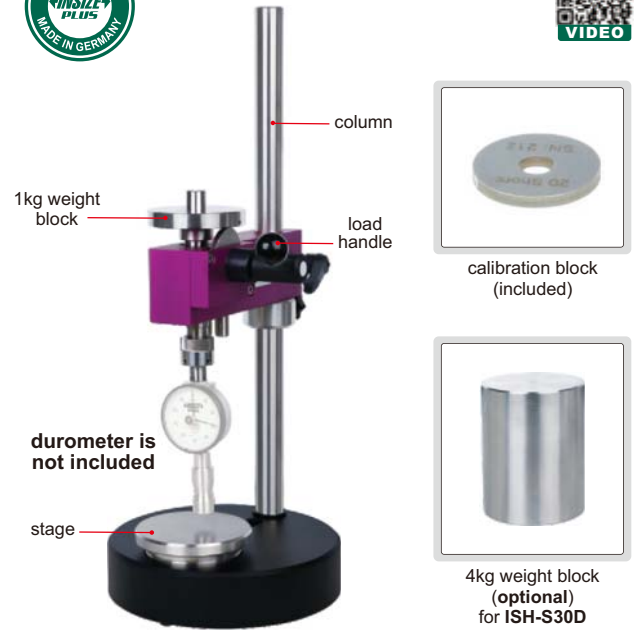

SHORE DUROMETERS



- According to ISO868, ISO7619, ASTM D 2240
- With peak value indicator
- Optional accessory: test stand **ISH-STAC** and **ISH-STD**

SPECIFICATION

Code	ISH-SAM	ISH-SDM
Scale	Shore A	Shore D
Application	nature rubber, soft elastomer, etc.	hard rubber, plastic, hard elastomer, etc.
Measuring range*	10~90HA	20~90HD
Graduation	1HA	1HD
Indenter protrusion	2.5mm	
Dimension	115×60×25mm	
Weight	160g	

- * Use **ISH-SDM** when measuring result is higher than 90HA
Use **ISH-SAM** when measuring result is lower than 20HD

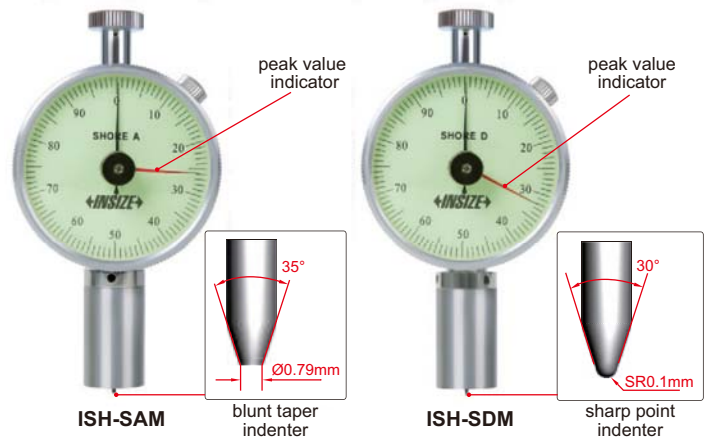

TEST STANDS FOR SHORE DUROMETERS



- For shore durometers (code **ISH-SAM** and **ISH-SDM**)
- Perform repeatable hardness measurement due to fewer possibilities of human error or measurement variations

SPECIFICATION

Code	ISH-STAC	ISH-STD
Applicable durometer	ISH-SAM	ISH-SDM
Stage diameter	Ø100mm	Ø100mm
Maximum workpiece height	75mm	75mm
Weight block	1kg	5kg

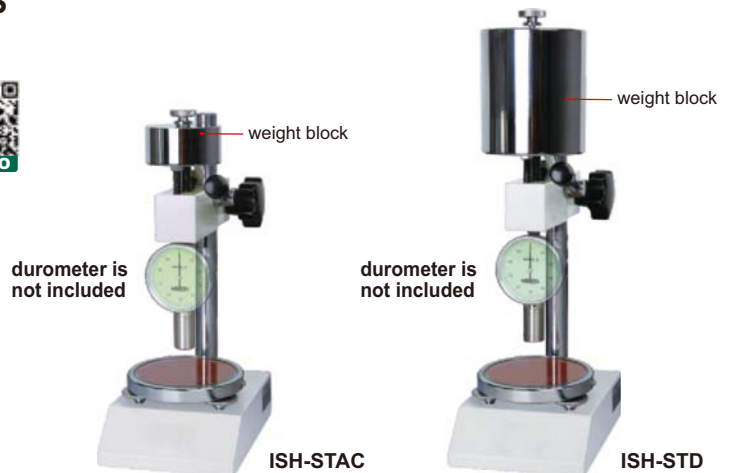



DIGITAL FORCE GAGES

- Push and pull test
- Units: N, gf, kgf, ozf, lbf
- 500 memories
- Automatic power off
- Metal case
- LCD display with backlight, can turn 180°
- Overload alarm

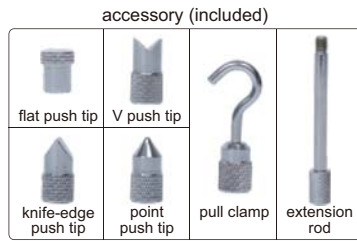

ISF-1DF100

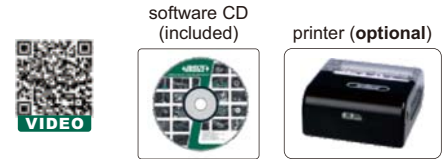

STANDARD DELIVERY

Main unit	1pc
AC/DC adapter	1pc
USB cable and software	1pc
Push/pull accessory	6pcs (flat push tip, V push tip, knife-edge push tip, point push tip, pull clamp, extension rod)

OPTIONAL ACCESSORY

Printer	ISF-DF-PRINTER
Test stand	ISF-MT1K

SPECIFICATION

Code	ISF-1DF10	ISF-1DF50	ISF-1DF100	ISF-1DF500	ISF-1DF1000
Load capacity (N)	10	50	100	500	1000
Resolution (N)	0.01	0.01	0.1	0.1	1
Accuracy	±0.3% (of load capacity)				
Measuring mode	tracking, peak (max.), low and high limits with judgement				
Power supply	built-in rechargeable battery				
Dimension	150×73×33mm				
Weight	450g				



DIGITAL FORCE GAGES (HIGH ACCURACY)



- Push and pull test
- Peak (max.) and tracking mode
- Units: mN, N, gf, kgf, ozf, lbf, MPa (only for type B)
- Low and high limits with judgement
- 1000 memories
- Automatic power off
- Metal case, touch buttons
- LCD display with backlight, can automatically turn 180°
- Overload alarm



ISF-DF100A
type A

ISF-DF5KA
type B

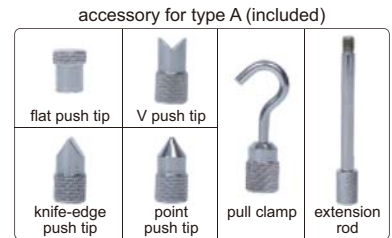

SPECIFICATION

Code	ISF-DF 5A	ISF-DF 10A	ISF-DF 20A	ISF-DF 50A	ISF-DF 100A	ISF-DF 200A	ISF-DF 500A	ISF-DF 1KA	ISF-DF 2KA	ISF-DF 5KA	ISF-DF 10KA	ISF-DF 20KA
Type	A (internal sensor)								B (external sensor)			
Load capacity (N)	5	10	20	50	100	200	500	1000	2000	5000	10000	20000
Resolution (N)	0.0005	0.001	0.005	0.005	0.01	0.05	0.05	0.1	0.5	0.5	1	5
Accuracy	±0.2% (of load capacity)											
Power supply	built-in rechargeable battery											

STANDARD DELIVERY

Code	ISF-DF 5A	ISF-DF 10A	ISF-DF 20A	ISF-DF 50A	ISF-DF 100A	ISF-DF 200A	ISF-DF 500A	ISF-DF 1KA	ISF-DF 2KA	ISF-DF 5KA	ISF-DF 10KA	ISF-DF 20KA
Main unit	1pc								1pc			
AC/DC adapter	1pc								1pc			
USB cable and software	1pc								1pc			
Push/pull accessory	6pcs (flat push tip, V push tip, knife-edge push tip, point push tip, pull clamp, extension rod)								4pcs (flat push tip, adapter, pull clamps)			

OPTIONAL ACCESSORY

Printer	ISF-DF-PRINTER
Test stand	ISF-MT1K

TEST STAND FOR DIGITAL FORCE GAGES CODE ISF-MT1K

- For digital force gages (code ISF-1DFxx and ISF-DFxx)
- To be used in vertical and horizontal orientation



horizontal orientation test



digital scale (optional)



force gages are not included



SPECIFICATION

Load capacity	1000N
Travel	200mm (3mm vertical movement per revolution of handwheel)
Dimension	196 x 250 x 446mm
Weight	13kg

OPTIONAL ACCESSORY

Digital scale (range: 200mm, resolution: 0.01mm/0.0005")

ISF-MT1K-SCALE

FORCE GAGES

SPECIFICATION

Code	ISF-F10	ISF-F20	ISF-F30	ISF-F50	ISF-F100	ISF-F200	ISF-F300	ISF-F500	
Capacity	N	10	20	30	50	100	200	300	500
	kgf	1	2	3	5	10	20	30	50
Graduation	N	0.05	0.1	0.2	0.25	0.5	1	2	2.5
Accuracy	±1% (of load capacity)								



ISF-F500



STANDARD DELIVERY

Main unit	1pc
Push tip	4pcs (flat, V type, knife-edge, point)
Pull clamp	1pc
Extension rod	1pc

OPTIONAL ACCESSORY

Test stand ISF-MT500

- Push and pull test
- Peak (max.) or tracking mode



flat push tip (included)



V type push tip (included)



knife-edge push tip (included)



point push tip (included)



pull clamp (included)



extension rod (included)

TEST STAND FOR FORCE GAGES CODE ISF-MT500

- For force gages (code ISF-Fxx)
- To be used in vertical and horizontal orientation



horizontal orientation test



force gages are not included



SPECIFICATION

Load capacity	500N
Travel	150mm (3mm vertical movement per revolution of handwheel)
Dimension	160×240×460mm
Weight	12kg

DIAL TENSION GAGES

SPECIFICATION (Unit: N)

Code	ISF-TGD1	ISF-TGD3	ISF-TGD5	ISF-TG1	ISF-TG1D5	ISF-TG3	ISF-TG5
Capacity (N)	0.1	0.3	0.5	1	1.5	3	5
Graduation (N)	0.002	0.005	0.01	0.02	0.025	0.05	0.1
Accuracy	±2% (full scale)						
Dimension (L×W×H)	90×47×19mm						
Weight	60g						

SPECIFICATION (Unit: gf)

Code	ISF-TG10	ISF-TG30	ISF-TG50	ISF-TG100	ISF-TG150	ISF-TG300	ISF-TG500
Capacity (gf)	10	30	50	100	150	300	500
Graduation (gf)	0.2	0.5	1	2	2.5	5	10
Accuracy	±2% (full scale)						
Dimension (L×W×H)	90×47×19mm						
Weight	60g						



ISF-TG3

- Clockwise and counter-clockwise use
- For electronic and precision mechanical industry, such as measure contact pressure of relay, adjust the tension or compression of spring

DATA OUTPUT

ATTENTION: NOT SUITABLE FOR ELECTRIC WRENCHES, IMPACT WRENCHES OR PNEUMATIC WRENCHES



DIGITAL TORQUE TESTERS

- With external sensor, to test torque wrenches, torque screwdrivers and other torque tools
- Clockwise and counter-clockwise operation
- Peak, track and first peak working modes
- Unit: cN.m, in.lb, kg.cm
- Low and high limits with judgement
- Target torque value can be set (10 target torque values can be saved and selected quickly), with audible and visible alarm:
 - Green LED light on and buzzer sounds when the value is 80%~100% of target torque
 - Both green and red LED light on and buzzer sounds when the target torque value is reached
- Memory of 2000 measurement values for browsing and output
- Automatic power off

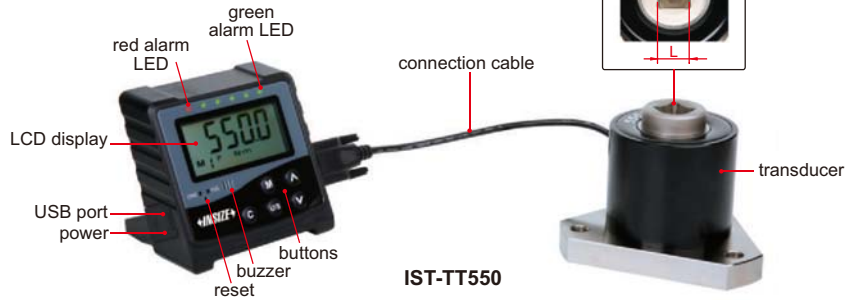

SPECIFICATION

Code	IST-TT5	IST-TT50	IST-TT220	IST-TT550	IST-TT2200
Range	0.5~5N.m	5~50N.m	22~220N.m	55~550N.m	220~2200N.m
Accuracy	±1% (clockwise and counter-clockwise)				
Resolution	0.001N.m	0.01N.m	0.1N.m	0.1N.m	1N.m
Square socket (L)	1/4"	3/8"	1/2"	3/4"	1"
Power supply	DC				
Adaptor	no	3/8" to 1/4"	1/2" to 3/8" 3/8" to 1/4"	3/4" to 1/2" 1/2" to 3/8"	1" to 3/4" 3/4" to 1/2"
Transducer dimension	60×60×47 mm	89×89×65 mm	109×109×73 mm	140×140×97 mm	160×160×116 mm
Weight	0.7kg	1.1kg	1.4kg	2.8kg	4.7kg



STANDARD DELIVERY

Main unit	1pc
Transducer with 1m cable	1pc
AC/DC adaptor	1pc
USB cable and software	1pc
Adaptor	refer to the left

TORQUE WRENCH TEST STAND
CODE IST-TS500



application example



digital torque tester (optional)



adaptor (optional, for digital torque tester IST-TT5, IST-TT50, IST-TT220)

- Work with digital torque testers (IST-TT5, IST-TT50, IST-TT220, IST-TT550)

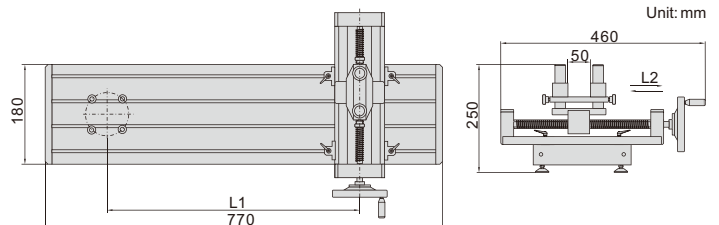

SPECIFICATION

Digital torque tester	IST-TT5 (optional)	IST-TT50 (optional)	IST-TT220 (optional)	IST-TT550 (optional)
Applicable torque wrenches	0.5~5N.m	5~50N.m	22~220N.m	220~340N.m
Arm length (L1)	150~550mm, adjustable			
Maximum travel (L2)	200mm			
Weight	12kg			

OPTIONAL ACCESSORY

Digital torque tester	IST-TT5, IST-TT50, IST-TT220, IST-TT550
Adaptor	IST-TS500-BLOCK (necessary for IST-TT5, IST-TT50 and IST-TT220, not needed for IST-TT550)

DIGITAL BOTTLE CAP TORQUE TESTERS

- Measure the open and tighten torque of bottle cap
- Unit: N.m, N.cm, kgf.cm, lbf.in, lbf.ft
- 1500 memories
- Wireless connection to printer
- Automatic power off
- LCD display with backlight
- Overload alarm
- With calibration function



DATA OUTPUT

SPECIFICATION

Code	IST-DCT2	IST-DCT5	IST-DCT10	IST-DCT20
Load capacity	2N.m	5N.m	10N.m	20N.m
Resolution	0.001N.m	0.001N.m	0.01N.m	0.01N.m
Clamping range	Ø19.5~190mm			
Accuracy	±0.5% (of load capacity)			
Measuring mode	tracking, peak (max.), first peak, double peak, low and high limits with judgement			
Output	wireless and USB			
Power supply	built-in rechargeable battery			
Dimension	200×197×142mm			
Weight	2.5kg			

two display modes

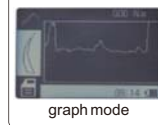

IST-DCT20

STANDARD DELIVERY

Main unit	1pc
AC/DC adapter	1pc
USB cable and software	1pc

OPTIONAL ACCESSORY

Printer	ISH-DS-PRINTER
---------	----------------

DIGITAL TORQUE SCREWDRIVERS

- Clockwise and counter-clockwise operation
- Unit: cN.m, in.lb, kg.cm
- Peak and track working mode
- Target torque value can be set, with audible and visible alarm:
 - Green LED light on and buzzer sounds when target torque value is 90%~100% of target torque
 - Red LED light on and buzzer sounds when target torque value is reached
- Power off automatically in 5 minutes without any operations



SPECIFICATION

Code	IST-SD50	IST-SD200	IST-SD400
Range	10~50cN.m	40~200cN.m	80~400cN.m
Accuracy	clockwise	±3%	±2.5%
	counter-clockwise	±4%	±3.5%
Resolution	0.1cN.m	0.1cN.m	0.1cN.m
Size of hex socket (L)	1/4"	1/4"	1/4"
Power supply	1×AAA battery		
Length	193mm	203mm	203mm
Weight	190g	200g	200g



IST-SD200

OPTIONAL ACCESSORY

Calibration cable	IST-SD-CABLE
-------------------	--------------

SMALL RANGE TORQUE SCREWDRIVERS

- According to DIN ISO 6789, ASME B107.300-2010



SPECIFICATION

Code	IST-MH1D2	IST-MS1D2
Head type	hex socket	square driver
Range (clockwise)	0.1~1.2N.m	0.1~1.2N.m
Graduation	0.01N.m	0.01N.m
Accuracy	±6%	±6%
Length	180mm	180mm
Weight	230g	230g

ACCURACY ±6%

ATTENTION: CLOCKWISE OPERATION ONLY



ATTENTION: CLOCKWISE OPERATION ONLY

ACCURACY ±6%

INSPECTION CERTIFICATE



VIDEO

TORQUE SCREWDRIVERS

1/4" square socket, for T-bar wrench

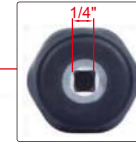

lock ring for torque setting
torque value



hex socket

IST-MH9

lock ring for torque setting
torque value

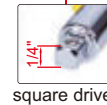

square driver

IST-MS9

Set torque:



step 1: lift the lock ring



step 2: rotate the handle to set torque



step 3: release the lock ring



T-bar wrench (optional)

SPECIFICATION

Code	IST-MH3D5	IST-MH6	IST-MH9	IST-MH10	IST-MS3D5	IST-MS6	IST-MS9	IST-MS10
Range (clockwise)	1~3.5N.m	1~6N.m	4~9N.m	5~10N.m	1~3.5N.m	1~6N.m	4~9N.m	5~10N.m
Graduation	0.05N.m	0.1N.m	0.1N.m	0.1N.m	0.05N.m	0.1N.m	0.1N.m	0.1N.m
Head type	hex socket				square driver			
Accuracy	±6%				±6%			
Length	200mm				200mm			
Weight	300g				300g			

OPTIONAL ACCESSORY

T-bar wrench	IST-M-T BAR
--------------	-------------

INSPECTION CERTIFICATE

- Clockwise and counter-clockwise operation
- Unit: N.m, in.lb, ft.lb, kg.cm
- Peak and track working mode
- Target torque value can be set, with audible and visible alarm:
 - Green LED light on and buzzer sounds when target torque value is 90%~100% of target torque
 - Red LED light on and buzzer sounds when target torque value is reached
- Power off automatically in 5 minutes without any operations
- Non-slip grip handle
- With overload record (once the torque reaches 110% of the maximum range)

SMALL RANGE DIGITAL TORQUE WRENCHES

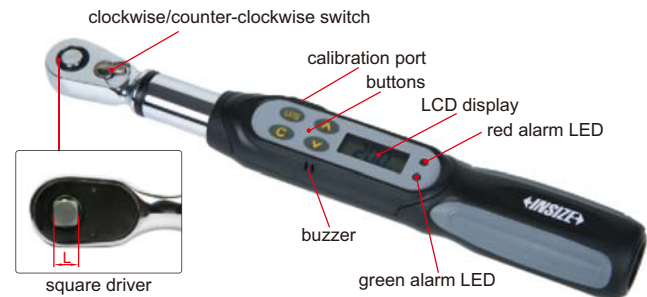

IST-WP20



VIDEO

SPECIFICATION

Code	IST-WP6	IST-WP12	IST-WP20
Range	1.2~6N.m	2.4~12N.m	4~20N.m
Accuracy	clockwise	±3%	±3%
	counter-clockwise	±4%	±4%
Resolution	0.001N.m	0.01N.m	0.01N.m
Square driver (L)	1/4"	1/4"	1/4"
Power supply	1×AAA battery		
Length	260mm	260mm	260mm
Weight	430g	430g	430g

OPTIONAL ACCESSORY

Calibration cable	IST-SD-CABLE
-------------------	--------------

SHORT HANDLE DIGITAL TORQUE WRENCHES

- Clockwise and counter-clockwise operation
- Unit: N.m, in.lb, ft.lb, kg.cm
- Peak and track working mode
- Target torque value can be set, with audible and visible alarm:
 - Green LED light on and buzzer sounds when torque value is 90%~100% of target torque
 - Both green and red LED light on and buzzer sounds when target torque value is reached
- Power off in 5 minutes automatically
- Non-slip grip handle
- With damp record
- With overload record (once the torque reaches 110% of the maximum range)



IST-WS60

SPECIFICATION

Code	IST-WS30	IST-WS30A	IST-WS60	IST-WS85
Range	6~30N.m	6~30N.m	12~60N.m	17~85N.m
Accuracy	clockwise	±3%		
	counter-clockwise	±4%		
Resolution	0.01N.m	0.01N.m	0.01N.m	0.1N.m
Square driver (L)	1/4"	3/8"	3/8"	3/8"
Power supply	2×AAA batteries			
Length	215mm	215mm	225mm	271mm
Weight	750g	830g	917g	1000g



VIDEO

OPTIONAL ACCESSORY

Calibration cable IST-SD-CABLE

WIRELESS DATA TRANSFER DIGITAL TORQUE WRENCHES

- Wireless data transfer to computer
- Unit: N.m, in.lb, ft.lb, kg.cm
- Clockwise and counter-clockwise operation
- Peak and track working mode
- Can set tolerance with judgement in peak working mode
- 9 target torque values can be set, with audible and visible alarm:
 - Green LED light on and buzzer sounds when torque value is 80%~99.5% of target torque
 - Both green and red LED light on and buzzer sounds when torque value is over 99.5% of target torque
- Power off in 2 minutes automatically
- Non-slip grip handle
- With damp record
- With overload record (once the torque reaches 110% of the maximum range)

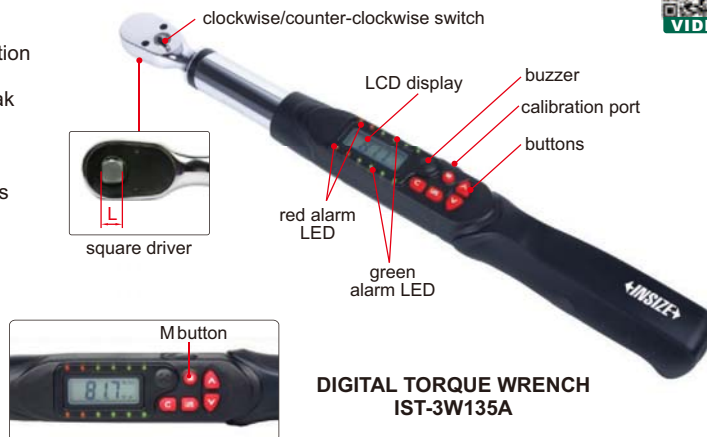

DIGITAL TORQUE WRENCH
IST-3W135A



VIDEO



RECEIVER
IST-3WREC

DIGITAL TORQUE WRENCH SPECIFICATION

Code	IST-3W30A	IST-3W135A	IST-3W200A	IST-3W340A
Range	6~30N.m	27~135N.m	40~200N.m	68~340N.m
Accuracy	clockwise	±2%		
	counter-clockwise	±3%		
Tolerance setting range	-25% ~ +25% (target torque value)			
Resolution	0.01N.m	0.1N.m	0.1N.m	0.1N.m
Square driver (L)	1/4"	3/8"	1/2"	1/2"
Working frequency	ISM433MHz (432.0~433.8MHz, adjustable)			
Power supply	2xAA batteries, for 110 hours working			
Length	390mm	415mm	530mm	650mm
Weight	760g	940g	1340g	1540g

RECEIVER SPECIFICATION

Code	IST-3WREC
Working frequency	ISM433MHz (432.0~433.8MHz adjustable)
Power supply	DC 24V, 0.5A
Dimension	200×108×31mm
Weight	500g

OPTIONAL ACCESSORY

Calibration cable IST-SD-CABLE

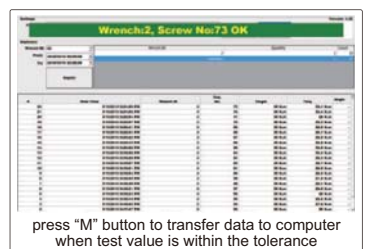



DIGITAL TORQUE WRENCHES

- Clockwise and counter-clockwise operation
- Unit: N.m, in.lb, ft.lb, kg.cm
- Peak and track working mode
- Target torque value can be set, with audible and visible alarm:
 - Green LED light on and buzzer sounds when torque value is 90%~100% of target torque
 - Both green and red LED light on and buzzer sounds when target torque value is reached
- Power off automatically in 5 minutes without any operations
- Non-slip grip handle
- With damp record
- With overload record (once the torque reaches 110% of the maximum range)



IST-W135A

SPECIFICATION

Code	Range	Accuracy	Resolution	Square driver (L)	Power supply	Length	Weight
IST-W30A	6~30N.m	clockwise: $\pm 2\%$ counter-clockwise: $\pm 3\%$	0.01N.m	1/4"	2xAA batteries	390mm	830g
IST-W135A	27~135N.m		0.1N.m	3/8"		415mm	950g
IST-W200A	40~200N.m		0.1N.m	1/2"		530mm	1.4kg
IST-W340A	68~340N.m	clockwise: $\pm 2.5\%$ counter-clockwise: $\pm 3.5\%$	0.1N.m	1/2"		650mm	1.6kg
IST-W500A	100~500N.m		0.1N.m	3/4"		950mm	2.1kg
IST-W850A	170~850N.m		0.1N.m	3/4"		1220mm	2.55kg
IST-W1200A	240~1200N.m		1N.m	1"		1800mm	13kg
IST-W1500A	300~1500N.m		1N.m	1"		1800mm	13kg
IST-W2000A	400~2000N.m	1N.m	1"	1800mm		14kg	

OPTIONAL ACCESSORY

Calibration cable	IST-W-CABLE
-------------------	-------------

DIGITAL ANGLE TORQUE WRENCHES

- Clockwise and counter-clockwise operation
- Set the desired torque first. After reaching the desired torque, set the angle and turn the wrench at this angle to apply extra torque
- Unit: N.m, in.lb, ft.lb, kg.cm, degree
- Peak and track working mode
- Target torque or angle value can be set, with audible and visible alarm:
 - Green LED light on and buzzer sounds when torque or angle value is 90%~100% of target torque or angle
 - Both green and red LED light on and buzzer sounds when target torque or angle value is reached
- Power off in 5 minutes automatically
- Non-slip grip handle
- With damp record
- With overload record (once the torque reaches 110% of the maximum range)

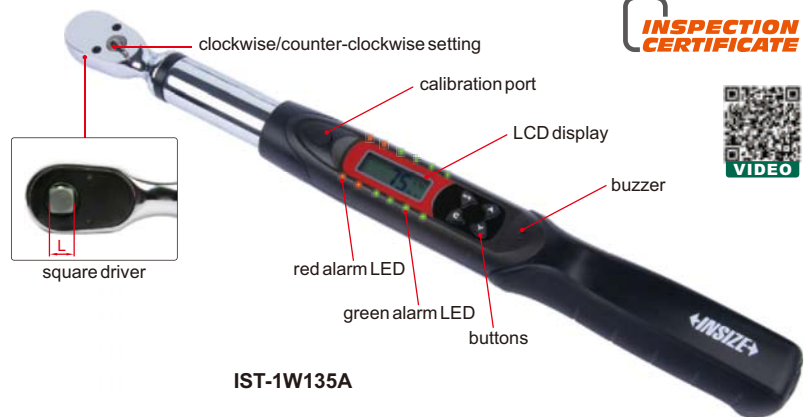

IST-1W135A

SPECIFICATION

Code	IST-1W30A	IST-1W135A	IST-1W200A	IST-1W340A
Range	torque	6~30N.m	27~135N.m	40~200N.m
	angle	0~999°		
Accuracy	clockwise	$\pm 2\%$		
	counter-clockwise	$\pm 3\%$		
	angle	$\pm 2^\circ$ (rotate 90°)		
Resolution	torque	0.01N.m	0.1N.m	0.1N.m
	angle	1°		
Square driver (L)	1/4"	3/8"	1/2"	1/2"
Power supply	2xAA batteries, for 110 hours working			
Length	390mm	415mm	530mm	650mm
Weight	830g	950g	1400g	1600g



Set the desired torque first. After reaching the desired torque, set the angle and turn the wrench at this angle to apply extra torque

OPTIONAL ACCESSORY

Calibration cable	IST-W-CABLE
-------------------	-------------

INTERCHANGEABLE HEAD DIGITAL TORQUE WRENCHES

- Clockwise and counter-clockwise operation
- Unit: N.m, in.lb, ft.lb, kg.cm, degree
- Peak and track working mode
- Target torque value can be set, with audible and visible alarm:
 - Green LED light on and buzzer sounds when torque value is 90%~100% of target torque
 - Both green and red LED light on and buzzer sounds when target torque value is reached
- Power off in 5 minutes automatically without any operations
- Non-slip grip handle
- With damp record
- With overload record (once the torque reaches 110% of the maximum range)

**INSPECTION
CERTIFICATE**

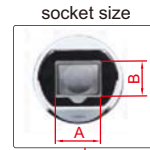

IST-2W135A

SPECIFICATION

Code	IST-2W30A	IST-2W135A	IST-2W200A	IST-2W340A
Range	6~30N.m	27~135N.m	40~200N.m	68~340N.m
Accuracy	clockwise	±2%		
	counter-clockwise	±3%		
Resolution	0.01N.m	0.1N.m	0.1N.m	0.1N.m
Socket size (A×B)	12×9mm	12×9mm	18×14mm	18×14mm
Arm length (L1)	272.7mm	287.7mm	381.2mm	501.2mm
Power supply	2xAA batteries, for 110 hours working			
Weight	1400g	1570g	2170g	2320g

RATCHET HEAD (INCLUDED) SPECIFICATION

Code of torque wrench	IST-2W30A	IST-2W135A	IST-2W200A	IST-2W340A
Square driver (D)	1/4"	3/8"	1/2"	1/2"
Length (L2)	29mm	29mm	40mm	40mm

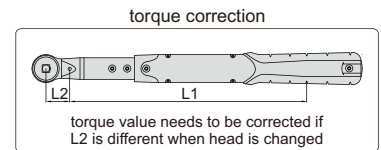

STANDARD DELIVERY

Torque wrench	1 pc
Ratchet head	1 pc

OPTIONAL ACCESSORY

Calibration cable	IST-W-CABLE
Interchangeable head	see details



RATCHET HEAD (optional)

Code	Square driver (D)	Applicable wrenches
IST-2W-R1	1/4"	IST-2W30A
IST-2W-R2	3/8"	IST-2W135A
IST-2W-R3	1/2"	IST-2W135A
IST-2W-R4	1/2"	IST-2W200A IST-2W340A



BOX END HEAD (optional)

Code	Open size	Applicable wrenches	
IST-2W-M7	7mm	IST-2W30A IST-2W135A	
IST-2W-M8	8mm		
IST-2W-M10	10mm		
IST-2W-M11	11mm		
IST-2W-M12	12mm		
IST-2W-M13	13mm		
IST-2W-M14	14mm		
IST-2W-M15	15mm		
IST-2W-M16	16mm		
IST-2W-M17	17mm		
IST-2W-M18	18mm		
IST-2W-M19	19mm		
IST-2W-M21	21mm		IST-2W200A IST-2W340A
IST-2W-M22	22mm		
IST-2W-M13A	13mm		
IST-2W-M14A	14mm		
IST-2W-M15A	15mm		
IST-2W-M16A	16mm		
IST-2W-M17A	17mm		
IST-2W-M18A	18mm		
IST-2W-M19A	19mm		
IST-2W-M21A	21mm		



OPEN END HEAD (optional)

Code	Open size	Applicable wrenches	
IST-2W-K7	7mm	IST-2W30A IST-2W135A	
IST-2W-K8	8mm		
IST-2W-K9	9mm		
IST-2W-K10	10mm		
IST-2W-K11	11mm		
IST-2W-K12	12mm		
IST-2W-K13	13mm		
IST-2W-K14	14mm		
IST-2W-K15	15mm		
IST-2W-K16	16mm		
IST-2W-K17	17mm		
IST-2W-K18	18mm		
IST-2W-K19	19mm		
IST-2W-K13A	13mm		IST-2W200A IST-2W340A
IST-2W-K14A	14mm		
IST-2W-K15A	15mm		
IST-2W-K16A	16mm		
IST-2W-K17A	17mm		
IST-2W-K18A	18mm		
IST-2W-K19A	19mm		
IST-2W-K21A	21mm		
IST-2W-K22A	22mm		
IST-2W-K24A	24mm		



ADJUSTABLE SPANNER HEAD (optional)

Code	Open size	Applicable wrenches
IST-2W-A1	5~27mm	IST-2W135A
IST-2W-A2	5~30mm	IST-2W200A
IST-2W-A3	10~41mm	IST-2W340A



MEASURE THE TORQUE OF TIGHTENED BOLT

QUALITY INSPECTION TORQUE WRENCHES



- Measure the torque of tightened bolt with retightening method, read the torque value when the looseness is detected
- Two measuring modes:
 - M1: automatic detecting mode, for normal bolts retighten the bolt, the torque value is displayed on screen when the wrench automatically detects the looseness, both green and red LED light on and buzzer sounds
 - M2: manual detecting mode, for long bolts retighten the bolt, read the torque value when the looseness is detected by hand
- Unit: N.m, in.lb, ft.lb, kg.cm
- Peak and track working mode (only for M2 measuring mode)
- Clockwise and count-clockwise operation
- Memory of 50 results
- Power off in 15 minutes automatically
- Non-slip grip handle
- With overload record (once the torque reaches 110% of the maximum range)



IST-4W135A

SPECIFICATION

Code	IST-4W30A	IST-4W135A	IST-4W200A	IST-4W340A
Range	6~30N.m	27~135N.m	40~200N.m	68~340N.m
Accuracy	clockwise	±2%		
	counter-clockwise	±3%		
Resolution	0.01N.m	0.1N.m	0.1N.m	0.1N.m
Square driver (L)	1/4"	3/8"	1/2"	1/2"
Power supply	2xAA batteries, for 110 hours working			
Length	390mm	415mm	530mm	650mm
Weight	760g	940g	1340g	1540g

OPTIONAL ACCESSORY

Calibration cable	IST-W-CABLE
-------------------	-------------



ACCURACY ±3%

ATTENTION: CLOCKWISE OPERATION ONLY

TORQUE WRENCHES



- According to DIN ISO 6789, ASME B107.300-2010

Set torque:

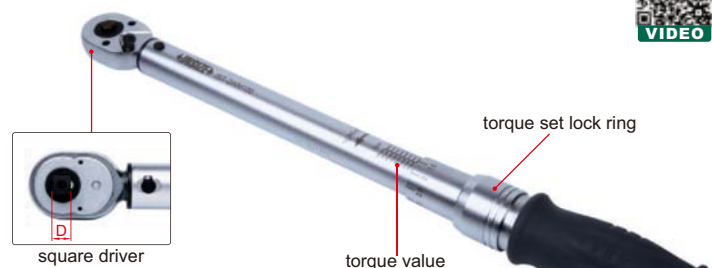
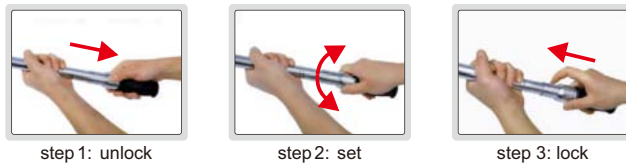

IST-2WM100

SPECIFICATION

Code	IST-2WM25	IST-2WM60	IST-2WM100	IST-2WM200	IST-2WM340	IST-2WM600	IST-2WM800
Range (clockwise)	5~25N.m	10~60N.m	20~100N.m	40~200N.m	60~340N.m	100~600N.m	150~800N.m
Accuracy	±3%	±3%	±3%	±3%	±3%	±3%	±3%
Graduation	0.2N.m	0.5N.m	0.5N.m	1N.m	2N.m	5N.m	5N.m
Square driver (D)	1/4"	3/8"	3/8"	1/2"	1/2"	3/4"	3/4"
Length	281mm	337mm	436mm	512mm	614mm	1050mm	1240mm
Weight	590g	760g	1320g	1580g	1800g	5030g	6110g

INTERCHANGEABLE HEAD TORQUE WRENCHES

ATTENTION: CLOCKWISE OPERATION ONLY

ACCURACY $\pm 3\%$

INSPECTION CERTIFICATE



IST-6WM100

■ According to DIN ISO 6789, ASME B107.300-2010

Set torque:



step 1: unlock



step 2: set



step 3: lock

torque correction

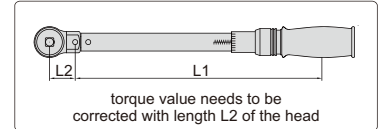

SPECIFICATION

Code	IST-6WM60	IST-6WM100	IST-6WM200	IST-6WM340	IST-6WM600
Range (clockwise)	10~60N.m	20~100N.m	40~200N.m	60~340N.m	100~600N.m
Accuracy	$\pm 3\%$	$\pm 3\%$	$\pm 3\%$	$\pm 3\%$	$\pm 3\%$
Graduation	0.5N.m	0.5N.m	1N.m	2N.m	5N.m
Socket size (A×B)	12×9mm	12×9mm	18×14mm	18×14mm	18×14mm
Arm length (L1)	261mm	343mm	420mm	521mm	891mm
Length	306mm	403mm	484mm	585mm	988mm
Weight	630g	1286g	1400g	1602g	5600g

OPTIONAL ACCESSORY

Interchangeable head	see details
----------------------	-------------



OPEN END HEAD (optional)



Ratchet head (optional)

Code	Square driver	Applicable wrenches
IST-6WM-R1	3/8"	IST-6WM60 IST-6WM100
IST-6WM-R2	1/2"	IST-6WM200 IST-6WM340
IST-6WM-R3	3/4"	IST-6WM600

BOX END HEAD (optional)

Code	Open size	Applicable wrenches	
IST-6WM-M7	7mm	IST-6WM60 IST-6WM100	
IST-6WM-M8	8mm		
IST-6WM-M10	10mm		
IST-6WM-M11	11mm		
IST-6WM-M12	12mm		
IST-6WM-M13	13mm		
IST-6WM-M14	14mm		
IST-6WM-M15	15mm		
IST-6WM-M16	16mm		
IST-6WM-M17	17mm		
IST-6WM-M18	18mm		
IST-6WM-M19	19mm		
IST-6WM-M21	21mm		
IST-6WM-M22	22mm		
IST-6WM-M13A	13mm		IST-6WM200 IST-6WM340 IST-6WM600
IST-6WM-M14A	14mm		
IST-6WM-M15A	15mm		
IST-6WM-M16A	16mm		
IST-6WM-M17A	17mm		
IST-6WM-M18A	18mm		
IST-6WM-M19A	19mm		
IST-6WM-M21A	21mm		

Code	Open size	Applicable wrenches	
IST-6WM-K7	7mm	IST-6WM60 IST-6WM100	
IST-6WM-K8	8mm		
IST-6WM-K9	9mm		
IST-6WM-K10	10mm		
IST-6WM-K11	11mm		
IST-6WM-K12	12mm		
IST-6WM-K13	13mm		
IST-6WM-K14	14mm		
IST-6WM-K15	15mm		
IST-6WM-K16	16mm		
IST-6WM-K17	17mm		
IST-6WM-K18	18mm		
IST-6WM-K19	19mm		
IST-6WM-K13A	13mm		IST-6WM200 IST-6WM340 IST-6WM600
IST-6WM-K14A	14mm		
IST-6WM-K15A	15mm		
IST-6WM-K16A	16mm		
IST-6WM-K17A	17mm		
IST-6WM-K18A	18mm		
IST-6WM-K19A	19mm		
IST-6WM-K21A	21mm		
IST-6WM-K22A	22mm		
IST-6WM-K24A	24mm		

ACCURACY $\pm 3\%$

ATTENTION: CLOCKWISE OPERATION ONLY

INSPECTION CERTIFICATE



INTERCHANGEABLE HEAD TORQUE WRENCH SETS

Set torque:



step 1: unlock



step 2: set



step 3: lock

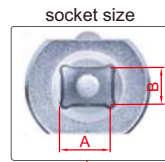

socket size

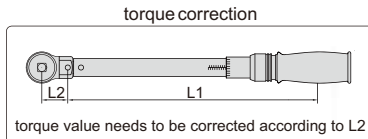

torque correction

torque value needs to be corrected according to L2



torque value
torque set lock ring

IST-8WM60



ratchet head (included)



box end head (included, only for IST-8WM10, IST-8WM20, IST-8WM60)



open end head (included)

- According to DIN ISO 6789, ASME B107.300-2010

SPECIFICATION

Code	IST-8WM10	IST-8WM20	IST-8WM60	IST-8WM100	IST-8WM200	IST-8WM340	IST-8WM400
Range (clockwise)	2~10N.m	4~20N.m	10~60N.m	20~100N.m	40~200N.m	60~340N.m	80~400N.m
Accuracy	$\pm 3\%$	$\pm 3\%$	$\pm 3\%$	$\pm 3\%$	$\pm 3\%$	$\pm 3\%$	$\pm 3\%$
Graduation	0.1N.m	0.1N.m	0.5N.m	0.5N.m	1N.m	2N.m	2N.m
Socket size (A×B)	12×9mm			18×14mm			
Arm length (L1)	218mm	261mm	261mm	366mm	420mm	521mm	521mm
Length	263mm	306mm	306mm	430mm	484mm	585mm	585mm
Weight	1264g	1372g	1372g	3712g	3825g	4047g	4047g

STANDARD DELIVERY

Code	IST-8WM10	IST-8WM20	IST-8WM60	IST-8WM100	IST-8WM200	IST-8WM340	IST-8WM400
Torque wrench	1pc	1pc	1pc	1pc	1pc	1pc	1pc
Ratchet head	1pc (1/4")	1pc (1/4")	1pc (3/8")	1pc (3/8")	1pc (1/2")	1pc (1/2")	1pc (1/2")
Box end head	3pcs (size 10, 13, 17mm)			—			
Open end head	3pcs (size 10, 13, 17mm)			9pcs (size 13, 14, 15, 17, 19, 22, 24, 27, 30mm)			

ACCURACY $\pm 4\%$

LOUD CLICK SOUND

INSPECTION CERTIFICATE

CLASSIC TORQUE WRENCHES



- Clockwise and counter-clockwise operation
- Unit: N.m, kgf.m, lbf.in, lbf.ft
- Loud click sound when target torque value is reached
- According to DIN ISO 6789, ASME B107.300-2010



square driver

IST-7WM135

SPECIFICATION

Code	IST-7WM33	IST-7WM68	IST-7WM135	IST-7WM225	IST-7WM330	IST-7WM560	IST-7WM800	IST-7WM1000
Range	5 ~ 33N.m	12 ~ 68N.m	25 ~ 135N.m	50 ~ 225N.m	70 ~ 330N.m	140 ~ 560N.m	200 ~ 800N.m	200 ~ 1000N.m
Accuracy	$\pm 4\%$	$\pm 4\%$	$\pm 4\%$	$\pm 4\%$	$\pm 4\%$	$\pm 4\%$	$\pm 4\%$	$\pm 4\%$
Graduation	1N.m	2N.m	5N.m	5N.m	10N.m	10N.m	20N.m	20N.m
Square driver (D)	1/4"	3/8"	1/2"	1/2"	1/2"	3/4"	3/4"	1"
Length	425mm	500mm	556mm	600mm	805mm	996mm	1070mm	1400mm
Weight	720g	1050g	1600g	2300g	2600g	7410g	7580g	12800g

DIAL TORQUE WRENCHES

INSPECTION CERTIFICATE

ACCURACY $\pm 4\%$



VIDEO

dial with metric and inch scales

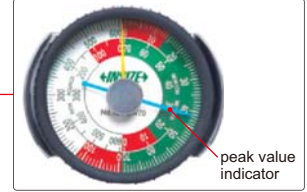

peak value indicator

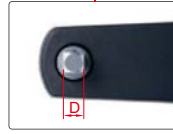

square driver



IST-DW70

- Clockwise and counter-clockwise operation
- According to DIN ISO 6789, ASME B107.300-2010

SPECIFICATION

Code	IST-DW3D5	IST-DW9	IST-DW18	IST-DW35	IST-DW70	IST-DW140	IST-DW240	IST-DW350
Range	0.7~3.5N.m 6~30in.lb	1.8~9N.m 15~75in.lb	3.6~18N.m 30~150in.lb	7~35N.m 60~300in.lb	14~70N.m 120~600in.lb	28~140N.m 20~100ft.lb	48~240N.m 35~175ft.lb	70~350N.m 50~250ft.lb
Accuracy	$\pm 4\%$	$\pm 4\%$	$\pm 4\%$	$\pm 4\%$	$\pm 4\%$	$\pm 4\%$	$\pm 4\%$	$\pm 4\%$
Graduation	0.05N.m 0.5in.lb	0.1N.m 1in.lb	0.2N.m 2in.lb	0.5N.m 5in.lb	1N.m 10in.lb	2N.m 1ft.lb	3N.m 2.5ft.lb	2.5N.m 2.5ft.lb
Square driver (D)	1/4"	1/4"	3/8"	3/8"	3/8"	1/2"	1/2"	1/2"
Length	254mm	254mm	254mm	254mm	378mm	546mm	546mm	546mm
Weight	480g	480g	480g	480g	820g	1300g	1300g	1300g

DIGITAL TORQUE ADAPTERS

INSPECTION CERTIFICATE

- Clockwise and counter-clockwise operation
- Set the desired torque first. After reaching the desired torque, set the angle and turn the wrench at this angle to apply extra torque
- Unit: N.m, in.lb, ft.lb, kg.cm, degree
- Peak and track working mode
- Target torque or angle value can be set, with audible and visible alarm:
 - Green LED light on and buzzer sounds when torque or angle value is 80%~100% of target torque or angle
 - Both green and red LED light on and buzzer sounds when target torque or angle value is reached
- Power off in 2 minutes automatically
- Memory 50 measurement values for browsing
- With overload record (once the torque reaches 110% of the maximum range)



IST-5W135A

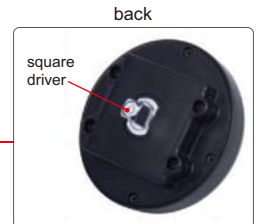

square driver

back

red alarm LED

square slot

buzzer

LCD display

green alarm LED

buttons

calibration port



VIDEO

SPECIFICATION

Code		IST-5W30A	IST-5W135A	IST-5W200A	IST-5W340A
Range	torque	6~30N.m	27~135N.m	40~200N.m	68~340N.m
	angle	0~999°			
Accuracy	clockwise	$\pm 3\%$			
	counter-clockwise	$\pm 4\%$			
	angle	$\pm 2^\circ$ (rotate 90°)			
Resolution	torque	0.01N.m	0.1N.m	0.1N.m	0.1N.m
	angle	1°			
Square driver (L)		1/4"	3/8"	1/2"	1/2"
Power supply		2xAAA batteries			
Length		Ø85×60mm	Ø85×75mm	Ø85×80mm	Ø85×80mm
Weight		150g	220g	240g	240g



working with mechanical wrenches

OPTIONAL ACCESSORY

Calibration cable	IST-SD-CABLE
-------------------	--------------

CODE	PAGE
11	
1103.....	1
1106.....	9
1108.....	2
1109.....	2
1110.....	3
1111.....	4
1114.....	1
1117.....	9
1118.....	1
1119.....	2
1120.....	15
1121.....	16
1122.....	20
1123.....	18
1124.....	15
1125.....	13
1130.....	3
1135.....	10
1136.....	9
1139.....	4
1141.....	24
1142.....	24
1143.....	24
1144.....	25
1145.....	28
1146.....	33
1147.....	24
1148.....	25
1149.....	23
1150.....	31
1154.....	32
1156.....	32
1161.....	21
1162.....	22
1163.....	128
1165.....	21
1166.....	179
1167.....	23
1168.....	23
1169.....	18
1170.....	4
1171.....	4
1172.....	22
1176.....	16
1177.....	19
1178.....	16
1179.....	21
1180.....	165
1181.....	22
1183.....	18
1185.....	17
1186.....	20
1187.....	17
1188.....	18
1189.....	20
1192.....	19
1193.....	3
12	

CODE	PAGE
1201.....	5
1202.....	6
1203.....	5
1204.....	5
1205.....	6
1207.....	10
1208.....	11
1210.....	11
1214.....	11
1215.....	12
1217.....	7
1223.....	7
1224.....	8
1233.....	6
1236.....	10
1238.....	7
1240.....	26
1244.....	27
1247.....	26
1248.....	27
1249.....	26
1250.....	33
1253.....	33
1267.....	166
1275.....	177
13	
1311.....	5
1312.....	5
1351.....	32
15	
1520.....	17
1524.....	20
1525.....	19
1526.....	14
21	
2103.....	90
2104.....	90
2108.....	91
2109.....	92
2112.....	89
2113.....	90
2114.....	88
2115.....	91
2116.....	89
2117.....	93
2118.....	92
2122.....	81
2124.....	62
2132.....	121
2141.....	29
2142.....	28
2151.....	120
2152.....	81
2163.....	128
2164.....	129
2166.....	128
2167.....	128
2168.....	129

CODE	PAGE
2170.....	256
2171.....	151
2172.....	153
2174.....	151
2175.....	255
2176.....	151
2179.....	255
2183.....	86
2184.....	127
2186.....	126
2187.....	127
22	
2222.....	120
2275.....	157
2276.....	178
2278.....	178
23	
2301.....	97
2302.....	100
2308.....	98
2309.....	101
2310.....	100
2311.....	97
2313.....	97
2314.....	98
2316.....	101
2318.....	100
2321.....	120
2322.....	81
2324.....	99
2328.....	99
2332.....	121
2333.....	121
2341.....	30
2342.....	29
2343.....	28
2344.....	246
2357.....	99
2361.....	124
2363.....	124
2364.....	122
2365.....	123
2366.....	122
2367.....	124
2372.....	153
2373.....	153
2374.....	152
2380.....	107
2381.....	107
2383.....	108
2385.....	195
2386.....	108
2391.....	109
2394.....	198
2395.....	83
2396.....	110
2397.....	198
2398.....	107
2399.....	108

CODE	PAGE
24	
2421.....	74
2422.....	77
2423.....	77
2424.....	79
2425.....	76
2426.....	73
2427.....	75
2428.....	78
2429.....	76
2430.....	87
2431.....	78
2432.....	79
2433.....	80
2491.....	72
28	
2801.....	98
2824.....	82
2827.....	82
2828.....	82
2830.....	94
2841.....	129
2842.....	195
2843.....	245
2844.....	245
2852.....	81
2862.....	125
2863.....	125
2866.....	125
2871.....	122
2872.....	122
2873.....	123
2874.....	130
2875.....	123
2876.....	124
2880.....	105
2881.....	93
2882.....	96
2885.....	96
2886.....	94
2887.....	94
2888.....	95
2889.....	96
2890.....	93
2891.....	94
2892.....	95
2893.....	95
2894.....	95
2895.....	106
2896.....	106
2897.....	105
2898.....	107
2899.....	106
29	
2921.....	79
2941.....	85
2942.....	85
2943.....	166

CODE NO. INDEX

CODE	PAGE
2944.....	166
31	
3101.....	35
3108.....	35
3109.....	35
3127.....	64
3128.....	65
32	
3202.....	38
3203.....	37
3205.....	40
3206.....	39
3208.....	36
3209.....	38
3210.....	36
3220.....	65
3221.....	67
3222.....	68
3224.....	68
3225.....	68
3226.....	70
3227.....	63
3228.....	65
3229.....	67
3230.....	47
3232.....	48
3233.....	49
3235.....	41
3236.....	38
3238.....	55
3239.....	52
3240.....	30
3241.....	31
3260.....	51
3261.....	50
3262.....	53
3263.....	56
3266.....	49
3280.....	54
3281.....	45
3282.....	55
3285.....	56
3287.....	42
3288.....	51
3290.....	53
3291.....	46
3292.....	56
3293.....	56
3294.....	55
3296.....	42
33	
3331.....	41
3332.....	40
3333.....	41
3334.....	127
3335.....	126
3336.....	126
3337.....	125

CODE	PAGE
34	
3400.....	36
35	
3506.....	39
3520.....	66
3530.....	48
3532.....	48
3533.....	50
3539.....	52
3540.....	30
3560.....	51
3561.....	50
3562.....	53
3566.....	49
3580.....	54
3581.....	45
3588.....	52
3590.....	54
3591.....	47
3594.....	55
36	
3631.....	34
3632.....	34
3633.....	42
3634.....	69
3635.....	69
3636.....	46
3637.....	66
3638.....	70
3639.....	43
3640.....	66
3641.....	70
40	
4001.....	138
4002.....	140
4003.....	191
4004.....	191
41	
4100.....	133
4101.....	134
4105.....	131
4106.....	132
4107.....	136
4108.....	136
4109.....	140
4110.....	142
4111.....	135
4118.....	142
4120.....	145
4121.....	147
4124.....	144
4129.....	146
4130.....	144
4131.....	146
4139.....	145
4141.....	154

CODE	PAGE
4142.....	155
4143.....	191
4144.....	154
4147.....	159
4155.....	192
4157.....	119
4164.....	135
4166.....	141
4180.....	160
4184.....	57
42	
4206.....	85
4208.....	85
4209.....	86
46	
4601.....	161
4602.....	161
4605.....	161
4621.....	162
4622.....	162
4630.....	166
4631.....	148
4632.....	148
4633.....	149
4634.....	149
4635.....	150
4636.....	150
4641.....	147
4642.....	147
4643.....	149
4644.....	149
4645.....	150
4646.....	150
4653.....	71
4655.....	72
47	
4700.....	159
4701.....	157
4702.....	159
4706.....	158
4707.....	157
4710.....	154
4720.....	118
4721.....	117
4722.....	118
4723.....	118
4724.....	117
4725.....	116
4726.....	116
4745.....	157
4747.....	158
4754.....	159
4760.....	158
4762.....	158
4770.....	154
4780.....	151
4781.....	152
4782.....	119

CODE	PAGE
4783.....	117
4788.....	119
4789.....	116
4790.....	155
4791.....	156
4792.....	156
4793.....	156
4794.....	155
4795.....	156
4797.....	152
4799.....	152
48	
4801.....	164
4802.....	165
4804.....	165
4806.....	164
4807.....	164
4808.....	173
4809.....	173
4810.....	163
4812.....	164
4820.....	163
4824.....	162
4830.....	167
4831.....	168
4832.....	168
4833.....	167
4834.....	171
4835.....	170
4836.....	168
4837.....	167
4838.....	169
4839.....	172
4840.....	172
4841.....	172
4842.....	173
4843.....	173
4844.....	165
4845.....	246
4846.....	170
4847.....	168
4848.....	171
4850.....	170
4851.....	171
49	
4902.....	256
4903.....	257
4905.....	257
4906.....	256
4907.....	257
4908.....	257
4910.....	258
4911.....	258
4912.....	258
4913.....	258
4914.....	259
50	
5013.....	183

CODE	PAGE
5021.....	180
5022.....	180
5023.....	180
5024.....	180
5031.....	181
5041.....	181
5042.....	181
5051.....	181
5052.....	182
5061.....	182
5062.....	182
5063.....	183
5091.....	183
61	
6140.....	8
6141.....	27
6143.....	17
6144.....	8
62	
6200.....	111
6201.....	111
6202.....	111
6207.....	113
6208.....	112
6210.....	111
6211.....	113
6214.....	113
6215.....	112
6217.....	112
6224.....	113
6272.....	112
6282.....	102~103
6284.....	109
6289.....	104
6291.....	110
6293.....	110
6294.....	196
6295.....	195
6296.....	109
6297.....	109
6298.....	109
63	
6300.....	58
6301.....	57
6310.....	58
6312.....	84
6315.....	57
6353.....	58
6354.....	58
6372.....	59
6373.....	59
6375.....	61
6377.....	61
6381.....	60
6384.....	59
6385.....	59
6386.....	60
6387.....	60

CODE	PAGE
6388.....	61
65	
6521.....	194
6522.....	193
6523.....	193
6524.....	194
6525.....	194
6526.....	194
6527.....	193
6533.....	190
6534.....	190
6535.....	191
6547.....	192
6548.....	192
6549.....	192
6550.....	197
6553.....	198
6554.....	198
6562.....	197
6566.....	196
6567.....	197
6568.....	197
6571.....	196
68	
6801.....	189
6802.....	186
6803.....	186
6804.....	186
6832.....	169
6862.....	115
6863.....	114
6864.....	115
6865.....	115
6866.....	114
6867.....	114
6881.....	137
6882.....	139
6883.....	136
6884.....	139
6886.....	136
6887.....	187
6888.....	187
6889.....	188
6890.....	188
6891.....	189
6892.....	189
6894.....	190
6896.....	185
6897.....	187
6898.....	185
6899.....	190
69	
6900.....	184
6902.....	184
6903.....	185
6990.....	179
71	

CODE	PAGE
7101.....	201
7102.....	202
7106.....	204
7107.....	204
7108.....	205
7110.....	177
7111.....	177
7113.....	176
7114.....	87
7115.....	87
7116.....	88
7117.....	160
7118.....	160
7119.....	176
7120.....	177
7121.....	176
7122.....	176
7124.....	175
7125.....	88
7140.....	175
7150.....	34
72	
7202.....	179
7203.....	179
7205.....	178
7230.....	179
7231.....	179
7232.....	179
7240.....	174
7241.....	174
7247.....	175
7260.....	175
7261.....	174
7262.....	174
73	
7302.....	200
7304.....	200
7305.....	201
7306.....	200
7311.....	199
7321.....	71
7330.....	104~105
7331.....	104
7332.....	104
7340.....	142
7341.....	143
7350.....	83
7351.....	83
7352.....	80
7381.....	45
7382.....	43
7383.....	46
7384.....	44
7385.....	44
7391.....	47
75	
7511.....	225
7512.....	226

CODE	PAGE
7513.....	226
7514.....	225
7515.....	225
91	
9110.....	249
92	
9221.....	251
9222.....	251
93	
9331.....	250
9341.....	250
9351.....	251
95	
9561.....	249
96	
9631.....	267
ISD	
ISD-A100.....	215
ISD-V150.....	216
ISD-V250.....	216
ISD-V300.....	216
ISE	
ISE-2DT.....	255
ISE-L050.....	254
ISE-L051.....	254
ISF	
ISF-1DFxxx.....	282
ISF-DFxxx.....	282
ISF-Fxxx.....	283
ISF-MT1K.....	283
ISF-MT500.....	283
ISF-TGxxx.....	283
ISH	
ISH-BRV.....	264
ISH-DSA.....	279
ISH-DSD.....	279
ISH-DS-STAND.....	280
ISH-DV10.....	267
ISH-DV50.....	267
ISH-MR150.....	263
ISH-MRD200.....	262
ISH-OS2.....	281
ISH-PHB.....	274
ISH-PH-SP9.....	275
ISH-R150.....	264
ISH-RD200.....	263
ISH-RSR400.....	259
ISH-RSR500.....	260
ISH-RSR600.....	261
ISH-S30A.....	280
ISH-S30A-BLOCK.....	280
ISH-S30D.....	280

CODE NO. INDEX

CODE	PAGE
ISH-S30D-BLOCK.....	280
ISH-SAM.....	281
ISH-SDM.....	281
ISH-SPHA.....	272
ISH-SPHD.....	274
ISH-STAC.....	281
ISH-STD.....	281
ISHB	
ISHB-B300.....	278
ISHB-C161.....	278
ISHB-D200.....	265
ISHB-D300.....	265
ISHB-H131.....	278
ISHB-M100.....	265
ISHB-P101.....	277
ISHB-TSA.....	266
ISHB-TSB.....	266
ISHL	
ISHL-P100.....	273
ISHL-P200.....	273
ISHR	
ISHR-B141.....	276
ISHR-D121.....	275
ISHR-M111.....	276
ISHR-P151.....	277
ISHU	
ISHU-330.....	270
ISHU-340.....	271
ISHU-460.....	268
ISHU-470.....	269~270
ISHV	
ISHV-D120.....	266
ISHW	
ISHW-B70.....	279
ISHW-B75.....	279
ISHW-B92.....	279
ISHW-L20.....	279
ISHW-L20A.....	279

CODE	PAGE
ISHW-L20B.....	279
ISL	
ISL-A1xxx.....	203
ISL-A5xxx.....	203
ISL-B5xxx.....	203
ISL-DR2.....	202
ISL-DR3.....	202
ISM	
ISM-D500.....	224
ISM-DM40.....	217
ISM-M1000.....	224
ISM-M2000.....	222
ISM-M600.....	223
ISM-PM160LA.....	218
ISM-PM200SB.....	218
ISM-PM600SB.....	218
ISM-PMxxx.....	225
ISM-TV200.....	220
ISM-TV200W.....	220
ISM-WF200.....	219~220
ISM-ZS30.....	223
ISM-ZS50.....	222
ISM-ZS50T.....	222
ISM-ZS60.....	221
ISN	
ISN-L70.....	248
ISO	
ISO-1000F.....	244
ISO-1500F.....	243
ISO-2000FN.....	241
ISO-3000FN.....	242
ISO-5000F.....	242
ISO-5000FN.....	243
ISP	
ISP-A1000E.....	207~208
ISP-A3000E.....	211~212
ISP-A5000E.....	209~210
ISP-A7000E.....	213~214
ISP-AZ3020.....	209~210

CODE	PAGE
ISP-TP300.....	205
ISP-W3020.....	211~212
ISP-W4025.....	213~214
ISP-Z3015.....	207~208
ISQ	
ISQ-DG6.....	252
ISQ-DG8.....	252
ISQ-PF200.....	245
ISQ-PGS200.....	206
ISQ-PK100.....	244
ISQ-RA600.....	86
ISQ-RM30.....	252
ISQ-TE100.....	253
ISQ-TS120K.....	248
ISR	
ISR-C002.....	238
ISR-C003.....	239
ISR-C100.....	237
ISR-CS017.....	241
ISR-CS018.....	241
ISR-CS130.....	240
ISR-CS2.....	240
ISR-CSxxx.....	239
ISR-RSxxx.....	240
ISR-S1000B.....	233~234
ISR-S400.....	235~236
IST	
IST-1Wxxx.....	288
IST-2WMxxx.....	290
IST-2Wxxx.....	289
IST-3Wxxx.....	287
IST-4Wxxx.....	290
IST-5Wxxx.....	293
IST-6WMxxx.....	291
IST-7WMxxx.....	292
IST-8WMxxx.....	292
IST-DCTxxx.....	285
IST-DWxxx.....	293
IST-MH1D2.....	285
IST-MHxxx.....	286
IST-MS1D2.....	285

CODE	PAGE
IST-MSxxx.....	286
IST-SD200.....	285
IST-SD400.....	285
IST-SD50.....	285
IST-TS500.....	284
IST-TTxxx.....	284
IST-WP12.....	286
IST-WP20.....	286
IST-WP6.....	286
IST-WSxxx.....	287
IST-Wxxx.....	288
ISU	
ISU-100D.....	247
ISU-250C.....	247
ISU-300D.....	246
ISV	
ISV-1CAM.....	230
ISV-1HLED.....	230
ISV-1Hxxx.....	229
ISV-1LED1.....	230
ISV-2000D.....	227
ISV-2001D.....	227
ISV-2002D.....	227
ISV-3000D.....	227
ISV-3001D.....	227
ISV-3002D.....	227
ISV-4000D.....	226
ISV-4001D.....	226
ISV-5000D.....	226
ISV-5001D.....	226
ISV-E10.....	228
ISV-E20.....	228
ISV-HCAM.....	232
ISV-HF4030.....	230
ISV-HL3000.....	232
ISV-HMxxx.....	231
ISV-HP1911.....	231
ISV-HP2811.....	231
ISV-HP2817.....	231
ISV-HR6032.....	232
ISV-RV.....	227
ISV-VP280.....	229

No. Application	Page
1. Shaft Diameter.....	298
2. External Groove Diameter.....	298~299
3. Arc Radius.....	299
4. Bore Diameter.....	299
5. Diameter Of Groove Inside Hole.....	299
6. Width And Position Of Groove Inside Hole.....	299~300
7. Diameter Of Bore With Chamfer.....	300
8. Chamfer.....	300
9. Tube Wall Thickness.....	300
10. Height.....	300
11. Depth.....	300
12. Thickness.....	300
13. Slot Width.....	300~301
14. Hole Center-to-center And Center-to-Edge Distance.....	301
15. Angle.....	301
16. Straightness And Flatness.....	301
17. Squareness.....	301
18. Coaxiality And Runout.....	301
19. Gear And Spline.....	301~302
20. Thread.....	302
21. Micrometer Calibration.....	302
22. Caliper Calibration.....	302
23. Data Output And Software.....	302
24. Welding.....	302
25. Drill Bits.....	302
26. Taps, Reamers And End Mills.....	303
27. Jewelleries.....	303

28. Crankshaft Deflection.....	303
29. Saw Teeth Setting.....	303
30. Car Brake.....	303
31. Cable Crimp Height.....	303
32. Wire Diameter.....	303
33. RTJ Ring Groove Diameter.....	303
34. Wire Rope Diameter, Rubber And Sponge Thickness.....	303
35. Can Seam.....	303
36. Mark And Scribe.....	303
37. Workpiece Clamping And Set Up.....	304
38. Tooling Set Up.....	304
39. Scale.....	304
40. Contour.....	304
41. Vision Measurement.....	304
42. Vision Inspection.....	304~305
43. Videoscope And Borescope.....	305
44. Thickness Measurement From One Side.....	305
45. Coating And Painting.....	305
46. Distance.....	305
47. Roughness.....	305
48. Level.....	305
49. Pull And Push Force.....	305
50. Hardness.....	306
51. Torque.....	306
52. Rotary Speed.....	306
53. Gloss.....	306
54. Concentration.....	306
55. Temperature.....	306

1

SHAFT DIAMETER



Dial Snap Gages

2186-
(page 126)



Adjustable Snap Gages

2187-
(page 127)



Indicating Micrometers

3333-, 3332-
(page 40-41)



Micrometers With Dial Indicator

3296-, 3331-, 3633-
(page 41-42)



Dial Snap Gages

3337-, 3336-, 2184-
(page 125-127)



Dial Snap Gages

3335-, 3334-
(page 126-127)



Outside Micrometers

(page 34-40)



Universal Calipers

1125-
(page 13)



Digital/Dial/Vernier Calipers (PAGE 1-12)



Circumference Tapes

7114-, 7116-, 7115-
(PAGE 87-88)



2

EXTERNAL GROOVE DIAMETER



Digital Blade Calipers

1188-
(page 18)

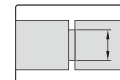

Blade Micrometers

3232-, 3532-
(page 48)

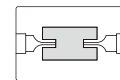

Digital Outside Neck Calipers

1187-
(page 17)

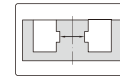

Digital Calipers With Interchangeable Points

1526-, 1124-
(page 14-15)

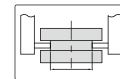

Universal Calipers

1125-
(page 13)

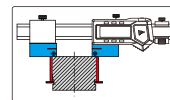

External Caliper Gages

2333-, 2332-, 2132-
(page 121)



APPLICATION INDEX

Outside Calipers
7262-, 7241-
(PAGE 174)



3

ARC RADIUS

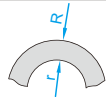

Large Diameter Gage
ISQ-RA600
(page 86)



Digital Radius Gage
2183
(page 86)



Digital Arc Radius Calipers
1189-
(page 20)



Radius Gages
4801-, 4804-
(page 164-165)



4

BORE DIAMETER



Digital/Dial/Vernier Calipers With Internal Measuring Jaws
(page 1-12)



Universal Calipers
1125-
(page 13)



Digital Inside Knife-edge Calipers
1123-
(page 18)



Inside Micrometers
3220-, 3520-
(page 65-66)



Three Points Internal Micrometers
3227-, 3127-, 3228-, 3128-
(page 63-65)



Pistol Grip Three Points Bore Gages
2124-
(page 62)



Tubular Inside Micrometers
(page 67-69)



Bore Plug Gages
4653-
(page 71)



Split Type Dial Bore Gages
(page 72-76)



Bore Gages
(page 76-83)



Telescoping Gages
4208-, 4206-, 4209-
(page 85-86)



Inside Spring Calipers
7261-, 7240-
(page 174)



Internal Caliper Gages
2222-, 2321-, 2151-
(page 120)



Pin Gages
4166-, 4110-, 4118- (page 141-142)



Plain Plug Gages
4124-
(page 144)



Taper Gages
4833-, 4837-
(page 167)



Tape Bore Gages
2430-
(page 87)



Internal Circumference Tapes
7125-
(page 88)



5

DIAMETER OF GROOVE INSIDE HOLE

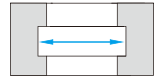

Universal Calipers
1125-
(page 13)



Digital Calipers With Interchangeable Points
1526-, 1124-
(page 14-15)



Digital Inside Groove Calipers
1120-, 1121-, 1176-, 1178-, 1520-
(page 15-17)



Accessory Sets For Digital Calipers
6144-
(page 8)

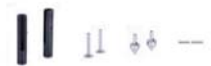

Internal Caliper Gages
2222-, 2321-, 2151-
(page 120)

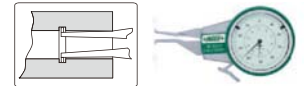

Internal Groove Bore Gages
2433-
(page 80)



6

WIDTH AND POSITION OF GROOVE INSIDE HOLE

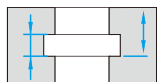

Digital Hook Calipers
1122-
(page 20)



Depth Gages With Hook
1142-, 1144- (page 24-25)
1248- (page 27)

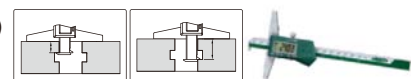

Digital Depth Gages With Round Depth Bar
1148- (page 25)

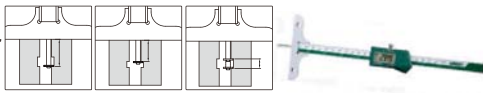

Groove Micrometers
3287-
(page 42)

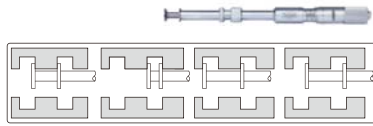

7 DIAMETER OF BORE WITH CHAMFER



Internal Chamfer Gages
2941-, 2942-
(page 85)

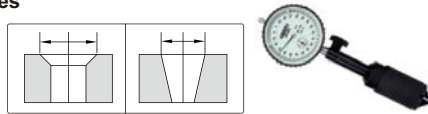

8 CHAMFER



Chamfer Gages
4844-, 1180-, 1267-
(page 165-166)



Chamfer Height Gages
2943-, 2944-
(page 166)



9 TUBE WALL THICKNESS

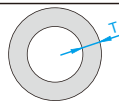

Digital Tube Thickness Calipers
1161-
(page 21)



Cylindrical Anvil Tube Micrometers
3261-, 3561-
(page 50)



Spherical Anvil Tube Micrometers
3260-, 3560-
(page 51)



Tube Thickness Gages
2876-, 2367-
(page 124)

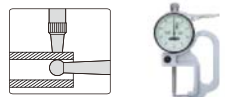

Digital Tube Thickness Gages
2873-
(page 123)

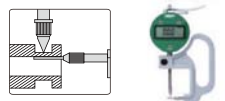

10 HEIGHT

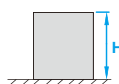

Height Gages
(page 31-33)



Dial Indicator Stands
6866-, 6867-, 6863-, 6864-, 6862-
(page 114-115)



Transfer Stand
6865-
(page 115)



11 DEPTH

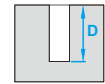

Depth Gages
1149-, 1141-, 1147- (page 23-24)
1240-, 1247-, 1249- (page 26)



Depth Gages With Point
1143-
(page 24)



Depth Gages With Hook
1142-, 1144- (page 24-25)
1248- (page 27)

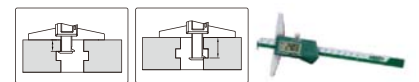

Digital Depth Gages With Round Depth Bar
1148- (page 25)

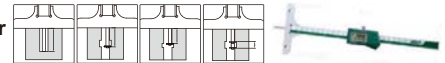

Mini Depth Gages
1244-, 1145-
(page 27-28)



Dial/Digital Depth Gages
2343-, 2142-, 2341-, 2342-, 2141-
(page 28-30)



Depth Micrometers
3540-, 3240-, 3241-
(page 30-31)



Digital/Dial/Vernier Calipers With Depth Bar
(page 1-7)



12 THICKNESS



Thickness Gages
(page 122-125)



Digital Snap Gages
2166-, 2167-, 2163-, 1163-
(page 128)



External Caliper Gages
2333-, 2332-, 2132-
(page 121)



13 SLOT WIDTH

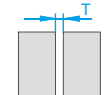

Taper Gages
4630-, 4833-, 4837-
(page 166-167)



Internal Caliper Gages
2222-, 2321-, 2151-
(page 120)



APPLICATION INDEX

Feeler Gages

4601-, 4602-, 4605-
(page 161)



Step And Gap Gage

2168-
(page 129)

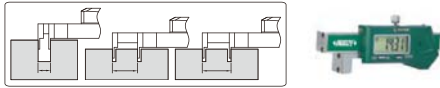

Groove Micrometers

3287-
(page 42)

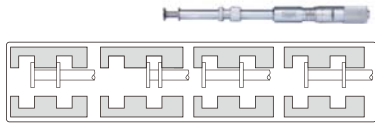

14 HOLE CENTER-TO-CENTER AND CENTER-TO-EDGE DISTANCE

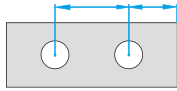

Digital Centering Calipers

1192-, 1177-, 1525-,
1524- (page 19-20)



Universal Calipers

1125-
(page 13)



Accessory Sets For Digital Calipers

6144-
(page 8)



15 ANGLE

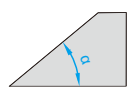

Protractors

(page 151-152)



Protractors

2374-, 2372-, 2373-, 2172-
(page 152-153)



Combination Square Sets

2278-
(page 178)



Squares

4745-, 4747-, 4760-, 4762-, 4706-, 4754-
(page 157-159)



Angle Gages

4806-, 4807
(page 164)



Angle Gage Blocks

4109-, 4002-
(page 140)



Digital Levels And Protractors

2175-, 2179-, 2170-
(page 255-256)

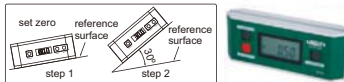

16 STRAIGHTNESS AND FLATNESS

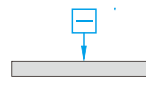

Straight Edges

4700-, 4147-, 4180-, 7117-, 7118-
(page 159-160)



Electronic Levels

ISE-L050, ISE-L051
(page 254)



17 SQUARENESS

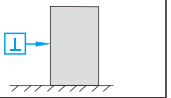

Squares

4141-, 4144-, 4710-
(page 154)



Granite Squares With V Groove

4142-
(page 155)



Perpendicularity Testers

4770-
(page 154)



Squares

(page 155-157)



18 COAXIALITY AND RUNOUT

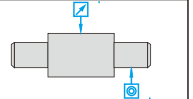

Concentricity Gages

(page 116-117)



Bench Centers

(page 117-119)



Sine Bench Centers

4157-
(page 119)

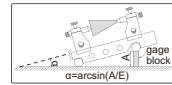

V-blocks

(page 185-187)



Magnetic V-blocks

(page 188-190)



19 GEAR AND SPLINE

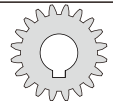

Digital Gear Tooth Calipers

1181-
(page 22)

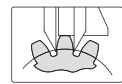

Disk Micrometers

3282-, 3294-, 3594-
(page 55)

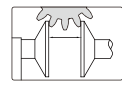

External Gear Tooth Micrometers

3636-, 3291-, 3591-
(page 46-47)

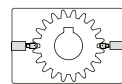

Internal Gear Tooth Micrometers

3637-
(page 66)

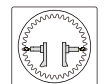

Internal Gear Tooth Micrometers

3638-
(page 70)

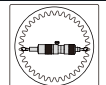

Gear Bore Gages

2428-
(page 78)



Internal Spline Plug Gages
4655-
(page 72)



Universal Calipers
1125-
(page 13)

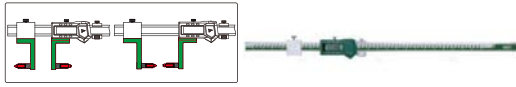

Digital Calipers With Interchangeable Points
1526-, 1124-
(page 14-15)



20 THREAD



3-wires
7382-
(page 43)

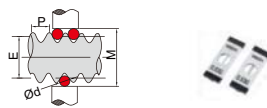

External Screw Thread Micrometers
3639- (page 43)
3281-, 3581- (page 45)

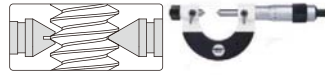

Internal Screw Thread Micrometers
3640- (page 66)



Internal Screw Thread Micrometers
3641-, 3226- (page 70)



Thread Plug Gages
(page 144-150)



Thread Ring Gages
(page 145-150)



Pitch Gages
4824-, 4820-
(page 162-163)



External Thread Measuring Devices
ISQ-TE100
(page 253)



Universal Calipers
1125-
(page 13)



Digital Calipers With Interchangeable Points
1526-, 1124-
(page 14-15)

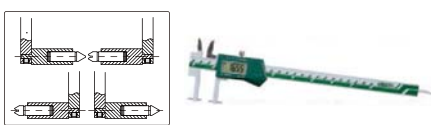

21 MICROMETER CALIBRATION

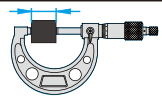

Micrometer Measuring Force Detectors
6315
(page 57)



Optical Parallels
4184-
(page 57)



Micrometer Inspection Gage Block Sets
4107-
(page 136)



22 CALIPER CALIBRATION

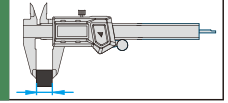

Caliper Inspection Gage Block Sets
4108-
(page 136)



Caliper/Height Gage Checkers
6884-
(page 139)



Check Masters
6882-
(page 139)



23 DATA OUTPUT AND SOFTWARE

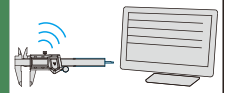

Measuring Data Management Software
7311- (page 199)



Wireless Data Transfer System
7306- (page 200)



Data Output Cables
7302-, 7305- (page 200-201)



24 WELDING



Welding Gages
(page 167-172)



Pipe Welding Gages
4841-, 4839-
(page 172)



25 DRILL BITS



Drill Point Gages
4843-
(page 173)

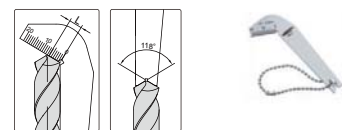

Drill Angle Gages
4842-
(page 173)

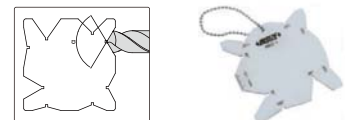

APPLICATION INDEX

26

TAPS, REAMERS AND END MILLS

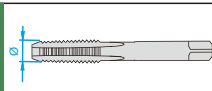

V-anvil Micrometers
3290-, 3590-
(page 53-54)



27

JEWELLERIES



Thickness Gages
2361-
(page 124)

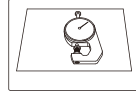

Lie-down use for small articles on the table



Digital Snap Gages
2167-
(page 128)



Digital 3-purpose Snap Gages
2164-
(page 129)



28

CRANKSHAFT DEFLECTION

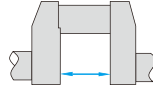

Crankshaft Testers
2841-
(page 129)

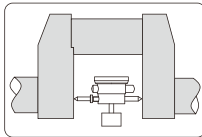

29

SAW TEETH SETTING

Saw Teeth Setting Gages
2874-
(page 130)



30

CAR BRAKE



Digital Disk Brake Calipers
1162-, 1167-
(page 22-23)



Digital Drum Brake Calipers
1168-
(page 23)

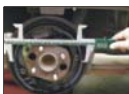

Disc Brake Micrometers
3288-, 3588-
(page 51-52)



31

CABLE CRIMP HEIGHT

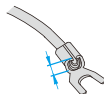

Digital Crimp Height Calipers
1165-
(page 21)



Crimp Height Micrometers
3266-, 3566-
(page 49)



32

WIRE DIAMETER

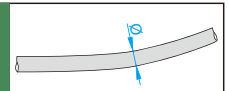

Wire Micrometers
3285-
(page 56)

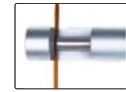

33

RTJ RING GROOVE DIAMETER

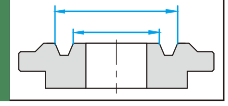

Digital RTJ Ring Groove Calipers
1179-
(page 21)

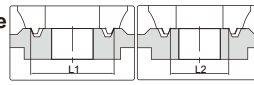

34

WIRE ROPE DIAMETER, RUBBER AND SPONGE THICKNESS

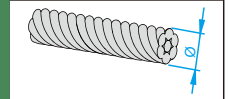

Digital Calipers With Large Measuring Faces
1172-
(page 22)

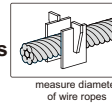

measure diameter of wire ropes

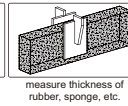

measure thickness of rubber, sponge, etc.



35

CAN SEAM

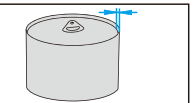

Can Seam Micrometers
3293-
(page 56)

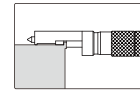

36

MARK AND SCRIBE

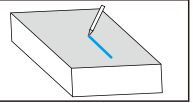

Combination Squares
2278-, 2276-
(page 178)



Marking Gages
7120-, 1275-
(page 177)

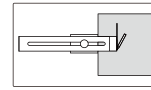

Center Marking Gages
7205-
(page 178)

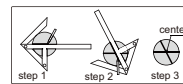

step 1

step 2

center step 3



Scribing Calipers
7202-, 1166-, 7203-
(page 179)

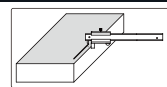

Height Scribers
6990-
(page 179)



Scribers
7230, 7231, 7232 (page 179)



Dividers
7260-, 7247-
(page 175)



37 WORKPIECE CLAMPING AND SET UP

Magnetic Rectangular Blocks
6898-
(page 185)



V-blocks
(page 185-187)



Magnetic V-blocks
(page 188-190)



Parallels
6533-, 6534-, 6894-, 4143-
(page 190-191)



Angle Plates
4003-, 4004-, 6535-
(page 191)



Right Angle Plates
6547-, 6548-, 6549-
(page 192)



Sine Bar And Vises
4155-, 6527-, 6522-, 6523-, 6524-
(page 192-194)



Precision Universal Vises
6521-
(page 194)



Precision Vises
6525-, 6526-
(page 194)



38 TOOLING SET UP

Centering Indicators
2385-
(page 195)

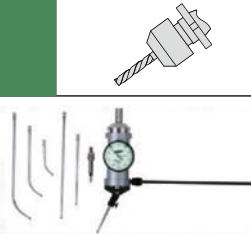

Indicator Centering Holders
6291- (page 110)
6295- (page 195)
6294- (page 196)



3D Testers
2842-
(page 195)



Edge Finders
(page 196-197)



Zero Setters
(page 197-198)



Tool Presetter
ISP-TP300
(page 205)



39 SCALE



Digital Scales
7101-, 7102-
(page 201-202)



Linear Scales
ISL-A1-xxx/A5-xxx/B5-xxx
(page 203)



40 CONTOUR

Contour Measuring Machine
ISQ-PGS200
(page 206)



41 VISION MEASUREMENT

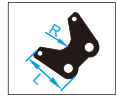

Profile Projectors
(page 207-214)



Vision Measuring Systems
ISD-V150/V250/V300, ISD-A100
(page 215-216)



Digital Measuring Microscopes
(page 218-220)



Digital Measuring Microscope
ISM-DM40
(page 217)



Digital Zoom Microscopes
ISM-ZS60
(page 221)



Portable Measuring Microscopes
ISM-PM20/40/50/100
(page 225)



42 VISION INSPECTION

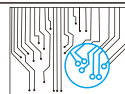

Digital Microscopes
(page 218-220)



Digital Measuring Microscope
ISM-DM40
(page 217)



APPLICATION INDEX

Digital Zoom Microscopes
ISM-ZS60
(page 221)



Stereo Microscopes
ISM-ZS50/ZS50T/ZS30
(page 222-223)



High Magnification Microscopes
ISM-M600/M1000 (page 223-224)
ISM-M2000 (page 222)



Magnifiers
7511-, 7515-, 7514-,
7513-, 7512-
(page 225-226)



43 VIDEOSCOPE AND BORESCOPE



Videoscopes
(page 226-228)



Pipe Videoscopes
ISV-VP280
(page 229)



Borescopes
(page 229-232)



44 THICKNESS MEASUREMENT FROM ONE SIDE

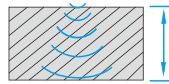

Ultrasonic Thickness Gages (Through Coating)
ISU-300D (page 246)

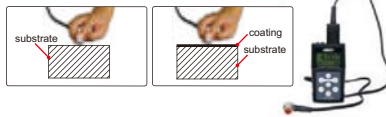

Ultrasonic Thickness Gages
ISU-250C, ISU-100D
(page 247)



45 COATING AND PAINTING

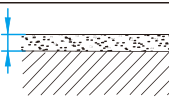

Coating Thickness Gages
(page 241-243)



Wet Film Gages
4845-
(page 246)



Surface Profile Gages
2344-, 2843-, 2844-
(page 245-246)



Cross Cut Adhesion Tester
ISQ-PK100
(page 244)



Pull Off Adhesion Tester
ISQ-PF200
(PAGE 245)



46 DISTANCE

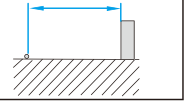

Laser Distance Meters
ISN-L70
(page 248)
9561-
(page 249)



47 ROUGHNESS

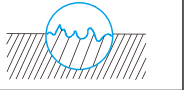

Roughness Testers
(page 233-239)



Roughness Specimens
(page 239-241)



48 LEVEL

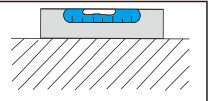

Electronic Levels
ISE-L051, ISE-L050
(page 254)



Digital Level
ISE-2DT
(page 255)



Digital Levels And Protractors
2175-, 2179-, 2170-
(page 255-256)



Levels
4906-, 4905-, 4907-, 4908-, 4902-
(page 256-257)



Aluminum Alloy Levels
4911-
(page 258)



Aluminum Levels
4912-, 4914-, 4913-
(page 258-259)



Digital Levels
4910-
(page 258)



49 PULL AND PUSH FORCE

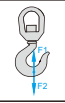

Force Gages
(page 282-283)



Dial Tension Gages
ISF-TGxx
(page 283)



50 HARDNESS

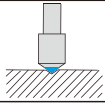

Rockwell (Desk Model)
(page 259-264)



Brinell (Desk Model)
ISHB-M100/D200/D300
(page 265)



Micro-Vickers (Desk Model)
ISHV-D120
(page 266)



Vickers (Desk Model)
ISH-DV10/DV50
(page 267)



Brinell/Rockwell/Rickers (Desk Model)
ISH-BRV
(page 264)



Rockwell (Portable)
ISHR-P151
(page 277)



Rockwell (Portable)
ISHR-D121/M111
(page 275-276)



Brinell/Rockwell (Portable)
ISHR-B141
(page 276)



Brinell (Portable)
ISHB-H131/P101/C161
(Page 277-278)



Leeb (Portable)
ISH-SPHA/PHB/SPHD, ISHL-P100/P200
(page 272-274)



Ultrasonic (Portable)
ISHU-460 (page 268)
ISHU-330 (page 270)



Ultrasonic/Leeb (Portable)
ISHU-470 (page 269)
ISHU-340 (page 271)



Webster (Portable)
ISHW-L20/L20A/L20B/B70/B75/B92
(page 279)



Barcol (Portable)
ISHB-B300
(page 278)



Shore (Portable)
ISH-DSA/DSD, ISH-S30A/S30D, ISH-SAM/SDM
(page 279-281)



51 TORQUE

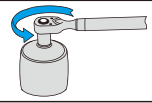

Digital Torque Testers
IST-TTxxx
(page 284)



Digital Bottle Cap Torque Testers
IST-DCTxxx
(page 285)



Torque Screwdrivers
IST-SDxxx, IST-Mxxxx
(page 285-286)



Torque Wrenches
(page 286-293)



52 ROTARY SPEED

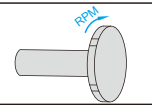

Digital LED Tachometer/Stroboscope
ISQ-TS120K
(page 248)



Digital Tachometers
9221-, 9222-
(page 251)



53 GLOSS

Gloss Meters
ISQ-DG8, ISQ-DG6
(page 252)



54 CONCENTRATION

Portable Refractometers
ISQ-RM30
(page 252)



55 TEMPERATURE

Infrared Thermometers
9110-
(page 249)





INSIZE DO (BRAZIL) LTDA.

Add: Rua Julio de Castilhos,
1014/1016-Belenzinho
CEP 03059-000-Sao Paulo-SP-Brazil
Tel: +55-11-20812412
Fax: +55-11-20812901
E-mail: brazil@insize.com
Website: www.insize.com.br



INSIZE INC. (USA)

Add: 3492 Diversified Dr. Loganville GA 30052
Tel Local: +1-470-240-2520
Tel Toll-Free: +1-844-520-7668
Fax: +1-470-448-4771
E-mail: sales@insizeus.com
Website: www.insizeus.com



INSIZE (CHINA) CO., LTD.

Add: 80 Xiangyang Road, Suzhou New District,
215009 China
Tel: +86-512-68099993
Fax: +86-512-68085081
E-mail: china@insize.com
Website: www.insize.cn



INSIZE (EUROPE)

Add: Plg. Ugaldeguren I P3-Hall 2
48170-Zamudio (Bizkaia) Spain
Tel: +34-94-4544308
Fax: +34-94-4542452
E-mail: europe@insize.com
Website: www.insize-eu.com



INSIZE (INDIA)

Add: B-14, Ground Floor, Jayraj Complex,
Soni Ni Chawli Cross Road, Odhav,
Ahmedabad, Gujarat-382415, India
Tel: +91-79-65458950, 65404657
Fax: +91-79-22134835
E-mail: india@insize.com
Website: www.insize.in



www.insize.com

Watch operation videos at
<http://www.insize.com/support.php>



Application index
(page 298-306)



Distributed by:



We reserve the right to change or modify the design and specification of products in this catalogue without prior notice.

Copyright © INSIZE CO., LTD. All Rights Reserved.
INSIZE is the registered trademark of INSIZE CO., LTD.